



Made in Italy
Established 1956



BIONDAN®

Precious Memories

1956
2016

Over 60 Years with Passion

General Catalogue

Our cover represents one of our most important values,
a value we have maintained for over 60 years: Passion At Work.

We face all our challenges with this passion.

Passion at Work is one of the highest and most difficult
principles to maintain in an enterprise.

We believe deeply in it and have instilled it in our children and our
colleagues (now and in the future) so that we can face the future
with that deep sense of Quality...quality born of Passion At Work.

For 60 years we have shown this passion - it is the passion we will
continue to show in the future.

Thank you for being on this journey with us.

The Biondan Family

**ORDINE DI PRESENTAZIONE
DEGLI ARTICOLI**

La Vetrina delle Preziose Memorie
Lettere - Libri e Pergamene - Cornici
Borchie - Anelloni e Chiavarde
Combinati - Vasi e Lampade
Cristi e Croci - Applicazioni - Targhe
Statue - Urne - Vetrate - Porcellane

Tutti i lumini/ceri rappresentati nelle foto
dimostrative delle lampade non sono
inclusi nel prezzo.

**PRESENTATION ORDER
OF ARTICLES**

The Showcase of Precious Memories
Letters - Books and Parchments
Frames - Studs - Masonry Handles and
Marble Holders - Combined Units -
Vases and Lamps - Christs and Crosses
Applications - Reliefs - Statues - Urns
Artistic Windows - Porcelain

All battery lights/wax candles depicted in the
candleholders are not included in the price.

**ORDRE DE PRÉSENTATION
DES ARTICLES**

La Vitrine de Precious Memories - Lettres
Livres/Parchemins - Cadres/Rosaces
Anneaux/Attaches de Colombarium
Vases/Lampes - Christs/Croix
Applications - Plaques - Statues
Urnes - Vitraux - Porcelaine

Toutes les bougies et systèmes à piles
photographiés avec les lampes ne sont
pas compris dans le prix.



*Valori, che il tempo non cambia
e che abbiamo cominciato a comunicare nel 1956*



1959



1967



1968



1971



1974



1976



1987



1987



1990



2005



2007



2015





Un'azienda familiare con la passione per l'Ecceellenza, la Qualità e l'Innovazione.

La ditta BIONDAN SpA è stata fondata nel 1956, dalla piccola officina nel garage sotto casa, a più di 56.000 mq di attività produttiva. Una storia che continua da oltre 50 anni e che ha portato la BIONDAN ad essere oggi un'importante realtà nel settore funerario con filiali e concessionari in Europa e nel mondo. Le sfide che la BIONDAN ha saputo cogliere e superare nel tempo, ne hanno messo in evidenza il carattere dinamico e la capacità di assecondare ed anticipare il mercato, senza dimenticare il patrimonio artistico che caratterizza la sua produzione. Con BIONDAN l'arte del bronzo si è fatta impresa moderna, capace di pensare in modo universale esprimendo nelle proprie opere sentimenti che appartengono a tutti. La BIONDAN è sinonimo di design italiano in tutto il mondo, ogni singolo pezzo viene progettato e realizzato interamente in Italia.

Alla BIONDAN tutto è Made in Italy. La cura del particolare, la versatilità delle proposte, la varietà delle finiture, manifestano la serietà di una azienda che da sempre opera ai massimi livelli di professionalità.

A World-Wide Group

BIONDAN SpA, founded in 1956, has become a world leader in bronze memorialization and funerary art products and has gained a reputation for professional integrity, fine artistic designs and highly skilled European craftsmanship. BIONDAN uses its skills in artistic bronze work in many high quality ways. By exploiting a state of the art foundry facility, together with the immense skills of its staff, the company is able to work on highly demanding projects in terms of creativity and size.

BIONDAN SpA offers a full range of over 7,000 Bronze Mausoleum and monument products, Bronze and KOSMOLUX™ statuary, glass-fronted niches, urns and photo-ceramic pictures. BIONDAN's other subsidiary, KOSMOLUX™, produces works of art in reconstituted Carrara Marble which have been proven to withstand the harsh environmental conditions and stand the test of time.





Un World-Wide Groupe

Du petit atelier du garage dans le sous sol de la maison, à plus de 56.000 m² d'activité productive. Une histoire qui continue depuis plus de 50 ans, et qui a amené la Société BIONDAN à être aujourd'hui un acteur majeur du secteur du Funéraire, avec des filiales et des concessionnaires en Europe et dans le monde.

Les défis que la Société BIONDAN a rencontré et surmonté, ont mis en évidence son dynamisme et ont démontrés son aptitude à anticiper les tendances du marché, tout en préservant le patrimoine artistique qui caractérise sa production. Avec la Société BIONDAN, l'art du bronze c'est modernisée. A travers ses œuvres, BIONDAN est capable d'exprimer d'une façon universelle les sentiments de tous. La Société BIONDAN est synonyme de Design Italien dans le monde entier. Chaque œuvre est élaborée et fabriquée entièrement en Italie.

Chez BIONDAN tout est MADE IN ITALY. Le souci du détail, la diversité des finitions, la versatilité des propositions, sont autant de d' exigences qui démontrent le sérieux et la capacité d'une entreprise qui depuis toujours travaille à un haut niveau de professionnalisme.





FUSIONE A TERRA | SAND CASTING | LA FUSION A LA TERRE

Esigenze produttive e qualitative si incontrano nella fusione a terra. In questo processo il bronzo viene colato per forza gravitazionale in una forma realizzata in sabbia refrattaria che, dopo la solidificazione, viene rotta per recuperare la fusione. I pezzi così ottenuti sono in un unico blocco di fusione, l'assenza di saldature conferisce ad ogni pezzo maggior prestigio e valore.

A demand for both production and quality are combined in SAND casting. During this process, bronze is cast via gravitational force into a shape produced in fireproof sand which, after solidification, is broken to recover the cast piece. Items are thus produced in a single cast block, the fact that there is no welding makes each piece more prestigious and valuable.

C'est un procédé qui permet de concilier les exigences de la production et la qualité. Avec ce procédé, le bronze est coulé dans un moule réalisé en sable réfractaire, qui après solidification, sera rompu afin de récupérer la fusion. Les pièces ainsi obtenus sont en un seul bloc de fusion. L'absence de soudure confère à chaque article un certain prestige et une certaine valeur.



CERA PERSA | LOST WAX | LA CIRE PERDUE

La più antica e prestigiosa forma di fusione del bronzo. Oggi come oltre mille anni fa, il modello in cera viene ricoperto da materiale refrattario e fatto sciogliere in fornace, così da lasciare un vuoto che il bronzo fuso andrà a riempire. L'involucro, detto muffola, verrà poi delicatamente rotto per recuperare il pezzo fuso. Un processo lungo ed artigianale, per realizzare pezzi unici destinati a durare oltre il tempo.

Lost wax is the oldest and most prestigious form of bronze casting. Today, as over a thousand years ago, the wax model is covered in fireproof materials and melted in a furnace, in order to leave an empty space that the cast bronze will successively fill. The cover, called a muffle, is then delicately broken in order to recover the cast piece. This special artisan process produces unique, long-lasting pieces.

C'est la méthode de fusion du bronze la plus ancienne et la plus prestigieuse. Aujourd'hui, comme depuis un millier d'années, le modèle à la cire est recouvert d'un matériau réfractaire et fondu dans la fournaise afin de laisser un vide qui sera rempli par le bronze en fusion. L'enveloppe est ensuite délicatement cassée afin de récupérer l'article ainsi fondu. C'est un procédé long et artisanal qui permet de réaliser des pièces uniques destinées à durer dans le temps.















FINITURA CUBIC MARMORIZZATA CUBIC MARBLED FINISH | CUBE EN MARBRE FINITION

La finitura Cubic marmorizzata si ottiene attraverso bagno ad immersione. Il pezzo in bronzo viene ricoperto da una speciale vernice a 200 gradi che farà da supporto alla fase successiva di cubicatura. Attraverso l'immersione del pezzo in una speciale vasca contenente il prodotto marmorizzante, si ottiene una perfetta adesione alla superficie del materiale immerso. Si possono ottenere diverse colorazioni o tipi di marmo, a scelta tra Botticino, Verde Alpi e Bianco Carrara.

Cubic marbled finish is produced by dipping. Bronze pieces are covered in a special paint at 200 degrees which will act as a support for the following cubing stage. The piece is dipped into a special tank containing the marbling product to ensure perfect adhesion to the surface of the dipped material. Different colours or types of marble can be produced, and clients can choose from Botticino, Verde Alpi or Bianco Carrara.

La finition Cubic marbrée s'obtient par immersion. L'article en bronze sera recouvert d'un vernis spécial à 200 degré qui servira de base à phase de marbrure. Au travers de l'immersion du produit, dans des bacs spéciaux, on obtient une adhésion parfaite sur la surface du produit immergé. De cette façon, on peut obtenir différentes colorations marbrées, comme le Vert des Alpes, Blanc de Carrare ou New Botticino.

INDICE · INDEX

	LA VETRINA DELLE PREZIOSE MEMORIE The Showcase of Precious Memories	1PM
	VASI E LAMPADE · VASES AND LAMPS	2PM
	LETTERE · LETTERS	106PM
	BRONZO · BRONZE	001
	CRISTI E CROCI · CHRISTS - CROSSES	120
	APPLICAZIONI · ORNAMENTS	133
	TARGHE · PLAQUES	164
	STATUE · STATUES	175
	CUBIC	235
	VERDE ALPI · VERDE ALPI FINISH	237
	BIANCO CARRARA · BIANCO CARRARA FINISH	257
	NEW BOTTICINO	277
	SMALTATO BIANCO · WHITE ENAMEL FINISH	311
	BRONZO DIPINTO A MANO · HAND PAINTED BRONZE	334
	BRILLIANT BLACK	350
	NEROLUCIDO	360
	PALLADIO	375
	ACCIAIO INOX · STAINED GLASS STEEL	390
	URNE · URNS	440
	ACCESSORI · ACCESSORIES	456
	VETRATE · STAINED WINDOWS	466
	PORCELLANE · PORCELAIN	475
	MARMORIZZATO BOTTICINO · BOTTICINO FINISH	476
	MARMORIZZATO BIANCO CARRARA · BIANCO CARRARA FINISH	482
	PORCELLANA BIANCA · WHITE PORCELAIN	487
	PORCELLANA BOTTICINO · BOTTICINO PORCELAIN	520
	INDICE ANALITICO · INDEX	542

INDICE PREZIOSE MEMORIE

Precious Memories index

VASI E LAMPADE · VASES AND LAMPS

BRONZO DIPINTO A MANO · HAND PAINTED BRONZE	2PM
BRONZO · BRONZE	3PM
COMPOSIZIONI FLOREALI · BRONZE FLOWERS	42PM
ARTICA	44PM
CUBIC	46PM
VERDE ALPI · VERDE ALPI FINISH	
BIANCO CARRARA · BIANCO CARRARA FINISH	
NEW BOTTICINO	
SMALTATO BIANCO · WHITE ENAMEL FINISH	82PM
BRILLIANT BLACK	93PM
NEROLUCIDO	95PM
ACCIAIO INOX · STAINLESS STEEL	96PM

LETTERE · LETTERS

BRONZO · BRONZE	106PM
CUBIC	111PM
VERDE ALPI · VERDE ALPI FINISH	
BIANCO CARRARA · BIANCO CARRARA FINISH	
NEW BOTTICINO	
SMALTATO BIANCO · WHITE ENAMEL FINISH	117PM
BRILLIANT BLACK	118PM
NEROLUCIDO PALLADIO	119PM
ACCIAIO INOX · STAINLESS STEEL	120PM

Legenda codice articolo · Legend article code



Attacco a parete
Wall Mounted



Attacco a terreno
Base Mounted



Ossari
Niches · Columbaria



Fusione a cera persa
Lost wax casting



Fusione a terra
Sand casting

La Vetrina delle
Preziose Memorie
The Showcase of Precious Memories



serie *Global*

Pag. 335



Bronzo dipinto a mano
Hand painted bronze

La Vetrina delle
Preziose Memorie



2PM

serie Global

Pag. 60



La Vetrina delle
Preziose Memorie

3PM



serie *Camelia*

Pag. 89



4PM

La Vetrina delle
Preziose Memorie

serie Sciocco

Pag. 90



Fusione in bronzo "alta qualità"
Bronze casting "high quality"



La Vetrina delle
Preziose Memorie

5PM



serie Viola

Pag. 91



Fusione in bronzo "alta qualità"
Bronze casting "high quality"



La Vetrina delle

Preziose Memorie



GPM

serie *Creta*

Pag. 91



Fusione in bronzo "alta qualità"
Bronze casting "high quality"



La Vetrina delle
Preziose Memorie

7PM



serie Cuore

Pag. 92



Fusione in bronzo "alta qualità"
Bronze casting "high quality"



La Vetrina delle

Preziose Memorie



8PM

serie Margherita

Pag. 92



Fusione in bronzo "alta qualità"
Bronze casting "high quality"



La Vetrina delle
Preziose Memorie

9PM



serie *Egadi*

Pag. 61



10PM

La Vetrina delle
Preziose Memorie

serie Capri

Pag. 62



La Vetrina delle
Preziose Memorie

11PM



serie *Dune*

Pag. 63



12PM

La Vetrina delle
Preziose Memorie

serie *Solaris*

Pag. 63



La Vetrina delle
Preziose Memorie

13PM



serie *Rose*

Pag. 75



Disponibile anche nelle versioni
Bronzo anticato e Verde Pompeiano.

Also available in antique Bronze and
Verde Pompeiano.



serie *Rose antica* Pag. 74

serie *Rose verde pompeiano* Pag. 76



14PM

La Vetrina delle
Preziose Memorie

serie Athena

Pag. 83



*La Vetrina delle
Preziose Memorie*

15PM



serie
Bois

serie
Bois Doré

Pag. 72



16PM

La Vetrina delle
Preziose Memorie

serie Onda

Pag. 64



*La Vetrina delle
Preziose Memorie*

17PM



serie Decò

Pag. 67



18PM

*La Vetrina delle
Preziose Memorie*

serie *Cirri*

Pag. 73



Disponibile anche nella versione
Bronzo anticato.

Also available in antique Bronze.

serie *Cirri antica* Pag. 74



La Vetrina delle
Preziose Memorie

19PM



serie Orum

Pag. 66



20PM

*La Vetrina delle
Preziose Memorie*

serie Vela

Pag. 79



La Vetrina delle
Preziose Memorie

21PM



serie Alliance

Pag. 67



22PM

*La Vetrina delle
Preziose Memorie*

serie Delphi

Pag. 85



*La Vetrina delle
Preziose Memorie*

23PM



serie All. Oro *Alliance*

Pag. 65



24PM

La Vetrina delle
Preziose Memorie

serie Plissé

Pag. 86



*La Vetrina delle
Preziose Memorie*

25PM



serie Luna

Pag. 70



26PM

*La Vetrina delle
Preziose Memorie*

serie *Ulivo*

Pag. 70



La Vetrina delle
Preziose Memorie

27PM



serie
Spiga

Pag. 78



28PM

La Vetrina delle
Preziose Memorie

serie Libre

Pag. 71



*La Vetrina delle
Preziose Memorie*

29PM



serie Quadrifoglio

OS
OSSARI

Pag. 80



serie Alpi
Pag. 71



30PM

La Vetrina delle
Preziose Memorie

serie *Athena Oro*

Pag. 84



La Vetrina delle
Preziose Memorie

31PM



serie
Impero

Pag. 64



32PM

La Vetrina delle
Preziose Memorie

serie Corinto

Pag. 78



La Vetrina delle
Preziose Memorie

33PM



serie Pegaso

Pag. 68



34PM

*La Vetrina delle
Preziose Memorie*

serie *Scudo*

Pag. 80



La Vetrina delle
Preziose Memorie

35PM



serie Torciaglione

Pag. 81



36PM

La Vetrina delle
Preziose Memorie

serie Calla

Pag. 86



La Vetrina delle
Preziose Memorie

37PM



serie Nexus

Pag. 79



38PM

*La Vetrina delle
Preziose Memorie*

serie *Herba*

Pag. 71



La Vetrina delle
Preziose Memorie

39PM



serie Barocco

Pag. 81



40PM

*La Vetrina delle
Preziose Memorie*

serie Iris

Pag. 72



La Vetrina delle
Preziose Memorie

41PM



suggerimenti per

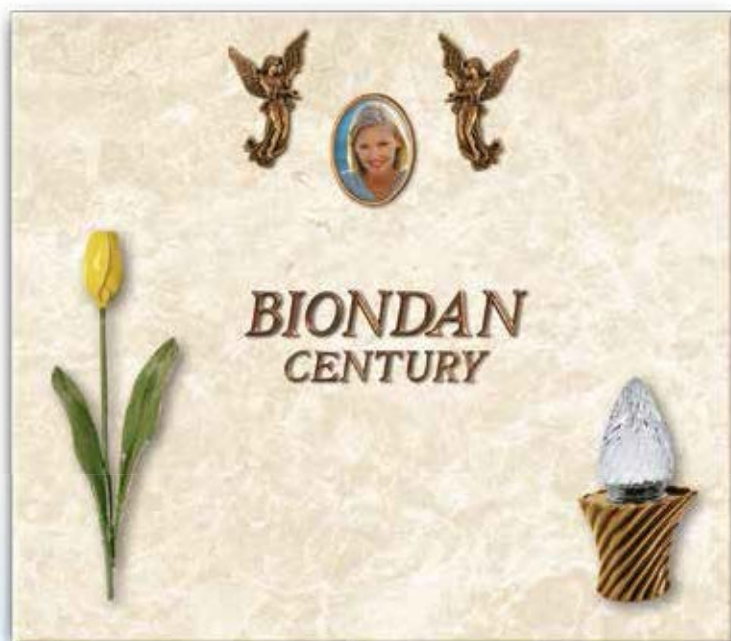

42PM

La Vetrina delle
Preziose Memorie

Composizioni Floreali



Pag. 139



serie *Artica*

Pag. 103

Pag. 415



44PM

La Vetrina delle
Preziose Memorie



La Vetrina delle
Preziose Memorie

45PM



serie
Egadi

Pag. 244

verde alpi



CUBIC
BRONZIAN

serie *Global*

Pag. 244

verde alpi



La Vetrina delle
Preziose Memorie

47PM



serie **Onda**

Pag. 246



verde alpi



serie *Orum*

Pag. 246



La Vetrina delle
Preziose Memorie

49PM



serie *Decò*

Pag. 247



serie *Alliance*

Pag. 247



La Vetrina delle
Preziose Memorie

51PM



serie All. Oro
Alliance

Pag. 248



verde alpi



serie *Delfhi*

Pag. 248



La Vetrina delle
Preziose Memorie

53PM



serie
Cirri

Pag. 245

verde alpi



CUBIC
BRONZIAN

serie **Bois Doré**

Pag. 249

verde alpi



La Vetrina delle
Preziose Memorie

55PM



serie **Libre**

Pag. 249



verde alpi



CUBIC
BRONZIAN

serie Athena Oro

verde alpi

Pag. 250



La Vetrina delle
Preziose Memorie

57PM



serie Egadi

Pag. 265



serie Global

Pag. 265



La Vetrina delle
Preziose Memorie

59PM



serie *Onda*

Pag. 267



serie *Orum*

Pag. 267

bianco carrara



La Vetrina delle
Preziose Memorie

61PM



serie
Decò

Pag. 268



La Vetrina delle
Preziose Memorie



CUBIC
BONDANI

serie *Alliance*

Pag. 268

bianco carrara



La Vetrina delle
Preziose Memorie

63PM



serie All. Oro Alliance

Pag. 269



CUBIC
BORGIANI

serie *Delphi*

Pag. 270

bianco carrara



La Vetrina delle
Preziose Memorie

65PM



serie
Cirri*Pag. 266*

serie **Bois Doré**

Pag. 270



La Vetrina delle
Preziose Memorie

67PM



serie
Libre*Pag. 270*

La Vetrina delle
Preziose Memorie



CUBIC
BIONDANI

serie Athena Oro

bianco carrara

Pag. 271



La Vetrina delle
Preziose Memorie

69PM



serie
Egadi

Pag. 285



new bottecinò



serie Global

Pag. 285



La Vetrina delle
Preziose Memorie

serie
Onda

Pag. 287

new bottecinò



serie *Orum*

Pag. 287



La Vetrina delle
Preziose Memorie

serie
Decò

Pag. 288



La Vetrina delle
Preziose Memorie

serie *Alliance*

Pag. 288



La Vetrina delle
Preziose Memorie

75PM



serie All. Oro
Alliance

Pag. 289



new botticino



serie *Delfhi*

Pag. 289



La Vetrina delle
Preziose Memorie

serie
Cirri

Pag. 286

new botticino



CUBIC
BORGIANI

serie **Bois Doré**

Pag. 290

new botticino



La Vetrina delle
Preziose Memorie

79PM



serie **Libre**

Pag. 290



new botticino



CUBIC
BRONZIAN

serie Athena Oro

new botticino

Pag. 291



La Vetrina delle
Preziose Memorie

81PM



serie *Cirri*

Pag. 317



serie *Solaris*

Pag. 318

smaltato bianco



La Vetrina delle
Preziose Memorie

83PM



serie *Dune*

Pag. 318



84PM

La Vetrina delle
Preziose Memorie

serie *Rose*

Pag. 318

smaltato bianco



La Vetrina delle
Preziose Memorie

85PM



serie Egadi

Pag. 319



serie
Capri

Pag. 319

smaltato bianco



La Vetrina delle
Preziose Memorie

87PM



serie *Onda*

Pag. 320



88PM

La Vetrina delle
Preziose Memorie

serie Orum

Pag. 320

smaltato bianco



La Vetrina delle
Preziose Memorie

89PM



serie *Impero*

Pag. 321



serie *Decò*

Pag. 321

serie **Global**

Pag. 322

smaltato bianco



La Vetrina delle
Preziose Memorie

91PM



serie
Libre



Pag. 322



serie
Delphi



Pag. 322

La Vetrina delle
Preziose Memorie



serie
Dune

Pag. 352

brilliant black



La Vetrina delle
Preziose Memorie

93PM



serie
Solaris

Pag. 352

brilliant black



94PM

La Vetrina delle
Preziose Memorie

serie **new** *Global*
Pag. 364
nerolucido

nerolucido



La Vetrina delle
Preziose Memorie

95PM



serie *Croix*

Pag. 410



serie
Style

Pag. 407

acciaio inox



serie.
Goccia

Pag. 407

La Vetrina delle
Preziose Memorie

97PM



serie Corfù

Pag. 403



serie
Elisse

Pag. 409

serie
Nastro

Pag. 407



acciaio inox



La Vetrina delle
Preziose Memorie

99PM



serie *Libre*

Pag. 408



serie *Bois Inox*

Pag. 408

serie Torciglione

Pag. 408

acciaio inox



Acciaio inox microfuso

La Vetrina delle
Preziose Memorie

101PM



serie *Universale*

Pag. 412



serie *Triade*

Pag. 413

acciaio inox



La Vetrina delle
Preziose Memorie

103PM



serie Bouquet

Pag. 405



serie Minimal

Pag. 405



104PM

La Vetrina delle
Preziose Memorie

Aserie Armonia

  Pag. 414

acciaio inox



serie Scrigno

 Pag. 414

La Vetrina delle
Preziose Memorie

105PM



Epoca

Epoca

Pag. 2

Epoca Saldato Pag. 1 · Epoca Adesivo | Adhesive Pag. 12

GIULIETTA

Giulietta

Pag. 1



CENTURY

Century

Pag. 4

SCALIGERO

Scaligero

Pag. 4

Adesivo | Adhesive Pag. 13

NORMANNO

Normanno

Pag. 5



106PM

*La Vetrina delle
Preziose Memorie*

MODERNO

Moderno

Pag. 6

BASTONE

Bastone

Pag. 6

ROMANO P

Romano patinato

Pag. 7

ROMANO S

Romano spazzolato

Pag. 7

Adesivo | Adhesive Pag. 13

ROMANO T

◆ **Romano traforato** Pag. 8

*La Vetrina delle
Preziose Memorie*

107PM



Corsivo T

◆ **Corsivo traforato** Pag. 8

Corsivo L

◆ **Corsivo saldato** Pag. 9

Corsivo Aa

◆ **Corsivo autocomponibile** Pag. 9

ESEMPIO CON LETTERE ROMANO E MODERNO
EXAMPLE WITH ROMANO AND MODERNO LETTERS

ABC ABC

◆ **Lettere saldate su asta** Pag. 9
Letters welded on a bar

MODERNO A

Moderno altorilievo Pag. 5



108PM

La Vetrina delle
Preziose Memorie

BIONDAN

◆ **Focus traforato** Pag. 10

Biondan

◆ **Modus traforato** Pag. 10

Biondan

◆ **Romano corsivo traforato** Pag. 10

BIONDAN

◆ **Avant traforato** Pag. 10

SCALIGERO

◆ Scaligero dorato Pag. 14

ROMANO D

◆ Romano dorato Pag. 14

Corsiva I

◆ Corsivo saldato dorato Pag. 15

Corsiva A2

◆ Corsivo autocomponibile dorato Pag. 15



BIONDAN

◆ **Focus traforato** Pag. 237

Biondan

◆ **Modus traforato** Pag. 237

Biondan

◆ **Romano corsivo traforato** Pag. 237

BIONDAN

◆ **Avant traforato** Pag. 237

Epoca

Epoca

Pag. 238

Epoca Saldata Pag. 238

SCALIGERO

Scaligero

Pag. 239

ROMANO T

◆ Romano traforato

Pag. 239

Corsivo T

◆ Corsivo traforato

Pag. 240

Corsivo S

◆ Corsivo saldato

Pag. 240

BIONDAN

◆ **Focus traforato** Pag. 257

Biondan

◆ **Modus traforato** Pag. 257

Biondan

◆ **Romano corsivo traforato** Pag. 258

BIONDAN

◆ **Avant traforato** Pag. 258

Epoca

Epoca

Pag. 259

Epoca Saldata Pag. 259

SCALIGERO

Scaligero

Pag. 260

ROMANO T

◆ **Romano traforato**

Pag. 260

Corsivo T

◆ **Corsivo traforato**

Pag. 261

Corsivo S

◆ **Corsivo saldato**

Pag. 261

BIONDAN

◆ **Focus traforato** Pag. 277

Biondan

◆ **Modus traforato** Pag. 277

Biondan

◆ **Romano corsivo traforato** Pag. 278

BIONDAN

◆ **Avant traforato** Pag. 278

Epoca

Epoca

Pag. 279

Epoca Saldata Pag. 279

SCALIGERO

Scaligero

Pag. 280

ROMANO T

◆ **Romano traforato**

Pag. 280

Corsivo T

◆ **Corsivo traforato**

Pag. 281

Corsivo S

◆ **Corsivo saldato**

Pag. 281

Epoca

◆ **Epoca saldato**

Pag. 312

CENTURY

Century

Pag. 312

SCALIGERO

Scaligero

Pag. 312

Corsivo I

◆ **Corsivo saldato**

Pag. 313

BIONDAN

◆ **Focus traforato** Pag. 351

Biondan

◆ **Modus traforato** Pag. 351

Biondan

◆ **Romano corsivo traforato** Pag. 351

BIONDAN

◆ **Avant traforato** Pag. 351

SCALIGERO

Scaligero

Pag. 361

new

nerolucido

Corsivo T

◆ Corsivo Traforato

Pag. 361

new

Epoca

Epoca

Pag. 376

palladio

CENTURY

Century

Pag. 377

ROMANO T

◆ Romano traforato

Pag. 377

La Vetrina delle
Preziose Memorie

119PM



SCALIGERO

■ ■ Scaligero Pag. 391

Corsiva A6

■ ■ Corsivo autocomponibile Pag. 391

BASTONE

Bastone Pag. 392

ROMANO

Romano Pag. 392

MODERNO

Moderno

Pag. 393

ROMANO S

Romano stretto

Pag. 393

Corsivo t

◆ **Corsivo traforato**

Pag. 394

SIMPLEX

Simplex

Pag. 395

Adesivo | Adhesive Pag. 395

La Vetrina delle
Preziose Memorie

121PM



SCRIPTA PROGRAM

Un programma avanzato di composizione caratteri che consente di ottenere da uno stesso testo, variando automaticamente lo spazio tra le lettere, scritte di diversa lunghezza ottimizzando gli avvicinamenti complessi tra lettere come A e V, L e T.

Questa funzione permette al marmista di sfruttare al meglio lo spazio a disposizione, creando composizioni equilibrate, nella misura desiderata.

Scripta is an advanced letter composition program that makes different length inscriptions from the same text by automatically changing the space between letters and optimizing vicinities between letters such as A and V, L and T.

Stonemasons can use this function to take advantage of available space, generating well-balanced compositions in the desired size.

Caratteri e misure disponibili SCRIPTA Available SCRIPTA characters and sizes

h cm	Scaligero	Normanno	Romano	Moderno altorilievo	Bastone	Moderno	Century	Simplex inox	Romano inox	Scaligero inox
1,5	•		•				•			
2			•		•					
2,5	•	•	•		•	•	•	•	•	•
2,7										
3	•	•	•	•	•	•	•			
3,5								•	•	
4	•	•	•	•	•	•	•			•
4,5								•	•	
5	•	•	•	•	•	•	•			
5,5								•	•	
6		•	•			•				
7	•									
8		•	•	•						
10										

Scripta Program permette, tramite un PC ed una stampante, di ottenere la stampa dei testi che serviranno da traccia per la perforazione del marmo.

Scripta Program can make, using a computer and matrix printer, print-outs of texts that can be used as templates for drilling the marble.



ABCDEFGHI
 JKLMNOPQR
 STUVWXYZ
 1234567890

★ ✚ † Α Ω , · - ∨

70 69 67 66 33 62 63 61 64 76

, · - ∨

Art. 7580
 h. 1,5 - 2,5 - 4 - 5



Giulietta

Art. 7570 - h. 1,5
 ● ✚ ✚ ■ Æ Ð Ð L Ø

Art. 7572 - h. 2,5
 ● ✚ ✚ ■

Art. 7574 - h. 4
 ● ✚ ✚ ■

Art. 7575 - h. 5
 ● ✚

Art. 7577 - h. 8
 ●

Per quantità inferiori alla confezione e forniture di dicitore, aumento del 20% fino a 6 cm.

Legenda simboli: ● Lettere / ✚ Numeri / ★ Stelle - Croci / † Alpha (66) - Omega (33) / ■ Stelle (70) - Croci (69)

20% surcharge for any order less than the minimum requirement and for specific words up to 6 cm.

Symbols: ● Letters / ✚ Figures / ★ Stars - Crocasses / † Alpha (66) - Omega (33) / ■ Stars (70) - Crocasses (69)

Scritte personalizzate in un unico pezzo con numeri e segni saldati su asta
 Names welded in one piece only and numbers and punctuation welded on a bar

Epoca saldata

2013

ESEMPIO numeri
 su asta h. 2,7

◆ Art. 7626 - h. 6 - 2,7

2013

ESEMPIO numeri
 su asta h. 4

◆ Art. 7826 - h. 8 - 4

, · - ∨

Segni sciolti

Art. 7366 - h. 6 - 2,7

Art. 7477 - h. 8 - 4

Epoca Saldata

A a a

Iniziale maiuscola
Capital

Minuscola
Small

Terminali
Ending

Epoca

Epoca

A a B b C c D d E e F f
G g H h I i J j K k L l
M m N n O o P p Q q R r
S s T t U u V v W w X x
Y y Z z

72

73

65

Maiuscole
Capitals

Minuscole
Small letters

Terminali
Ending letters

Segni e iniziale
Punctuation and initial tale

Art. 7358 - h. 6

Art. 7359 - h. 2,7

Art. 7360 - h. 2,7

Art. 7366 - h. 6 - 2,7

Art. 7473 - h. 8

Art. 7474 - h. 4

Art. 7475 - h. 4

Art. 7477 - h. 8 - 4



77 61 76 64 63 62

Sistema di montaggio
Le lettere vengono fornite sciolte con micro viti a scomparsa
Mounting system
Loose letters are supplied with flat-head screws

Esempio

77
Iniziale per lettere minuscole
Initial tale for small letters
Art. 7366-77 h. 2,7
Art. 7477-77 h. 4

Lettera terminale
Ending letter without coupling pin
Art. 7360 h. 2,7
Art. 7475 h. 4

6,5 9,0	7,6 10,6	5,8 8,3	6,0 6,5	4,6 6,3	4,2 6,5	5,2 7,2	8 11,1	3,8 7,7	5,8 7,7
A D H N R W	B	C	E	F J Q S Y Z	G T V	L P U	M	O I	X K

Per quantità inferiori alla confezione e forniture di diciture, aumento del 20% fino a 6 cm.
20% surcharge for any order less than the minimum requirement and for specific words up to 6 cm.



66 33 68 70 67

Art. 7361 - h. 2,7

Art. 7476 - h. 4



Particolare fissaggio con perni
Example of number with pins



66 33 68 70 67

Art. 7362 - h. 2,7



Art. 7366-60
Punto per barretta da abbinare a numeri h 2,7
Dot for bar suitable for numbers h 2,7 cm

Esempio
Example



Art. 7421
Barretta cm. 10 - max 4 alloggi
Bar 10 cm. - max 4 lodgements

Esempio
Example

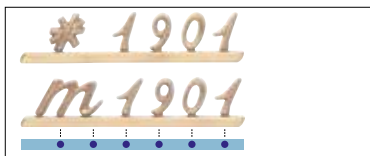

Art. 7422
Barretta cm 17 - max 6 alloggi
Bar 17 cm. - max 6 lodgements

Esempio
Example

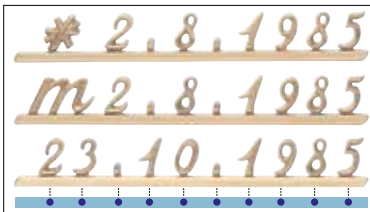

Art. 7423
Barretta cm 27 - max 10 alloggi
Bar 27 cm. - max 10 lodgements

Esempio
Example

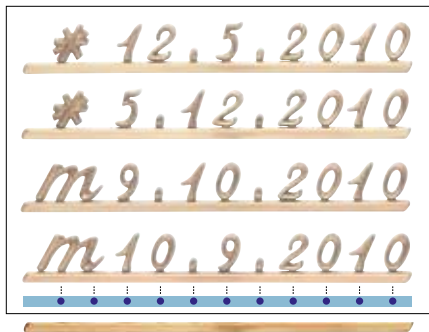

Art. 7424
Barretta cm 29,5 - max 11 alloggi
Bar 29,5 cm. - max 11 lodgements

Esempio
Example

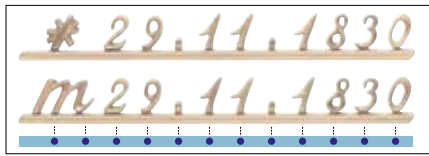

Art. 7425
Barretta cm 32 - max 12 alloggi
Bar 32 cm. - max 12 lodgements

Per un fatto estetico, due date di lunghezze diverse verranno posizionate su due aste di pari lunghezza ovvero sull'asta più lunga.

In case of two dates (Birth and Death) with different lengths, for aesthetic reasons the dates will be positioned on two bars of the same length, i.e. the longest.



Retro della barretta con visione del numero degli alloggi
Back side of the bar with view of lodgments

Art. 7359
Art. 7474

a d g u	b e	f	yz	w	t	r o k	i
p q v n	c s	l	h x	m	j	u	

Per quantità inferiori alla confezione e forniture di diciture, aumento del 20% fino a 6 cm.
20% surcharge for any order less than the minimum requirement and for specific words up to 6 cm.

Art. 7591 - h. 1,5
●**x ÆÐÐLØ

Art. 7221 - h. 2,5
●**x ÆÐÐLØ

Art. 7222 - h. 3
●**x ÆÐÐLØ

Art. 7223 - h. 4
● ÆÐÐLØ

Art. 7224 - h. 5
● ÆÐÐLØ

A B C D E F G H I
J K L M N O P Q R
S T U V W X Y Z
Æ Ð Ð L Ø
65 59 71 72 73
1 2 3 4 5 6 7 8 9 0

g e o - v
Art. 7226 - Segni

g e o - v ★ †
62 63 61 64 76 70 67

Art. 7590 - h. 1,5
●**■ ÆÐÐLØ

Art. 2390 - h. 2,5
●**■ ÆÐÐLØ

Art. 2391 - h. 3
●**■ ÆÐÐLØ

Art. 2392 - h. 4
●* ÆÐÐLØ

Art. 2393 - h. 5
● ÆÐÐLØ

Art. 2394 - h. 7
● L

Art. 2395 - h. 10
●

g e o - v ■ ■
Art. 2396
Segni - h. 1,5-2,5-3-4-5

Art. 2397
Segni - h. 7-10

A B C D E F G H I
J K L M N O P Q R
S T U V W X Y Z
Æ Ð Ð L Ø
65 59 71 72 73
1 2 3 4 5 6 7 8 9 0
* * † g e o - v ■ ■
68 70 67 62 63 64 61 76 75 74
STANDARD

A B C D E F G H I
 J K L M N O P Q R R̥
 S T U V W X Y Z Ł Đ
 1 2 3 4 5 6 7 8 9 0 * † ’ ’̇ • - -̇ ∨ Æ Ø

Art. 2572 - h. 2,5
 ● ** Æ Þ Đ Ł

Art. 2573 - h. 3
 ● ** Æ Þ Đ Ł

Art. 2574 - h. 4
 ● ** Þ Đ Ł

Art. 2575 - h. 5
 ● Þ Đ Ł

Art. 2576 - h. 6
 ●

Art. 2577 - h. 8
 ●

Art. 2578 - h. 10
 ●

’ ’̇ • - -̇ ∨

Art. 7096 - h. 2,5-3

Art. 2579 - h. 2,5-3-4-5

Art. 2580 - h. 6-8-10

Normanno spazzolato

A B C D E F G H I
 J K L M N O P Q R
 S T U V W X Y Z Ł
 1 2 3 4 5 6 7 8 9 0 * † ’ ’̇ • - -̇ ∨

Art. 1208 - h. 3
 ● * x L

Art. 1209 - h. 4
 ● * x

Art. 1210 - h. 5
 ● L

Art. 1213 - h. 8
 ●

’ ’̇ • - -̇ ∨

Art. 1211

Moderno altorilievo rettificato

Per quantità inferiori alla confezione e forniture di dicitore, aumento del 20% fino a 6 cm.

Legenda simboli: ● Lettere / * Numeri / ✱ Stelle - Croci

20% surcharge for any order less than the minimum requirement and for specific words up to 6 cm.

Symbols: ● Letters / * Figures / ✱ Stars - Crosses

A B C D E F G H I J
 K L M N O P Q R
 S T U V W X Y Z
 1 2 3 4 5 6 7 8 9 0 ★ + Α Ω ‘ ’ • - ∨ -
 62 63 61 64 76 78
 70 69 66 33

Art. 1006 - h. 2,5

● * * +

Art. 1007 - h. 3

● * * +

Art. 1008 - h. 4

● *

Art. 1009 - h. 5

●

Art. 1010 - h. 6

●

’ e • - ∨

Art. 1048

Art. 1016 - h. 2

* *

Art. 1017 - h. 2,5

● * * +

Art. 1018 - h. 3

● * *

Art. 1019 - h. 4

● L

Art. 1020 - h. 5

●

A B C D E F G H I
 J K L M N O P Q R
 S T U V W X Y Z Ł
 1 2 3 4 5 6 7 8 9 0
 ★ ★ ✚ ✚ + Α Ω ‘ ’ • - ∨ -
 62 63 61 64 76 78
 70 70 69 69 69 66 33
 Art. 1018 Art. 1016 Art. 1016 Art. 1017 Art. 1018
 Art. 1017

’ e • - ∨

Art. 1048

A B C D E F G H I J K
 L M N O P Q R S T U
 V W X Y Z Æ Þ Ð Ľ Ø
 65 59 71 72 73
 1 2 3 4 5 6 7 8 9 0 &

★ ✚ ✖ † Α Ω 62 63 61 64 76 74 75 78
 70 69 68 67 66 33
 STANDARD

Art. 7141 - h. 2,5

Art. 1032 - h. 1,5
 ● * * + Æ Þ Ð

Art. 1033 - h. 2
 ● * * + Æ Þ Ð Ľ Ø

Art. 1034 - h. 2,5
 ● * * + ■ Æ Þ Ð Ľ Ø

Art. 1035 - h. 3
 ● * * + ■ Æ Þ Ð Ľ Ø

Art. 1036 - h. 4
 ● * * + ■ Æ Þ Ð Ľ Ø

Art. 1037 - h. 5
 ● * * + Æ Þ Ð Ľ Ø

Art. 1038 - h. 6
 ● * * Æ Þ Ð Ľ

Art. 1039 - h. 8
 ● * * Æ Þ Ð Ľ

Art. 1040 - h. 10
 ● * * Æ Þ Ð Ľ

Art. 1041 - h. 12
 ●

Art. 1042 - h. 15
 ●

☒ -Art. 2079 - h. 20
 ● *

☒ -Art. 2080 - h. 25
 ● *

☒ -Art. 2081 - h. 30
 ● *

☒ -Art. 2083 - h. 50
 ●

Art. 1047 - h. 1,5-2

Art. 1048 - h. 2,5-3-4-5-6

Art. 1050 - h. 8-10

Art. 1051 - h. 12-15

☒ -Art. 1028 - h. 20-25-30

A B C D E F G H I J K
 L M N O P Q R S T U V
 W X Y Z Æ Þ Ð Ľ Ø
 65 59 71 72 73
 1 2 3 4 5 6 7 8 9 0 &

★ ✚ ✖ † Α Ω 62 63 61 64 76 74 75 78
 70 69 68 67 66 33
 STANDARD

Art. 714101 - h. 2,5

Art. 1097 - h. 1,5
 ● * * + Æ Þ Ð

Art. 1098 - h. 2
 ● * * + Æ Þ Ð Ľ Ø

Art. 1151 - h. 2,5
 ● * * + ■ Æ Þ Ð Ľ Ø

Art. 1152 - h. 3
 ● * * + ■ Æ Þ Ð Ľ Ø

Art. 1153 - h. 4
 ● * * + ■ Æ Þ Ð Ľ Ø

Art. 1154 - h. 5
 ● * + Æ Þ Ð Ľ Ø

Art. 1155 - h. 6
 ● * Æ Þ Ð Ľ

Art. 1091 - h. 8
 ● Æ Þ Ð Ľ

Art. 1092 - h. 10
 ● Æ Þ Ð Ľ

Art. 7096 - h. 1,5-2

Art. 1175 - h. 2,5-3-4-5-6

Art. 1255 - h. 8-10

Art. 7313 - h. 1,5

A B C D E F G

Art. 7314 - h. 2

Art. 7315 - h. 2,5

H K L J L M

Art. 7316 - h. 3

Art. 7317 - h. 4

N O P Q R S T

Art. 7318 - h. 5

Art. 7319 - h. 6

U V W X Y Z

Art. 7320 - h. 8

Art. 7321 - h. 10

1 2 3 4 5 6 7 8 9 0

Art. 7325 - Segni

★ † N . M , ; _ . ∨

70

67

62 63 64 61 76

Art. 7290 - h. 1,5

A B C D E F G H I J

Art. 7291 - h. 2

Art. 7292 - h. 2,5

K L M N O P Q R S

Art. 7293 - h. 3

Art. 7294 - h. 4

T U V W X Y Z

Art. 7295 - h. 5

Art. 7296 - h. 6

a b c d e f g h k i j l m

Art. 7297 - h. 8

Art. 7298 - h. 10

n o p q r s t u v w x z

★ † N . M . 1 2 3 4 5 6 7 8 9 0

Art. 7299 - Segni

; e . - ∨
? _ ∨ . /

62 64 76 61 63

A b c d e f g h i l
m n o p q r s t u r e

1 2 3 4 5 6 7 8 9 0

a m u e n o i

★ † ‡ ‹ › ‹ ‹ ‹
70 67 62 63 64 61 76

m 17 7 1993

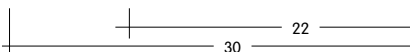

Art. 2724 - h. 5-2,5

Art. 2455 - h. 8-4

-Art. 7012 - h. 20-10

Art. 2723 - h. 2,5
Numeri M N *+ vocali sciolte

Art. 2877 - h. 4
Numeri M N *+ vocali sciolte

9 e • - v
Art. 2057 - h. 2,5

Art. 2888 - h. 4

Art. 7015 - h. 10

Ingombro lettere
vedi tab. pag. 454

Aa Bb Cc Dd Ee

Ff Gg Hh Ii Jj

Kk Ll Mm Nn

Oo Pp Qq Rr Ss

Tt Uu Vv Ww

Xx Yy Zz

1 2 3 4 5 6 7 8 9 0 ★ † ‡ ‹ › ‹ ‹ ‹
70 67 62 63 61 64 76 77



9 e • - v

Art. 2057 - h. 2,5

Art. 7015 - h. 10

Art. 2888 - h. 4

Art. 2054 - h. 5
Mauscole

Art. 2051 - h. 2,5
Minuscole

Art. 2047 - h. 2,5
Minuscole terminali

Art. 2723 - h. 2,5
Numeri M N *+ vocali sciolte

Art. 2874 - h. 8
Mauscole

Art. 2875 - h. 4
Minuscole

Art. 2876 - h. 4
Minuscole terminali

Art. 2877 - h. 4
Numeri M N *+ vocali sciolte

-Art. 7011 - h. 20
Mauscole sciolte

-Art. 7013 - h. 10
Minuscole sciolte

Ingombro lettere
vedi tab. pag. 454

ESEMPIO

A B C D E F G H

A B C D E F G H

5 3 1990 765 763

Art. 2065
h. 1,5

Art. 2068
h. 3

Art. 2071
h. 6

Art. 2066
h. 2

Art. 2069
h. 4

Art. 2072
h. 8

Art. 2067
h. 2,5

Art. 2070
h. 5

Art. 2073
h. 10

I prezzi si riferiscono ai seguenti caratteri saldati su asta: ROMANO, MODERNO, BASTONE, SCALIGERO, CENTURY, NORMANNO. Se non specificato, verrà fornito il carattere Romano Patinato. Per lettere diverse chiedere preventivo.

Prices refer to the following fonts welded on a bar: ROMANO, MODERNO, BASTONE, SCALIGERO, CENTURY, NORMANNO. If not specified, Romano Patinato font will be supplied.



BIONDAN
0123456789

Art. 764015 - h. 1,5
Art. 764020 - h. 2
Art. 764025 - h. 2,5
Art. 764030 - h. 3
Art. 764040 - h. 4
Art. 764050 - h. 5
Art. 764060 - h. 6
Art. 764080 - h. 8
Art. 764099 - h. 10
Art. 764000 - Segni

Biondan
0123456789

Art. 762015 - h. 1,5
Art. 762020 - h. 2
Art. 762025 - h. 2,5
Art. 762030 - h. 3
Art. 762040 - h. 4
Art. 762050 - h. 5
Art. 762060 - h. 6
Art. 762080 - h. 8
Art. 762099 - h. 10
Art. 762000 - Segni

Biondan
0123456789

Art. 763015 - h. 1,5
Art. 763020 - h. 2
Art. 763025 - h. 2,5
Art. 763030 - h. 3
Art. 763040 - h. 4
Art. 763050 - h. 5
Art. 763060 - h. 6
Art. 763080 - h. 8
Art. 763099 - h. 10
Art. 763000 - Segni

BIONDAN
0123456789

Art. 761015 - h. 1,5
Art. 761020 - h. 2
Art. 761025 - h. 2,5
Art. 761030 - h. 3
Art. 761040 - h. 4
Art. 761050 - h. 5
Art. 761060 - h. 6
Art. 761080 - h. 8
Art. 761099 - h. 10
Art. 761000 - Segni



Art. 1034 - h. 2,5

●**+■ÆƒÐƆØ

Art. 1036 - h. 4

●**+■ÆƒÐƆØ

Art. 1029 - h. 6

●*ÆƒÐƆ

Art. 1030 - h. 8

●*

Art. 1031 - h. 10

●*

’ ’ • - ∨

Art. 1048

Per quantità inferiori alla confezione e forniture di diciture, aumento del 20% fino a 4 cm.
20% surcharge for any order less than the minimum requirement and for specific words up to 4 cm.



Art. 2965 - h. 2,5
(con perni filettati)

Art. 2966 - h. 4
(con perni filettati)



Art. 1034 - h. 2,5
●**+

Art. 1035 - h. 3

●**+

Art. 1036 - h. 4

●*

Art. 1037 - h. 5

●*

’ ’ • - ∨

Art. 1048

Per quantità inferiori alla confezione e forniture di diciture, aumento del 20% fino a 6 cm. Disponibili anche adesivi cm 2,5 - 3.

Legenda simboli: ● Lettere / * Numeri / ★ Stelle - Croci / ■ Stelle (68) - Croci (67) / + Alpha (66) - Omega (33)

20% surcharge for any order less than the minimum requirement and for specific words up to 6 cm.

Adhesive version available upon request for letters of 2,5 cm and 3 cm.

Symbols: ● Letters / * Figures / ★ Stars - Crosses / ■ Stars (68) - Crosses (67) / + Alpha (66) - Omega (33)

Epoca



Sistema di montaggio



72

73

65



Art. 7440 - h. 6
Mauscole

Art. 7441 - h. 2,7
Minuscole

Art. 7442 - h. 2,7
Lettere terminali



66 33 68 70 67

Art. 7443 - h. 2,7
Numeri e lettere



77 61 76 64 63 62

Art. 7444
Segni

Tecniche di applicazione delle lettere adesive.

1. La forza di adesione dipende dalla superficie di contatto. Un'adeguata pressione, nell'applicazione, garantisce un'adesione ottimale.
2. Per ottenere la migliore adesione, le superfici devono essere pulite, sgrassate, asciutte ed omogenee.
3. Applicare le lettere a temperature comprese tra i 20°C e i 40°C. Applicazioni a temperature inferiori a 10°C sono sconsigliate, poiché l'adesivo diviene troppo rigido; la bassa temperatura è ininfluente dopo l'applicazione. L'adesivo resiste a temperature comprese tra i -30°C e +110°C.
4. Conservare le lettere non utilizzate in luogo fresco e asciutto.

Instructions for adhesive letters.

1. The quality of the adhesion of letters depends on the condition of the surface on which they are applied and the pressure used.
2. To obtain the best adhesion the surface must be clean, degreased, dry and smooth.
3. Apply the letters at temperatures between 20°C and 40° centigrade. We advise against application at a temperature lower than 10°C as the adhesive becomes too rigid. Low temperatures after the application have no adverse effect because the adhesive once set resists temperatures between -30°C and +110°C.
4. We recommend to store unused letters in a cold and dry place.

Técnicas de aplicación de las letras adhesivas.

1. La fuerza de adhesión depende de la superficie de contacto. Una presión de aplicación adecuada garantiza una adhesión óptima.
2. Para lograr la mejor adhesión, las superficies tienen que estar limpias, desgrasadas, secas y homogéneas.
3. Aplicar las letras con unas temperaturas comprendidas entre 20°C y 40°C. Se desaconseja aplicarlas con unas temperaturas por debajo de 10°C porque el adhesivo se vuelve demasiado rígido; la temperatura baja es irrelevante después de la aplicación. El adhesivo resiste unas temperaturas comprendidas entre -30°C y +110°C.
4. Guárdense las letras inutilizadas en un lugar fresco y seco.

Per le misure d'ingombro vedi tabelle pag. 2-3
Dimension of letters see pag. 2-3

Per quantità inferiori alla confezione e forniture di diciture, aumento del 20% fino a 6 cm.
20% surcharge for any order less than the minimum requirement and for specific words up to 6 cm.

A B C D E F G H I
 J K L M N O P Q
 R S T U V W X Y Z È
 1 2 3 4 5 6 7 8 9 0



Sistema di montaggio

✳ ✚ ◡ ◢ ◣ ◤ ◥ ◦ ◧ ◨ ◩
 70 67 62 63 61 64 76 74 75

Æ Þ Ð Æ Ø
 65 59 71 73

Disponibili senza perni da applicare con silicone.
 Available without pins for mounting with silicone.

Art. 27F1 - h. 2,5
 ● ✳ ✳ Æ Þ Ð Æ Ø

Art. 27F2 - h. 3
 ● ✳ ✳ Æ Þ Ð Æ Ø

Art. 27F3 - h. 4
 ● Æ Þ Ð Æ Ø

Art. 27F4 - h. 5
 ● Æ Þ Ð Æ Ø

◡ ◢ ◣ ◤ ◥ ◦ ◧ ◨ ◩
 Art. 27F5

A B C D E F G H I J K
 L M N O P Q R S T U V
 W X Y Z
 1 2 3 4 5 6 7 8 9 0



Sistema di montaggio

★ ✚ Α Ω ◡ ◢ ◣ ◤ ◥ ◦ ◧ ◨ ◩
 70 69 66 33 62 63 61 64 76 74 75

Art. 29A0 - h. 2,5
 ● ✳ ✳ + Æ Þ Ð Æ Ø

Art. 29A1 - h. 3
 ● ✳ ✳ + Æ Þ Ð Æ Ø

Art. 29A2 - h. 4
 ● + Æ Þ Ð Æ Ø

Art. 29A3 - h. 5
 ● Æ Þ Ð Æ Ø

◡ ◢ ◣ ◤ ◥ ◦ ◧ ◨ ◩
 Art. 29A6

Æ Þ Ð Æ Ø

Disponibili senza perni da applicare con silicone.
 Available without pins for mounting with silicone.

Per quantità inferiori alla confezione e forniture di diciture, aumento del 20% fino a 5 cm.
 Legenda simboli: ● Lettere / ✳ Numeri / ✳ Stelle - Croci / + Alpha (66) - Omega (33)

20% surcharge for any order less than the minimum requirement and for specific words up to 5 cm.
 Symbols: ● Letters / ✳ Figures / ✳ Stars - Crosses / + Alpha (66) - Omega (33)

A B C D E F G H I J K

L M N O P Q R S T U

V W X Y Z Æ Þ Ð Ľ Ø

65 59 71 72 73

1 2 3 4 5 6 7 8 9 0 * ☆ † ' ' ' - ∨

68 70 67

Art. 2900 - h. 2,5
● * ☆ ■ Æ Þ Ð Ľ Ø

Art. 2901 - h. 3
● * ☆ ■ Æ Þ Ð Ľ Ø

Art. 2902 - h. 4
● * Æ Þ Ð Ľ Ø

Art. 2903 - h. 5
● Æ Þ Ð Ľ Ø

‘ ‘ ‘ - ∨

Art. 2904

Legenda simboli: ● Lettere / * Numeri / ☆ Stelle (70) - Croci (69) / ■ Stelle (68) - Croci (67)
Symbols: ● Letters / * Figures / ☆ Stars (70) - Crosses (69) / ■ Stars (68) - Crosses (67)

A B C D E F G H I J K

L M N O P Q R S T U

V W X Y Z Æ Þ Ð Ľ Ø

65 59 71 72 73

1 2 3 4 5 6 7 8 9 0 ☆ ✚ ✨ † ' ' ' - ∨

70 69 68 67

Art. 2920 - h. 2,5
● * ☆ † ■ Æ Þ Ð Ľ Ø

Art. 2921 - h. 3
● * ☆ † ■ Æ Þ Ð Ľ Ø

Art. 2922 - h. 4
● * ☆ † ■ Æ Þ Ð Ľ Ø

Art. 2923 - h. 5
● * † Æ Þ Ð Ľ Ø

Art. 2924 - h. 6
● Æ Þ Ð Ľ

‘ ‘ ‘ - ∨

Art. 2919

A b c d e f g h i l
m n o p q r s t u r e

★ 25 5 1920

† 3 9 1993

Art. 2886 - h. 5-2,5

Art. 2887 - h. 8-4

Segni, numeri sciolti, stella e croce vedere corsivo autocomponibile dorato.
Punctuation, loose numbers, star and cross: see corsivo autocomponibile dorato.

Aa Bb Cc Dd Ee

Ff Gg Hh Ii Jj

Kk Ll Mm Nn

Oo Pp Qq Rr Ss

Tt Uu Vv Ww

Xx Yy Zz

1 2 3 4 5 6 7 8 9 0 * ★ †

68 70 67

Art. 2880
h. 5 Maiuscole

Art. 2881
h. 2,5 Minuscole

Art. 2883 - h. 2,5
Minuscole terminali

Art. 2882 - h. 2,5
Numeri N M * +
vocali sciolte

• • • - -
Art. 2884 - h. 2,5

A richiesta anche h. 8-4.
h. 8-4 can also be produced
upon request.

• • • - -
62 63 61 64 77 76



Art. 2976
h. 13 x 23 - cornice massima applicabile
7 x 9 prezzo escluso cornice

Art. 2978
h. 18 x 29 - cornice massima applicabile
9 x 12 prezzo escluso cornice



Art. 2977
h. 13 x 23 - cornice massima applicabile
7 x 9 prezzo escluso cornice

Art. 2979
h. 18 x 29 - cornice massima applicabile
9 x 12 prezzo escluso cornice



Art. 1492
h. 28 x 36,5

Art. 7051
h. 25,5 x 36 x 24
cornice massima applicabile 11 x 15 (a destra)
cornice massima applicabile 9 x 12 (a sinistra)



Art. 2725
h. 16 x 39 x 29
cornice massima applicabile 11 x 15 (a destra)
cornice massima applicabile 9 x 12 (a sinistra)

Incisione gratuita - Free Engraving Tipo "CD" *Abcdef* Tipo "BM" ABCDEFG Tipo "BL" ABCDEF Tipo "BS" ABCDEFGH
Escluso stemmi e marchi



Art. 297601
h. 13 x 23
Cornice 7 x 9 inclusa



Art. 297602
h. 13 x 23
Cornice 7 x 9 inclusa



Art. 297603
h. 13 x 23
Cornice 7 x 9 inclusa



Art. 297605
h. 13 x 23
Cornice 7 x 9 inclusa



Art. 297606
h. 13 x 23
Cornice 7 x 9 inclusa



Accessorio adesivo

Art. 28A001
h. 13 x 23

Art. 28A002
h. 18 x 29



Accessorio adesivo

Art. 27A001
h. 7 x 10

Art. 27A002
h. 10 x 15

Art. 27A003
h. 11 x 20

Art. 27A004
h. 14 x 23

Art. 27A005
h. 16 x 27



Art. 7068
Coppia di staffe per trasformazione a terreno di libri e targhe



Art. 2905
h. 5,5 x 12

Art. 1519
h. 7 x 10

Art. 1520
h. 10 x 15

Art. 1523
h. 11 x 20

Art. 1524
h. 14 x 23

Art. 1528
h. 16 x 27

-Art. 1536 ■■
h. 26 x 46



Art. 7645 new
h. 10,5 x 12
(pergamena 7 x 10)



Art. 377508 ■■
h. 16 x 21
Marmo escluso
Marble excluded



Supporti per trasformazione pergamene a terreno

Art. 7536 per **Art. 2905-1519-1520-1523**
Art. 7537 per **Art. 1524-1528**

ESEMPIO con Corsivo Saldato applicato (prezzo escluso)

Art. 2677
h. 21 x 31

-Art. 2424 ■■
h. 30 x 50 x 10

-Art. 2422 ■■
h. 30 x 50

-Art. 2425 ■■
h. 35 x 60 x 10

-Art. 2423 ■■
h. 35 x 60



Art. 2693
h. 16 x 24



Art. 2909
h. 17 x 25
base 12 x 8



Incisione rosa compresa nel prezzo

Art. 743701
h. 14 x 23

Art. 743702
h. 11 x 20

Art. 7437
h. 17 x 26



Art. 151901
h. 7 x 10



Art. 151902
h. 7 x 10



Art. 151903
h. 7 x 10



Art. 151904
h. 7 x 10



Art. 151905
h. 7 x 10



Art. 151906
h. 7 x 10



Art. 152001
h. 10 x 15



Art. 152002
h. 10 x 15



Art. 152003
h. 10 x 15



Art. 152004
h. 10 x 15



Art. 152005
h. 10 x 15



Art. 152301
h. 11 x 20



Art. 152302
h. 11 x 20



Art. 152303
h. 11 x 20



Art. 152304
h. 11 x 20



Art. 152305
h. 11 x 20



Art. 7566

Fino a cm 12 x 10

Art. 756601

Fino a cm 18 x 15

Art. 756602

Fino a cm 24 x 20



Art. 7568

Fino a cm 8 x 15

Art. 756801

Fino a cm 16 x 28

Art. 756802

Fino a cm 20 x 35



Art. 7567

Fino a cm 8 x 15

Art. 756701

Fino a cm 16 x 28

Art. 756702

Fino a cm 20 x 35

Caratteri in rilievo

Tipo "BM"	ABCDEFG	Tipo "BL"	ABCDEF
Tipo "BS"	ABCDEFGH	Tipo "RL"	ABCDEFGH

**Dicitura con lettere in rilievo
compresa nel prezzo**

Free inscription

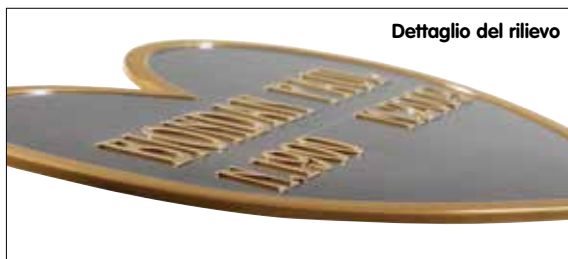

Dettaglio del rilievo

Finitura bianca a pag. 313

Targhe con lettere in rilievo
Esempi con Carattere Tipo "RL"



Art. 152401

h. 14 x 23



Art. 152402

h. 14 x 23



Art. 152403

h. 14 x 23



Art. 152405

h. 14 x 23



Art. 152404

h. 14 x 23

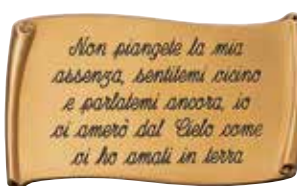

Art. 152802

h. 16 x 27



Art. 152803

h. 16 x 27

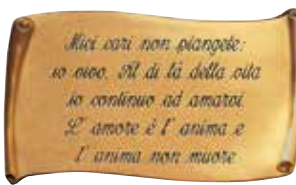

Art. 152801

h. 16 x 27

Vedi accessorio a pag. 17 per rendere adesive le pergamene.

Parchimene a testo fisso



Art. 7557
h. 14 x 18



Art. 7556
Incisione mano compresa nel prezzo
h. 12 x 20



Art. 7559
A richiesta si eseguono altre diciture
h. 8,5 x 8,5



Art. 7439
A richiesta si eseguono altre diciture
h. 11,5 x 20,5



Esempio Art. 7439



Art. 7558
A richiesta si eseguono altre diciture
h. 4 x 26



* Targa fusa con lettere in rilievo

Art. 1462
h. 2,5 x 7 o simili



Targa in ottone con lettere incise

Art. 1658
h. 2,5 x 7 minimo 50 pezzi



Art. 2632
Fino a cm 8 x 15

Art. 2633
Fino a cm 16 x 28

Art. 2727
Fino a cm 25 x 60

Disponibili anche in versione acciaio.

PEZZI	500	1000	1500	2000
SCONTO		-15%	-20%	-25%
PREZZO INTERO				



Art. 27E7 ■■
h. 3,1 x 8,3
Adesiva

Caratteri disponibili per incisione	
TIPO	
"CD"	<i>Abcdef</i>
"BM"	ABCDEFGH
"BL"	ABCDEF
"BS"	ABCDEFGH

INCISIONE
Art. 2520

ESEMPI DI INCISIONI



Per incisioni
su cornici vedi Pag. 28



Incisione gratuita
Free engraving



Art. 734908
8 x 10

Art. 7349
9 x 12

Art. 7350
11 x 15



Art. 7346
9 x 12

Art. 7347
10 x 15



Art. 7355
9 x 12

Art. 7356
11 x 15



Art. 7352
9 x 12

Art. 7353
10 x 15

Serie Rose



Art. 7033
9 x 12

Art. 7034
11 x 15



Art. 7024
9 x 12

Art. 7025
10 x 15



Art. 7062
9 x 12

Art. 7063
11 x 15



Art. 7016
9 x 12

Art. 7017
10 x 15

Serie Cirri



Art. 169608
8 x 10

Art. 1696
9 x 12

Art. 2831
11 x 15



Art. 2733
9 x 12

Art. 2832
10 x 15



Art. 1983
9 x 12

Art. 2835
11 x 15



Art. 2732
9 x 12

Art. 2836
10 x 15

Serie Ulivo

*Serie Rose
patinata antica*



Art. 7349N
9 x 12

Art. 7350N
11 x 15



Art. 7346N
9 x 12

Art. 7347N
10 x 15



Art. 7355N
9 x 12

Art. 7356N
11 x 15



Art. 7352N
9 x 12

Art. 7353N
10 x 15

*Serie Cirri
patinata antica*



Art. 7033N
9 x 12

Art. 7034N
11 x 15



Art. 7024N
9 x 12

Art. 7025N
10 x 15



Art. 7062N
9 x 12

Art. 7063N
11 x 15



Art. 7016N
9 x 12

Art. 7017N
10 x 15

Serie Torciglione



Art. 1116
8 x 10

Art. 1109
9 x 12

Art. 1110
11 x 15

Art. 1596
13 x 18



Art. 2324
8 x 10

Art. 1113
9 x 12

Art. 1117
10 x 15

Art. 1161
11 x 15

Art. 1484
13 x 18

 **-Art. 1485 ■■**
18 x 24



Art. 1426
9 x 12

Art. 1427
11 x 15

Art. 1428
13 x 18



Art. 1814
9 x 12

Art. 1815
10 x 15

Art. 1816
13 x 18

 **-Art. 1817 ■■**
18 x 24



Art. 7111
8 x 10

Art. 7112
9 x 12

Art. 7113
11 x 15



Art. 7115
9 x 12

Art. 7116
10 x 15

Art. 7098
11 x 15

Serie Orum



Art. 1864
5 x 7

Art. 1938
8 x 10

Art. 1947
9 x 12

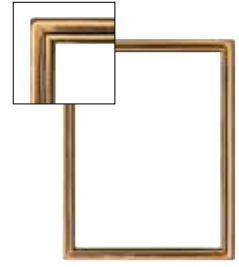

Art. 2088
11 x 15

Art. 2092
13 x 18

Art. 2087
8 x 10

Art. 2090
11 x 15

Art. 2089
9 x 12

Art. 2091
13 x 18

Art. 1948
10 x 15

Serie Universale



Art. 294508
8 x 10

Art. 2945
9 x 12

Art. 2946
11 x 15

Art. 2992
13 x 18



Art. 294907
7 x 9

Art. 2949
9 x 12

Art. 2948
10 x 15

Art. 7055
13 x 18



Art. 2955
9 x 12

Art. 2956
11 x 15

Art. 7080
13 x 18



Art. 2959
9 x 12

Art. 2960
10 x 15

Art. 7081
13 x 18

Serie Alliance Oro



Art. 293808
8 x 10

Art. 2938
9 x 12

Art. 2939
11 x 15



Art. 2938U
9 x 12

Art. 2939U
11 x 15

Serie Luna



Art. 1075
6 x 8

Art. 1076
7 x 9

Art. 1077
8 x 10

Art. 1078
9 x 12

Art. 1079
11 x 15



Art. 1068
6 x 8

Art. 1069
7 x 9

Art. 1070
8 x 10

Art. 1071
9 x 12

Art. 1072
11 x 15

Art. 1073
13 x 18

-Art. 1074 ■■
18 x 24



Serie Edera



Art. 1511 5 x 7
Art. 1451 9 x 12

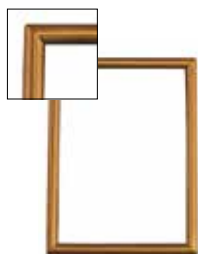

Art. 297407 7 x 9
Art. 2981 10 x 15



Art. 2506 9 x 12



Art. 7207 9 x 12

Art. 1448 6 x 8
Art. 1452 11 x 15

Art. 2974 8 x 10
Art. 298111 11 x 15

Art. 2507 11 x 15

Art. 7208 11 x 15

Art. 1449 7 x 9
Art. 1453 13 x 18

Art. 2980 9 x 12

Art. 1450 8 x 10



Art. 2078 7 x 9
Art. 2077 11 x 15

Art. 2075 8 x 10
Art. 2094 13 x 18

Art. 2076 9 x 12
Art. 2095 18 x 24



Art. 138107 7 x 9

Art. 1381 9 x 12

Art. 1382 10 x 15

Art. 1378 11 x 15

Art. 1377 13 x 18



Art. 1663 9 x 12

Art. 1664 11 x 15

Art. 1945 13 x 18

Art. 1954 18 x 24



Art. 1566 9 x 12

Art. 1567 10 x 15

Art. 1941 13 x 18



Art. 2237 6 x 8
Art. 2405 11 x 15

Art. 2389 8 x 10
Art. 2533 13 x 18

Art. 2404 9 x 12
Art. 2519 18 x 24



Art. 2386 8 x 10

Art. 2408 9 x 12

Art. 2409 10 x 15

Art. 2535 13 x 18



Art. 2477 9 x 12

Art. 2478 11 x 15

Art. 2377 13 x 18



Art. 2475 9 x 12

Art. 2476 10 x 15

Art. 2516 13 x 18



Art. 1052
6 x 8

Art. 1054
8 x 10

Art. 1096
9 x 12

Art. 1067
11 x 15

Art. 1114
13 x 18



Art. 1105
9 x 12

Art. 1106
10 x 15

Art. 1107
13 x 18

Art. 1108
18 x 24

Serie Universale



Art. 2804
9 x 12



-Art. 1992 ■■
9 x 12

-Art. 1996 ■■
10 x 15

Serie Quadrifoglio



Art. 1119
9 x 12

Art. 1120
11 x 15



Art. 1122
9 x 12

Art. 1123
10 x 15



Art. 1128
9 x 12

Art. 1129
11 x 15



Art. 1131
9 x 12

Art. 1132
10 x 15

Serie Kronos



Art. 2337
9 x 12

Art. 2689
11 x 15



Art. 2355
9 x 12

Art. 2688
11 x 15

Serie Barocco



Art. 1156
9 x 12

Art. 1157
11 x 15

Art. 1269
13 x 18



Art. 1347
9 x 12

Art. 1348
11 x 15

Art. 1349
13 x 18

Interno R/86



Art. 2715
9 x 12

Art. 2716
10 x 15

Interno R/86

Serie Iris



■ Art. 2209
9 x 12

Art. 2210
10 x 15

Art. 2063
13 x 18



■ Art. 2255
9 x 12

Art. 2256
10 x 15

Serie Universale



■ Art. 1043 6 x 8

Art. 1081 9 x 12

Art. 1084 13 x 18

Art. 1044 7 x 9

Art. 1082 10 x 13

Art. 1085 18 x 24

Art. 1045 8 x 10

Art. 1083 11 x 15



■ Art. 7078
Ø 5,5

Art. 2383
Ø 7

Art. 2426
Ø 8

■ *Serie Pompei*
fusione in bronzo "alta qualità"



■ -Art. 1190P
9 x 12

-Art. 1191P
11 x 15

-Art. 1192P
13 x 18



■ -Art. 2142P
9 x 12

-Art. 2143P
11 x 15

-Art. 2144P
13 x 18



■ -Art. 2032P
9 x 12

-Art. 2033P
11 x 15

-Art. 2034P
13 x 18



■ -Art. 2035P
9 x 12

-Art. 2036P
11 x 15

-Art. 2037P
13 x 18

■ *Serie Viola e Camelia*
fusione in bronzo "alta qualità"



■ -Art. 1190
9 x 12

-Art. 1191
11 x 15

-Art. 1192
13 x 18



■ -Art. 2142
9 x 12

-Art. 2143
11 x 15

-Art. 2144
13 x 18



■ -Art. 2032
9 x 12

-Art. 2033
11 x 15

-Art. 2034
13 x 18



■ -Art. 2035
9 x 12

-Art. 2036
11 x 15

-Art. 2037
13 x 18

Bronzo "alta qualità"



■ -Art. 2527 ■ ■
11 x 15



■ -Art. 2453 ■ ■
9 x 12

■ -Art. 2454 ■ ■
11 x 15



■ -Art. 1099 ■ ■
9 x 12

■ -Art. 1100 ■ ■
10 x 15

■ -Art. 1101 ■ ■
13 x 18

■ -Art. 1102 ■ ■
18 x 24



■ Art. 2613
11 x 15



■ Art. 2279
11 x 15



■ -Art. 7504
9 x 12

■ -Art. 7505
10 x 15



■ -Art. 7500
9 x 12

■ -Art. 7501
11 x 15



■ -Art. 7506
9 x 12

■ -Art. 7507
10 x 15



■ -Art. 7502
9 x 12

■ -Art. 7503
11 x 15



■ Bronzo "alta qualità"



■ Art. 4276
per foto 2,5 x 3,5



■ Art. 7650/H
per foto 3 x 4



■ Art. 1449/H
per foto 7 x 9

■ Art. 7639/H
per foto 3,5 x 4,5

Cornici adesive



-Art. 2814/S ■■
h. 38 x 28 - esclusa cornice



-Art. 2814/D ■■
h. 38 x 28 - esclusa cornice

(Specificare cornice richiesta, misura massima applicabile: ovale 11 x 15)

Art. 113407/S
h. 7



Art. 113410/S
h. 10

Art. 1134/S
h. 18

Art. 7614/S
h. 20,5



Art. 113407/D
h. 7

Art. 113410/D
h. 10

Art. 1134/D
h. 18

Art. 7614/D
h. 20,5

Supporti orientabili



Art. 2656
(prezzo escluso cornice - specificare codice)
attacco Ø 8 e chiusura retro per cornici:
9x12 / 10x15 / 11x15 ovali e rettangolari

Esempi
con cornice
applicata



Art. 7429
(prezzo escluso cornice - specificare codice)
attacco Ø 4 da 9x12 a 13x18 ovali e rettangolari

Esempi con incisione



Per le incisioni di nome, cognome, data,
Art. 2520



Tipo "CD" *Abcd*
Tipo "BM" ABCDEFG



Tipo "BL" ABCDEF
Tipo "BS" ABCDEFGH



FIORE BRONZATO

Art. 2951X
9 x 12

Art. 2952X
11 x 15



FIORE DORATO

Art. 2951
9 x 12

Art. 2952
11 x 15



FINITURA DORATA

Art. 2075U
8 x 10

Art. 2076U
9 x 12

Art. 2077U
11 x 15

Art. 2094U
13 x 18



Art. 1381U
9 x 12

Art. 1382U
10 x 15

Art. 1377U
13 x 18



Art. 712312
h. 24 x 23 - 9 x 12 F/31

Art. 712310
h. 24 x 25 - 10 x 15 F/31



Art. 7122
h. 24 x 35 x 17 F/31



Art. 712309
h. 24 x 23 - 9 x 12 F/31

Art. 712311
h. 24 x 25 - 11 x 15 F/31

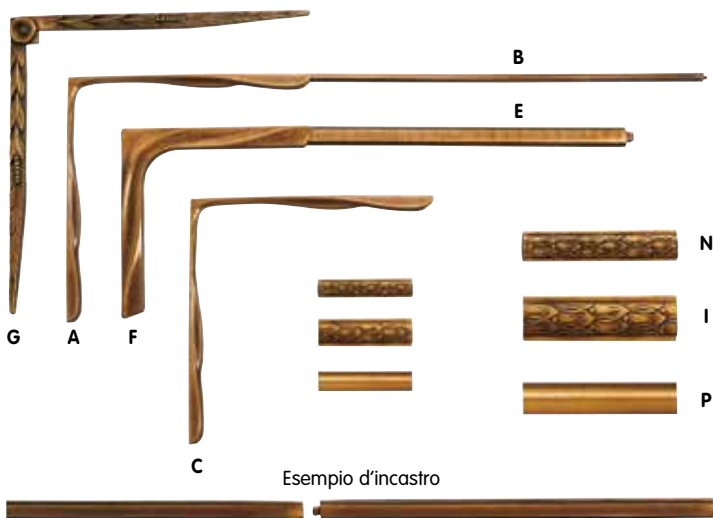

Esempio d'incastro

A Art. 1329
h. 27 x 27

B Art. 2062
h. 1 x 45

C Art. 2349
h. 27 x 27

E Art. 2228
h. 2 x 41

F Art. 2227
h. 21 x 21

G Art. 1493
h. 34 x 34

I Art. 1309
h. 3 (prezzo al cm.)

N Art. 1308
h. 2 (prezzo al cm.)

P Art. 1258
h. 2 (prezzo al cm.)

N.B. Le nostre bordure Art. 2062 e Art. 2228 sono regolabili per mezzo del loro particolare sistema d'incastro. Unendo più bordure, si possono ottenere varie misure.



 **-Art. 1652** ■ ■
Ø 15,5



Art. 1547
Ø 11



Art. 1655
Ø 7

Art. 1654
Ø 8,5

Art. 1656
Ø 10



Art. 1657
Ø 8



Art. 1706
Ø 6,5 -



Art. 1683
Ø 8

Art. 1684
Ø 11

Portante con
sistema antiscasso
Theft-proof



Art. 2366
Ø 8

Art. 2350
Ø 11

Portante con
sistema antiscasso
Theft-proof



Art. 1866
h. 17 x 16



Art. 2315
h. 13 x 14



Art. 2739
h. 13 x 14



Art. 1675
h. 9,5 x 9,5



Art. 1169
Ø 3



Art. 1220
Ø 2



Art. 1159
h. 2,5



***Art. 1149**
h. 5



***Art. 7032**
Ø 6
Perno 8 MA V/18

Art. 1170
Ø 4

Art. 1229
Ø 2,5

Art. 1146
h. 3

Art. 1150
h. 6

***Art. 1244**
Ø 6
Perno 8 MA V/18

Art. 1171
Ø 5

Art. 1369
Ø 3,5

Art. 1147
h. 3,5

***Art. 1160**
h. 8

Art. 1172
Ø 6

***Art. 1370**
Ø 5

Art. 1148
h. 4

***Art. 7008**
Ø 5,5



Art. 1140
h. 3



Art. 1257
h. 4 x 4



Art. 2306
Ø 3



Art. 1281
h. 5



Art. 1138
h. 4

Art. 1141
h. 3,5

Art. 2307
Ø 4

***Art. 1279**
h. 10
perno 6 MA V/10

Art. 1139
h. 5

Art. 1142
h. 4

Art. 2308
Ø 5

Art. 1198
h. 6

Art. 1143
h. 5

Art. 2309
Ø 6

Art. 1417
h. 6

Con foro passante
escluso vite



***Art. 1254**
Ø 4,5



***Art. 1167**
Ø 5



Art. 1137
h. 5



Art. 1162
h. 3



Art. 1173
h. 4



***Art. 1465**
Ø 4,3

***Art. 1168**
Ø 7

Art. 2918
h. 5
Con foro passante
escluso vite

Art. 1163
h. 3,5

Art. 1174
h. 5

Art. 1145
Ø 3,5
Con foro passante
escluso vite

Art. 1164
h. 4

Art. 1165
h. 4,5

Art. 1166
h. 5

Art. 1158
Ø 5
Con foro passante
escluso vite

Le borchie vengono fornite con perno V/01 da mm. 50 passo 5 MA, salvo diversa descrizione.
In caso di sostituzione del perno, quello in dotazione verrà valutato al prezzo di listino.

* A richiesta possono essere fornite con perno fino a 10 MA.

CHIAVARDE PORTANTI comprensive di perno acciaio inox 8 MA V/94



Art. 1245

6 x 6 - (spessore marmo mm.20)

Art. 2658

6 x 6 - (spessore marmo mm.20)

CHIAVARDA PORTANTE



Art. 128808 - 4,5 x 2,5
Spessore mm. 20
con perno 8 MA x 100 inox

POMELLO PER SIGILLI



Art. 1317 - Ø 2,5
Con perno 8 MA x 70



Art. 1318 - Ø 2,5 x 4
Con perno 10 MA x 40



Art. 1522 - Ø 5
Con perno 6 MA x 140



Art. 174608
Ø 8 - con perno 8 MA x 100 inox



Art. 1206
Ø 5 - con perno 8 MA x 100 inox

Perni inox inclusi nel prezzo

SISTEMA DI SOLLEVAMENTO

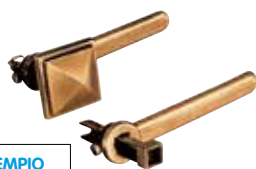

ESEMPIO
con borchia
Art. 1148

CHIAVISTELLO REGOLABILE
Per spessore da mm 5 a 40

Art. 1766

Braccio cm 9

Le borchie (esclusi gli Art. 1160-1167-1168-1169-1170-1171-1172-1220-1229-1239-1244-1254-1279-1369-1370 e 1465) sono adattabili al chiavevstello 1766.

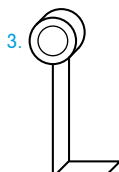

3. INSERIRE
UTENSILE PER
SOLLEVAMENTO

1. SOLLEVARE
L'ANELLO IN
BRONZO

2. REGOLARE
ANELLO
D'ACCIAIO
E DI PORTATA

ANELLONE ALZA SIGILLI

Art. 7121

Ø 11 - portata max Kg. 600
Con perno acciaio inox 14 MA x 190



Art. 1674
9,5 x 9,5
Per spessore
da mm. 18 a 35



Art. 1653
Ø 7

Art. 1659
Ø 8,5
Per spessore
da mm. 18 a 35

CHIAVARDE PORTANTI per spessore marmo da 20 a 30 mm complete di perno inox



+ **Art. 707508**
Ø 6



+ **Art. 2944**
Ø 6,5



+ **Art. 7157**
Ø 4



+ **Art. 7154**
Ø 4



+ **Art. 717508**
Ø 5,5



* **Art. 707512**
Ø 6

* **Art. 294412**
Ø 6,5

+ **Art. 7158**
Ø 5

* **Art. 7175**
Ø 5,5

+ **Art. 7153**
Ø 5,5

* **Art. 715312**
Ø 5,5

* Perno 12 MA inox

+ Perno 8 MA inox



CHIAVARDE PORTANTI per spessore marmo da mm 9 a mm 22



Esempio con perno acciaio inox 8 MA (V/94)



Esempio con perno acciaio inox 8x100

Le misure sono espresse in mm.

PER L'UTILIZZO DEL PERNO V/94 ORDINARE LE CHIAVARDE FILETTATE DA 10MA

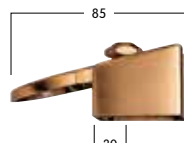
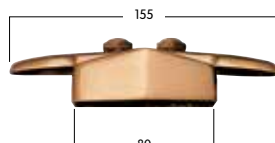
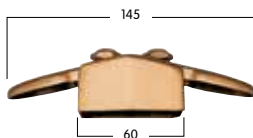

Con perno 8MA inox V/81 **incluso nel prezzo**

Art. 716308

Art. 716408

Art. 716508

Predisposte per perni 10MA ottone **escluso dal prezzo**

Art. 7163

Art. 7164

Art. 7165

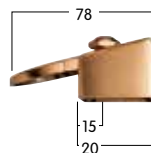
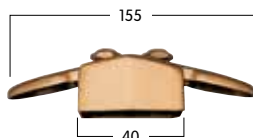

Con perno 8MA inox V/81 **incluso nel prezzo**

Art. 738308

Art. 739008

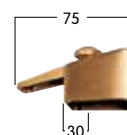
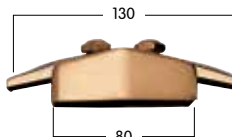
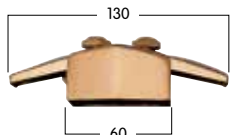

Con perno 8MA inox V/81 **incluso nel prezzo**

Art. 145708

Art. 715908

Art. 716008

Predisposte per perni 10MA ottone **escluso dal prezzo**

Art. 1457

Art. 7159

Art. 7160

CHIAVARDE PORTANTI

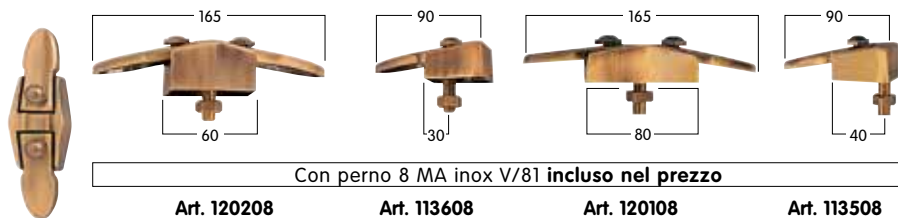

Con perno 8 MA inox V/81 **incluso nel prezzo**

Art. 120208 Art. 113608 Art. 120108 Art. 113508

Predisposte per perno 10 MA ottone **escluso dal prezzo**

Art. 1202 Art. 1136 Art. 1201 Art. 1135

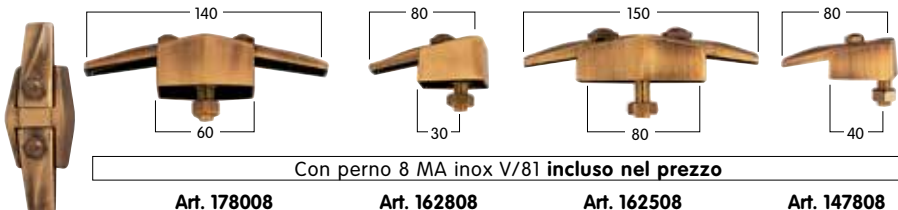

Con perno 8 MA inox V/81 **incluso nel prezzo**

Art. 178008 Art. 162808 Art. 162508 Art. 147808

Predisposte per perno 10 MA ottone **escluso dal prezzo**

Art. 1780 Art. 1628 Art. 1625 Art. 1478

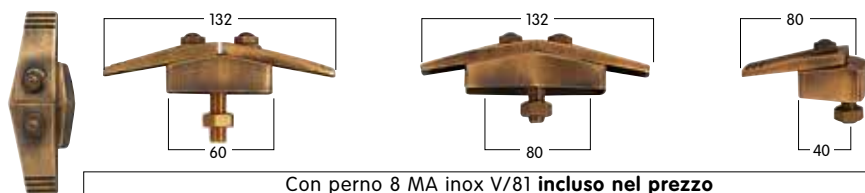

Con perno 8 MA inox V/81 **incluso nel prezzo**

Per marmo da 9 a 22 **Art. 123008 Art. 123108 Art. 123208**

Per marmo da 19 a 32 **Art. 265508 Art. 264308 Art. 253108**

Predisposte per perno 10 MA ottone **escluso dal prezzo**

Per marmo da 9 a 22 **Art. 1230 Art. 1231 Art. 1232**

Per marmo da 19 a 32 **Art. 2655 Art. 2643 Art. 2531**

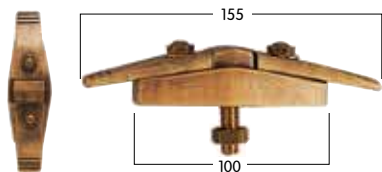

Perno 8 MA inox V/81 **incluso nel prezzo**

Per marmo da 9 a 22 **Art. 246308**

Predisposte per perno 10 MA **escluso dal prezzo**

Art. 2463

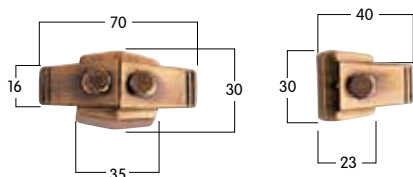

Perno 6 MA inox V/83 **incluso nel prezzo**

Per marmo da 7 a 20 **Art. 2431 Art. 2432**

Per marmo da 19 a 32 **Art. 2030 Art. 2031**

CHIAVARDE PORTANTI per spessore marmo variabile - con perno 8 MA inox V/91 **incluso nel prezzo**

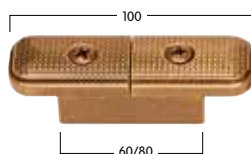

Art. 7241 - mm. 60
Per spessore da mm. 27 a 32

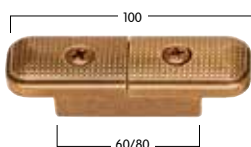

Art. 7239 - mm. 60
Per spessore da mm. 17 a 22

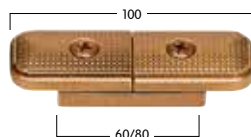

Art. 7237 - mm. 60
Per spessore da mm. 10 a 15

Art. 7235 - mm. 80
Per spessore da mm. 27 a 32

Art. 7233 - mm. 80
Per spessore da mm. 17 a 22

Art. 7231 - mm. 80
Per spessore da mm. 10 a 15

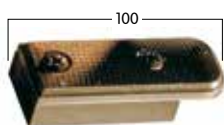

Art. 7236 - mm. 60
Per spessore da mm. 10 a 15

Art. 7238 - mm. 60
Per spessore da mm. 17 a 22



Esempio
esempio con perno acciaio
inox 8 MA x 100 **incluso nel prezzo**

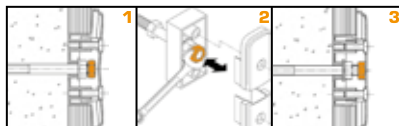

SISTEMA DI REGOLAZIONE

Art. 7240 - mm. 60
Per spessore da mm. 27 a 32

Art. 7230 - mm. 80
Per spessore da mm. 10 a 15

Art. 7232 - mm. 80
Per spessore da mm. 17 a 22

Art. 7234 - mm. 80
Per spessore da mm. 27 a 32

CHIAVARDE PORTANTI per spessore marmo da mm 18 a mm 22 - con perno 8 MA inox V/91F **incluso nel prezzo**



Art. 2910 - mm. 60
Art. 2908 - mm. 80



Art. 2914 - mm. 60

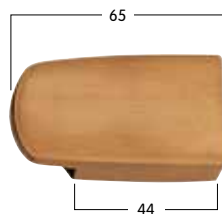
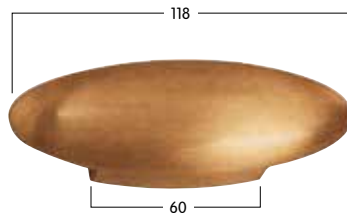
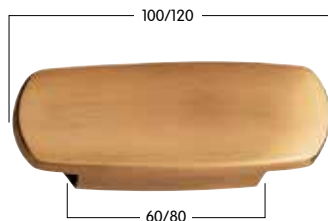

Art. 2911

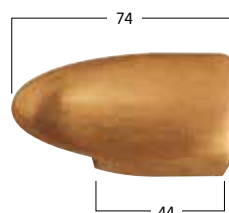

Art. 2915



CHIAVARDE PORTANTI per spessore marmo costante

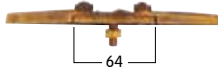

Art. 1366

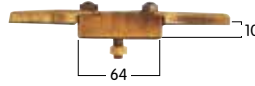

Art. 1367

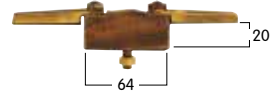

Art. 1368

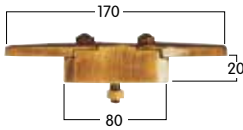

Art. 1375

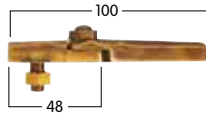

Art. 1289

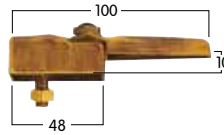

Art. 1290

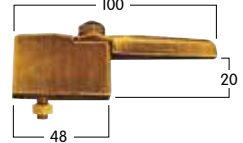

Art. 1302

Con perno 8 MA x 100 in acciaio inox V/81 incluso nel prezzo.

LANCE SCIOLTE



Art. 2466



Art. 2467

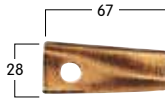

Art. 1673

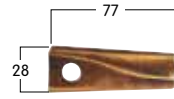

Art. 1676

Perni in acciaio inox (passo MA)



V/91F
100 x 8



V/92
100 x 8



V/91
100 x 8



V/85
50 x 5



V/83
70 x 6



V/81
100 x 8

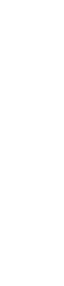

V/86
100 x 10



V/94
100 x 8



V/97
30 x 8

V/07
50 x 6

V/82
100 x 6

V/78
120 x 8

V/79
100 x 12

V/98 new
30 x 5

V/84
60 x 6

V/80
80 x 8

V/87
120 x 12

V/88
140 x 12

CHIAVARDE PORTANTI per spessore marmo variabile da 9 a 22 mm.

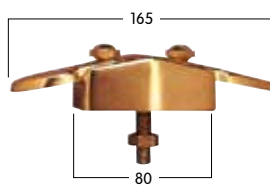
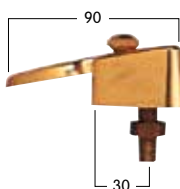
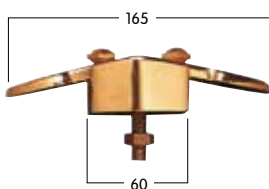

Chiavarde con perno 8 MA x 100 inox V/81 **incluso nel prezzo**

Art. 120208U

Art. 113608U

Art. 120108U

Chiavarde predisposte per perno 10 MA x 100 ottone **escluso dal prezzo**

Art. 1202U

Art. 1136U

Art. 1201U

CHIAVARDE PORTANTI per spessore marmo da mm 18 a mm 22



Art. 1229U

Ø 2,5

Art. 1369U

Ø 3,5

Art. 1370U

Ø 5

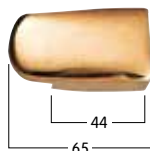

Art. 2911U

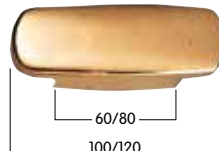

Art. 2910U

mm. 60

Art. 2908U

mm. 80

Con perno 8MA inox V/91F **incluso nel prezzo**

Perni in ottone (passo MA)



V/51
60 x 5

V/55
80 x 6

V/59
120 x 8



V/42
50 x 5



V/47
60



V/35
40 x 3

V/03
70 x 5

V/10
50 x 6

V/18
60 x 8

V/22
120 x 8

V/32
80 x 12

V/52
70 x 5

V/56
100 x 6

V/60
80 x 10

V/43
70 x 5

V/48
70

V/38
40 x 4

V/04
80 x 5

V/11
60 x 6

V/19
70 x 8

V/26
80 x 10

V/33
100 x 12

V/53
100 x 5

V/57
80 x 8

V/61
100 x 10

V/44
50 x 6

V/49
80

V/01
50 x 5

V/05
100 x 5

V/12
70 x 6

V/20
80 x 8

V/27
100 x 10

V/34
120 x 12

V/54
70 x 6

V/58
100 x 8

V/45
70 x 6

V/02
60 x 5

V/06
120 x 5

V/13
100 x 6

V/21
100 x 8

V/28
120 x 10



Art. 2263/S
h. 50 x 57 x 15 R/73 F/02

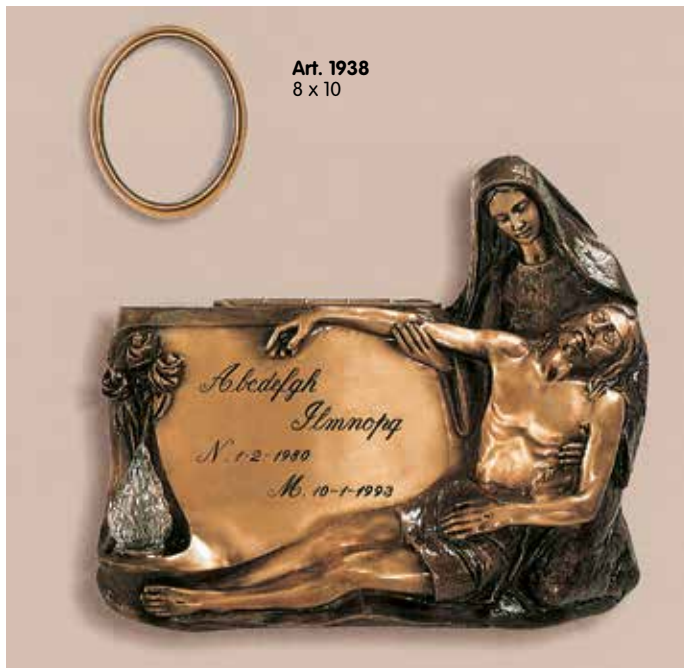

Art. 1938
8 x 10

Art. 2263/D
h. 50 x 57 x 15 R/73 F/02



■ ■ Art. 3438
h. 36 x 35 x 19 R/39T



■ -Art. 2527 ■ ■
11 x 15



■ ■ Art. 7135 R
h. 48 x 55 x 12 R/07 F/02



Art. 1947
9 x 12

Art. 2088
11 x 15

Art. 2092
13 x 18



Art. 1920 R
h. 32 x 35 R/07



Art. 1924
h. 36 x 15 x 10



Art. 1923
h. 21 x 14 F/02



Art. 1914 R
h. 32 x 35 R/07



Art. 1925
11 x 15



Art. 1959
h. 27 x 23 x 10 M/41-A





Art. 2529 R
h. 20 x 36 x 13 R/07



Art. 2700
h. 24 x 16 x 8 F/02



Art. 2699
h. 23 x 18 x 11 M/41-A



 **-Art. 2527 ■■**
11 x 15



Art. 2525
h. 24 x 11 x 6



Art. 2528/S
h. 25 x 15



Art. 2528/D
h. 24 x 15



■ ■ Art. 2527 ■ ■
11 x 15

■ ■ Art. 7133 R ■ ■
h. 54 x 56 x 15 R/07 F/02



Art. 1947
9 x 12

Art. 2088
11 x 15

Art. 2092
13 x 18



Art. 1965
h. 40 x 15

■ ■ Art. 7134 ■ ■
h. 26 x 36 x 12 I/15 F/01





Art. 2235
h. 31 x 20 F/02



Art. 2276 R
h. 26 x 36 x 12 R/07



Art. 2277
h. 23 x 22 x 12 M/41-A



Art. 2279
11 x 15



Art. 2278
h. 56 x 22





Art. 2635 R
h. 40 x 58 x 16 R/51 F/02



Art. 2619 R
h. 55 x 56 x 12 R/14 F/02



Art. 2279
11 x 15



Art. 2299
h. 24 x 19 x 11
M/41-A



Art. 2281
h. 20 x 10 x 4



Art. 2221
h. 27 x 14 x 10
F/02



Art. 2250 R
h. 43 x 57 x 13 R/07



Art. 2613
11 x 15



Art. 2614 R
h. 21 x 41 x 9 R/17



Art. 2616
h. 22 x 19 x 7
F/02



Art. 2615
h. 28 x 17,5 x 8
M/29



Art. 1459 R
h. 28 x 60 x 13 R/70**



Esempio di composizione
(lampada posizionabile
anche a sinistra)



Art. 1411 R
h. 28 x 60 x 13 F/03 R/70**
Composizione realizzabile in fase di montaggio



Esempio di composizione



Esempio di composizione



■ ■ **Art. 2345 P**
h. 40 x 59 x 12 F/03 P/77**
Composizione realizzabile in fase di montaggio



-Art. 2453
9 x 12

-Art. 2454
11 x 15



-Art. 2590 R
h. 21 x 19 x 10 R/71-C



-Art. 2586 R
h. 20 x 35 x 11 R/07



-Art. 2592
h. 23 x 12 x 8 F/02



-Art. 1099
9 x 12

-Art. 1100
10 x 15

-Art. 1101
13 x 18

-Art. 1102
18 x 24



-Art. 2591
h. 21 x 16 x 10 M/41-A



-Art. 2593
h. 25 x 15,5

■ Serie Scirocco - fusione in bronzo "alta qualità"



 -Art. 27F9 ■■
h. 20 x 10 x 12 F/02



 -Art. 1088 R ■■
h. 40 x 50 x 10 R/32



Art. 1089
9 x 12



Art. 1093 R ■■
h. 25 x 42 x 13 R/13



Art. 294508
8 x 10

Art. 2945
9 x 12

Art. 2946
11 x 15

Art. 2992
13 x 18



Art. 27F8 ■■
h. 31 x 18 x 11 F/02



Art. 1066
h. 10,5 x 7



Art. 2482
Placca h. 35 x 35
con cornice orientabile Art. 2088
11 x 15



-Art. 2481 P ■■
h. 22 x 56 x 11 P/77** F/02

Art. 2352
Placca h. 35 x 35
con cornice orientabile Art. 2088
11 x 15



-Art. 2351 P ■■
h. 22 x 56 x 11 P/77** F/02



-Art. 2720/S
h. 59 x 67 x 10 P/77** F/02

Escluso cornice



-Art. 2720/D
h. 59 x 67 x 10 P/77** F/02

Escluso cornice

Specificare la cornice 11x15 richiesta



Esempio L/07
 h. 41 x 56 x 13,5



-Art. 2510/S
 h. 41 x 50
 con cornice orientabile Art. 2088
 11 x 15



-Art. 2510/D
 h. 41 x 50
 con cornice orientabile Art. 2088
 11 x 15

Monoplaacca universale
 per l'applicazione di vasi e
 lampade a scelta



-Art. 2526 R
h. 40 x 55 x 11 R/13 F/02 B/04
con cornice orientabile 11 x 15



Esempio L/04
h. 34 x 55 x 12



-Art. 2511
h. 20 x 50

Monoplacca universale
per l'applicazione di vasi e
lampade a scelta



-Art. 2721 P ■■
h. 62 x 63 P/77** F/02 con cornice 11 x 15



-Art. 1992 ■■ - 9 x 12
-Art. 1996 ■■ - 10 x 15

-Art. 1997 P ■■
h. 34 x 39 P/70** F/02



Art. 2507
11 x 15

-Art. 2657 R ■■
h. 20 x 62 x 10 R/13 F/02



Art. 2088
11 x 15

-Art. 2484 P ■■
h. 23 x 56 x 11 P/77** BG/1



-Art. 1873 R ■■
h. 36 x 56 F/02 R/A3 con cornice 9 x 12



-Art. 1906 R ■■
h. 36 x 56 F/02 R/A3 con cornice 9 x 12



 -Art. 1987 R ■■
h. 37 x 58 F/02 R/77**



 -Art. 2620 R ■■
h. 46 x 61 x 10 R/13 F/02
con cornice 11 x 15



Art. 2804
9 x 12

Art. 1986/S
h. 23 x 58 x 10 R/54 F/02



Art. 2804
9 x 12

Art. 1986/D
h. 23 x 58 x 10 R/54 F/02



Art. 7430 P
h. 36 x 54 x 9,5
P/17D F/12
con cornice 9 x 12 art. 1451

Art. 743001 P
h. 27 x 35 x 7
P/75 F/01
con cornice 7 x 9 art. 1449



Art. 7428 P
h. 38 x 46 x 16
P/60BR F/12
con cornice 9 x 12 art. 2076

Art. 742801 P
h. 27 x 35 x 12
P/50 F/01
con cornice 7 x 9 art. 2078



Art. 7427 P
h. 38 x 54 x 17
P/60BR F/12
con cornice 9 x 12 art. 2076

Art. 742701 P
h. 26 x 35 x 10
P/50 F/01
con cornice 7 x 9 art. 2078



Art. 7410 P
h. 20,5 x 13 x 14 P/83

Art. 7543 P
h. 20,5 x 13 P/83

Art. 7409 P
h. 30,5 x 18 P/2901



Art. 7417
h. 20,5 x 9,5 x 10 F/12

Art. 7488
h. 20,5 x 9,5 x 10 F/12



Art. 7408 P
h. 19 x 20 x 15 P/A14**

Art. 7483 P
h. 19 x 20 P/A14**



Art. 2078 **Art. 2077**
7 x 9 11 x 15

Art. 2075 **Art. 2094**
8 x 10 13 x 18

Art. 2076 **Art. 2095**
9 x 12 18 x 24



Art. 138107
7 x 9

Art. 1381
9 x 12

Art. 1382
10 x 15

Art. 1378
11 x 15

Art. 1377
13 x 18



Art. 7337 P
h. 20 x 11 x 11,5 P/83

Art. 7344 P
h. 20 x 11 P/83

Art. 734430 P
h. 30 x 16 P/2901



Art. 7339
h. 19 x 10 x 10,5 F/12

Art. 733923
h. 23 x 10,5 F/03

Art. 7345
h. 19 x 10 F/12

Art. 734523
h. 23 x 10,5 F/03



Art. 7336 P
h. 18,5 x 16 x 12,5 P/A10

Art. 7348 P
h. 18,5 x 16 P/A10

Ossari

Art. 733713 P
h. 13,5 x 7 x 7,5 P/50

Art. 734413 P
h. 13,5 x 7 P/50

Ossari

Art. 733914
h. 14 x 8 x 8,5 F/01

Art. 734514
h. 14 x 8 F/01



Art. 4079IP
h. 20 x Ø 31 P/41



Art. 7033 Art. 7034
9 x 12 11 x 15



Art. 7024 Art. 7025
9 x 12 10 x 15



Art. 753916 P
h. 16 x 9
P/65**

Art. 7544 P
h. 20 x 11
P/92-A

Art. 7539 P
h. 20 x 11 x 11,5
P/92-A

Art. 753930 P
h. 29 x 16
P/29-A



Art. 7540
h. 19 x 9 x 9,5 F/02

Art. 754023
h. 23 x 9,5 F/03

Art. 7545
h. 19 x 9 F/02

Art. 7541
h. 23 x 10 F/03



Art. 7538 P
h. 18,5 x 16 x 12,5
P/A10

Art. 7548 P
h. 18,5 x 16
P/A10

Ossari

Art. 753913 P
h. 12 x 6,5 x 7
P/A11

Art. 754413 P
h. 12 x 6,5
P/A11

Art. 753908 P
h. 8 x 4,2 x 4,5
P/39

Ossari

Art. 754014
h. 14 x 7 x 7,5
F/01

Art. 754514
h. 14 x 7
F/01



Art. 1511
5 x 7

Art. 1451
9 x 12

Art. 1448
6 x 8

Art. 1452
11 x 15

Art. 1449
7 x 9

Art. 1453
13 x 18

Art. 1450
8 x 10

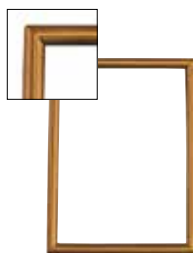

Art. 297407
7 x 9

Art. 2981
10 x 15

Art. 2974
8 x 10

Art. 298111
11 x 15

Art. 2980
9 x 12

Serie Dune



Art. 7301 P
h. 20 x 9,5 P/17D

Art. 7363 P
h. 20 x 9,5 P/17D



Art. 7351
h. 20 x 8 F/12

Art. 7364
h. 20 x 7 F/12



Art. 7401 P
h.17,5 x 12 P/70**

Art. 7365 P
h. 17,5 x 11 P/70**

Ossari

Art. 730114 P Art. 736314 P
h.14 x 7 P/75 h.14 x 7 P/75

Ossari

Art. 735114 Art. 736414
h.14 x 6,5 F/01 h.14 x 6,5 F/01

Serie Solaris



Art. 7552 P Art. 7550 P
h. 20 x 12 P/60BR h. 20 x 11 P/60BR

Art. 755029 P
h. 29 P/2901



Art. 7553 Art. 7551
h. 20 x 9 F/12 h. 20 x 8 F/12

Art. 755126
h. 27 x 11,5 F/03



Art. 7555 P
h.17 x 12 P/A3

Art. 7554 P
h. 17 x 11 P/A3

Ossari

Art. 755214 P Art. 755014 P
h.14 x 7 P/50 h.14 x 6,5 P/50

Ossari

Art. 755314 Art. 755114
h.14 x 6,5 F/01 h.14 x 5,5 F/01



Art. 7302 R
h. 20,5 x 12 R/93-A

Art. 7302 P
h. 20,5 x 12 P/83

Art. 7308 R
h. 20,5 x 12 R/93-A

Art. 7308 P
h. 20,5 x 12 P/83

Art. 7303 R
h. 29 x 15,5 R/88-D

Art. 7303 P
h. 29 x 15,5 P/68



Art. 7304
h. 20 x 10 F/12

Art. 7309
h. 20 x 10 F/12

Art. 7323
h. 25 x 11 F/03



Art. 7305 P
h. 19 x 16 x 11 P/70**

Art. 7310 P
h. 19 x 16 x 11 P/70**



Art. 7102 P
h. 20 x 12 P/92-A

Art. 7105 P
h. 20 x 12 P/92-A

Art. 7102 R
h. 20 x 12 R/97

Art. 7105 R
h. 20 x 12 R/97



Art. 7101
h. 20 x 10 F/12

Art. 7104
h. 20 x 9,5 F/12



Art. 7100 P
h. 19 x 17 x 12 P/A3

Art. 7103 P
h. 19 x 17 P/A3



Art. 2982UR
h. 21 x 13 x 11 R/93

Art. 2969UR
h. 21 x 13 R/93

Art. 2996UR
h. 29 x 17 R/88-D



Art. 2983U
h. 20 x 10 x 11 F/02

Art. 2970U
h. 20 x 10 F/02

Art. 2997U
h. 25 x 12 F/03



Art. 2984U
h. 23 x 14 x 14 M/41-8

Art. 2971U
h. 23 x 14 M/41-8

Art. 29Y9U
h. 26 x 17 M/57



Art. 2985UR
h. 18 x 20 x 15 R/77**

Art. 2958UR
h. 18 x 20 R/77**

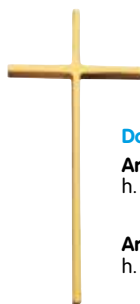

Dorata

Art. 1763U
h. 20 x 9

Art. 1764U
h. 25 x 9



Art. 294508 **Art. 2946**
8 x 10 11 x 15

Art. 2945 **Art. 2992**
9 x 12 13 x 18



Art. 2955 **Art. 7080**
9 x 12 13 x 18

Art. 2956
11 x 15



Art. 294907 **Art. 2948**
7 x 9 10 x 15

Art. 2949 **Art. 7055**
9 x 12 13 x 18



Art. 2959 **Art. 7081**
9 x 12 13 x 18

Art. 2960
10 x 15



Art. 7106 R
h. 20 x 12 R/97

Art. 7108 R
h. 30 x 18 R/B3

Art. 7106 P
h. 20 x 12 P/92-A

Art. 7108 P
h. 30 x 18 P/29**

Art. 7107 R
h. 20 x 12 R/97

Art. 7107 P
h. 20 x 12 P/92-A

Ossari

Art. 7431 P
h. 12 x 6 x 6,5
P/43**

Art. 7432 P
h. 12 x 6
P/43**



Art. 7109
h. 20 x 10 F/12

Art. 7110
h. 20 x 10 F/12

Ossari

Art. 7433
h. 14 x 6 x 7 F/01

Art. 7434
h. 14 x 6 F/01



Art. 7119 R
h. 18 x 18 x 13 R/A3

Art. 7119 P
h. 18 x 18 x 13 P/A3

Art. 7120 R
h. 18 x 18 x 13 R/A3

Art. 7120 P
h. 18 x 18 x 13 P/A3



Art. 7117
h. 23 x 14 M/41-8

Art. 7118
h. 23 x 14 M/41-8



Art. 7115
9 x 12

Art. 7116
10 x 15

Art. 7098
11 x 15



Art. 7111
8 x 10

Art. 7112
9 x 12

Art. 7113
11 x 15



Art. 7327 P
h. 20,5 x 12 x 12,5
P/83

Art. 7330 P
h. 20,5 x 12
P/83



Art. 7326 P
h. 19 x 16 x 11,5
P/70**

Art. 7329 P
h. 19 x 16 x 11
P/70**



Art. 7324 P
h. 17 x 27 x 11
P/A74
(sezione ☺)



Art. 7328
h. 20 x 10 x 10,5
F/12

Art. 7331
h. 20 x 10 F/12



Art. 2985 P
h. 18 x 20 x 15
P/70**

Art. 2958 P
h. 18 x 20
P/70**



Art. 2982 P
h. 21 x 13 x 11
P/72

Art. 2982 R
h. 21 x 13 x 11
R/93



Art. 2969 P
h. 21 x 13 P/72

Art. 2969 R
h. 21 x 13 R/93

Art. 2990 P
h. 29 x 15 P/59-D

Art. 2983
h. 20 x 11 F/02

Art. 2998
h. 20 x 10 F/02

Art. 2907
h. 25 x 12 F/03



Art. 2984
h. 23 x 14 x 14 M/41-8

Art. 2971
h. 23 x 14 M/41-8

Art. 29Y9
h. 26 x 17 M/57

Ossari

Art. 7087 P
h. 14 x 9 x 9
P/50

Art. 7089 P
h. 14 x 9
P/50

Ossari

Art. 7086
h. 15 x 8 F/01

Art. 7088
h. 15 x 8 F/01



Art. 1412 P
h. 16 x 8 x 9
P/65**

Art. 2136 R
h. 20,5 x 9,5 x 10
R/60

Art. 2136 P
h. 20,5 x 9,5 x 10
P/92**

Art. 2706 P
h. 29 x 13,5 x 15
P/53-A

Art. 2138 P
h. 20,5 x Ø 10
P/92**

Art. 2138 R
h. 20,5 x Ø 10
R/60

Art. 2500 P
h. 29 x Ø 13,5
P/53-A

-Art. 2588 R ■ ■ ■ 
h. 49 x Ø 23
R/08

Ossari

Art. 4146 P
h. 8,5 x 6 x 5
P/39

Art. 2638 P
h. 11,5 x 6 x 5
P/43**

Art. 2697 P
h. 11,5 x Ø 6
P/43**

Art. 2137
h. 17 x Ø 9,5
F/02

Art. 2707
h. 23 x Ø 11
F/03

Art. 2641
h. 13,5 x Ø 6
F/01

Art. 2139
h. 17 x Ø 9,5
F/02

Art. 2515
h. 23 x Ø 11
F/03

Art. 2698
h. 13,5 x Ø 6
F/01

Ossari

Art. 2492
h. 21 x 12 x 13 B/13

Art. 2491
h. 21 x 12 B/13

Art. 2514
h. 28 x 13,5 BG/1



Art. 1412HALF P2
h. 16 x 7,8 x 5,2
P/6501A
(sezione )



Art. 2387 R
h. 8 x Ø 9,5
R/02

Art. 2388 R
h. 10 x Ø 11
R/03



Art. 2498 P
h. 19,5 x 14 x 12
P/70-A

Art. 2499 P
h. 19,5 x 14
P/70-A



Art. 2237
6 x 8

Art. 2405
11 x 15

Art. 2389
8 x 10

Art. 2533
13 x 18

Art. 2404
9 x 12

Art. 2519
18 x 24



Art. 2386
8 x 10

Art. 2408
9 x 12

Art. 2409
10 x 15

Art. 2535
13 x 18



Art. 2477
9 x 12

Art. 2478
11 x 15

Art. 2377
13 x 18



Art. 2475
9 x 12

Art. 2476
10 x 15

Art. 2516
13 x 18



■ Art. 2932UR
h. 21 x 13 x 11
R/93

■ Art. 2927UR
h. 21 x 13 R/93

■ Art. 2928UR
h. 29 x 17 R/88-D



■ Art. 2933U
h. 20 x 10 x 11 F/02

■ Art. 2929U
h. 20 x 10 F/02



■ Art. 2931U
h. 23 x 14 x 14
M/41-8

■ Art. 2925U
h. 23 x 14
M/41-8

■ Art. 2926U
h. 26 x 17 M/57



■ Art. 2935UR
h. 18 x 30 x 17 R/73

■ Art. 2934UR
h. 18 x 30 R/73



■ Art. 2937UR
h. 18 x 20 x 15 R/77**

■ Art. 2936UR
h. 18 x 20 R/77**



■ Art. 2938U
9 x 12

■ Art. 2939U
11 x 15



■ Art. 2942
h. 24 x 14



Dorata
■ Art. 2942U
h. 24 x 14



■ Art. 294201U
h. 24 x 14



Art. 2932 P
h. 21 x 13 x 11
P/72

Art. 2932 R
h. 21 x 13 x 11
R/93



Art. 2927 R
h. 21 x 13 R/93

Art. 2928 P
h. 29 x 17 P/59-D

Art. 2928 R
h. 29 x 17 R/88-D



Art. 2931
h. 23 x 14 x 14 M/41-8

Art. 2925
h. 23 x 14 M/41-8

Art. 2926
h. 26 x 17 M/57



Art. 2935 P
h. 18 x 30 x 17 P/A73

Art. 2934 P
h. 18 x 30 P/A73



Art. 2933
h. 20 x 10 x 11
F/02

Art. 2929
h. 20 x 10 F/02

Art. 2930
h. 25 x 12 F/03



Art. 293808
8 x 10

Art. 2938
9 x 12

Art. 2939
11 x 15



Art. 1698 P
h. 21,5 x 15 x 13 P/83

Art. 1698 R
h. 21,5 x 15 x 13 R/93

Art. 1984 R
h. 21,5 x 15 R/93

Art. 1693 R
h. 30 x 18 R/88**

Art. 1693 P
h. 30 x 18 P/88**



Art. 1942 R
h. 18 x 21 x 14 R/70**

Art. 1942 P
h. 18 x 21 x 14 P/70**

Art. 1919 R
h. 18 x 21 x 14 R/70**

Art. 1919 P
h. 18 x 21 x 14 P/70**



Art. 1715
h. 20 x 14 x 12 M/58-L

Art. 1979
h. 20 x 14 M/58-L

Art. 1476
h. 26 x 16 M/59



Art. 1697
h. 20 x 10,5 x 9 F/02

Art. 1754
h. 20 x 10,5 F/02

Art. 1694
h. 25 x 13 F/03



Art. 2594 P
h. 16,5 x 24 x 10 P/37**
(sezione ☺)



Art. 2358 h. 17 x 8,5 x 9,5 B/13
Art. 2357 h. 17 x 8,5 B/13



Art. 2545 R h. 19 x 10 R/61
Art. 2547 R h. 19 x 10 R/61
Art. 2571 R h. 29 x 12,5 R/30

Ossari

Art. 2670 R h. 13 x 6 R/53
Art. 2672 P h. 13 x 6 P/35

Art. 2670 P
h. 13 x 6 P/35



Art. 1236 P
h. 16,5 x 24 x 20 P/37**



Art. 2546 h. 18 x 9 F/02
Art. 2548 h. 18 x 9 F/02



Art. 2660 R
h. 8 x 11 x 12 R/03

Art. 2595
h. 23 x 10 F/03

Art. 2419 R
h. 11,5 x 12 R/38

Ossari

Art. 2671 h. 13 x 6 F/01
Art. 2673 h. 13 x 6 F/01



Art. 2513 P
h. 19 x 8 x 9 P/17**

Art. 2627 P
h. 19 x 8 P/17**



Art. 2534
h. 19 x 8 x 9 F/02

Art. 2628
h. 19 x 8 F/02



Art. 7069 P
h. 22 x 12 P/73-A

Art. 7071 P
h. 22 x 11 P/73-A

Art. 7198 P
h. 27 x 14 P/59-B



Art. 7070
h. 20 x 11 F/02

Art. 7072
h. 20 x 10 F/02



Art. 2239 P
h. 17 x 10 x 11 P/A2**

Art. 2240 P
h. 17 x 10 P/A2**



Art. 1260
h. 19 x 12 x 11 F/02



Art. 1939
h. 19 x 14 x 13,5
M/40

Art. 1264 P
h. 21 x 13 x 12 P/28**

Art. 1276 P
h. 21 x 14 P/28**

Art. 1262
h. 19 x 12 F/02

Art. 2179
h. 19 x 14 M/40

Art. 1277 P
h. 31 x 19 P/88**

Art. 1876
h. 28 x 14 F/03

Art. 2180
h. 26 x 16
M/41-8

Art. 2339 R
h. 38 x 22 R/12

Art. 1291 R ■ ■
h. 46 x 26 R/12

Ossari

Art. 2133
h. 13 x 7,5 x 8 F/01

Art. 2194
h. 13 x 7,5 F/01

Ossari

Art. 2941 P
h. 6 x 3,5 x 3,5 P/A8

Art. 2134 P
h. 12 x 7,5 x 8 P/75

Art. 2940 P
h. 8 x 5 x 5 P/A7

Art. 2991 P
h. 8 x 5 P/A7

Art. 2195 P
h. 12 x 7,5 P/75

Adattabile all'accessorio con lucchetto Art. 4000.



Art. 7306 P
h. 20 x 11 P/83

Art. 7311 P
h. 20 x 11 P/83



Art. 7307
h. 20 x 9,5 F/12

Art. 7312
h. 20 x 9,5 F/12



Art. 7306UR
h. 20 x 12 R/93

Art. 7311UR
h. 20 x 11 R/93



Art. 7307U
h. 20 x 10 F/12

Art. 7312U
h. 20 x 9,5 F/12



Art. 7259 R
h. 19,5 x 19 x 12,5 R/A3

Art. 7259 P
h. 19,5 x 19 x 12,5 P/A3

Art. 7260 R
h. 19,5 x 19 x 12 R/A3

Art. 7260 P
h. 19,5 x 19 x 12 P/A3



Art. 7256
h. 21 x 10 x 10 F/12

Art. 7257
h. 21 x 10 x 9 F/12

Art. 7258
h. 25 x 11 x 11 F/03



Art. 7253 R
h. 20 x 13 x 12 R/93-A

Art. 7253 P
h. 20 x 13 x 12 P/83

Art. 7254 R
h. 20 x 13 x 11 R/93-A

Art. 7254 P
h. 20 x 13 x 11 P/83

Art. 7255 R
h. 31 x 17,5 x 16 R/B3

Art. 7255 P
h. 31 x 17,5 x 16 P/29**



Art. 7181 R
h. 10 x 10 x 10 R/01

Art. 7182 R
h. 10 x 10 x 9 R/01

Art. 7183 R
h. 13 x 11 x 11 R/B4



Art. 7261
h. 22 x 14 x 13 M/41-8

Art. 7262
h. 22 x 14 x 12 M/41-8



Art. 7033 9 x 12
Art. 7034 11 x 15



Art. 7062 9 x 12
Art. 7063 11 x 15



Art. 7024 9 x 12
Art. 7025 10 x 15



Art. 7016 9 x 12
Art. 7017 10 x 15



Art. 7259NR
h. 19,5 x 19 x 12,5 R/A3

Art. 7259NP
h. 19,5 x 19 x 12,5 P/A3

Art. 7260NR
h. 19,5 x 19 x 12 R/A3

Art. 7260NP
h. 19,5 x 19 x 12 P/A3



Art. 7181NR
h. 10 x 10 x 10 R/01

Art. 7182NR
h. 10 x 10 x 9 R/01

Art. 7183NR
h. 13 x 11 x 11 R/B4



Art. 7261N
h. 22 x 14 x 13 M/41-8

Art. 7262N
h. 22 x 14 x 12 M/41-8



Art. 7256N
h. 21 x 10 x 10 F/12

Art. 7257N
h. 21 x 10 x 9 F/12

Art. 7258N
h. 25 x 11 x 11 F/03



Art. 7253NR
h. 20 x 13 x 12 R/93-A

Art. 7253NP
h. 20 x 13 x 12 P/83

Art. 7254NR
h. 20 x 13 x 11 R/93-A

Art. 7254NP
h. 20 x 13 x 11 P/83

Art. 7255NR
h. 31 x 17,5 x 16 R/B3

Art. 7255NP
h. 31 x 17,5 x 16 P/29**



Art. 7033N
9 x 12



Art. 7034N
11 x 15

Art. 7062N
9 x 12

Art. 7063N
11 x 15



Art. 7024N
9 x 12

Art. 7025N
10 x 15



Art. 7016N
9 x 12

Art. 7017N
10 x 15



Art. 7242 R
h. 20,5 x 12 x 12,5
R/93-A

Art. 7242 P
h. 20,5 x 12 x 12,5
P/83

Art. 7243 R
h. 20,5 x 12
R/93-A



Art. 7243 P
h. 20,5 x 12 P/83

Art. 7244 R
h. 29 x 15,5 R/88**

Art. 7244 P
h. 29 x 15,5 P/68

Art. 7277 R ■ ■ ■
h. 50 x 25 R/08



Art. 7248 R
h. 19 x 16 x 11,5 R/77**

Art. 7248 P
h. 19 x 16 x 11,5 P/70**

Art. 7249 R
h. 19 x 16 x 11 R/77**

Art. 7249 P
h. 19 x 16 x 11 P/70**

Art. 7446 P
h. 18 x 20 P/87
(sezione ◐)



Art. 7250 P
h. 17 x 27 x 11 P/A74
(sezione ◐)



Art. 7245
h. 20 x 10 x 10,5
F/12



Art. 7279
h. 37 x Ø 19
F/04



Art. 7251
h. 23 x 14 x 14,5
M/41-8

Art. 7246
h. 20 x 10 F/12

Art. 7252
h. 23 x 14
M/41-8

Art. 7247
h. 27 x 11,5 F/03



Art. 7278 R
h. 17 x Ø 19 R/67



Art. 734908
8 x 10

Art. 7349
9 x 12

Art. 7350
11 x 15



Art. 7355
9 x 12

Art. 7356
11 x 15

Art. 7041 R
h. 10 x 10 R/87

Art. 7042 R
h. 10 x 10 R/87

Art. 7043 R
h. 13 x 11 R/84



Art. 7346
9 x 12

Art. 7347
10 x 15



Art. 7352
9 x 12

Art. 7353
10 x 15



Art. 7242NR
h. 20,5 x 12 x 12,5
R/93-A

Art. 7242NP
h. 20,5 x 12 x 12,5
P/83

Art. 7243NR
h. 20,5 x 12
R/93-A



Art. 7243NP
h. 20,5 x 12 P/83

Art. 7244NR
h. 29 x 15,5 R/88**

Art. 7244NP
h. 29 x 15,5 P/68

Art. 7277NR ■■
h. 50 x 25 R/08



Art. 7446NP
h. 18 x 20 P/87

(sezione ☺)

Art. 7248NR
h. 19 x 16 x 11,5 R/77**

Art. 7248NP
h. 19 x 16 x 11,5 P/70**

Art. 7249NR
h. 19 x 16 x 11 R/77**

Art. 7249NP
h. 19 x 16 x 11 P/70**



Art. 7250NP
h. 17 x 27 x 11 P/A74

(sezione ☺)



Art. 7245N
h. 20 x 10 x 10,5
F/12



Art. 7279N
h. 37 x Ø 19
F/04



Art. 7251N
h. 23 x 14 x 14,5
M/41-8

Art. 7246N
h. 20 x 10 F/12

Art. 7252N
h. 23 x 14
M/41-8

Art. 7247N
h. 27 x 11,5 F/03



Art. 7278NR
h. 17 x Ø 19 R/67



Art. 7349N
9 x 12



Art. 7355N
9 x 12

Art. 7350N
11 x 15

Art. 7356N
11 x 15



Art. 7041NR
h. 10 x 10 R/87

Art. 7042NR
h. 10 x 9 R/87

Art. 7043NR
h. 13 x 11 R/84



Art. 7346N
9 x 12

Art. 7347N
10 x 15



Art. 7352N
9 x 12

Art. 7353N
10 x 15



Art. 7248PR
h. 19 x 16 x 11,5
R/77**P



Art. 7245P
h. 20 x 10 x 10,5
F/12



Art. 7242PR
h. 20,5 x 12 x 12,5
R/93-AP



Art. 7251P
h. 23 x 14 x 14,5
M/41-8

Art. 7249PR
h. 19 x 16 x 11
R/77**P

Art. 7246P
h. 20 x 10
F/12

Art. 7243PR
h. 20,5 x 12
R/93-AP

Art. 7252P
h. 23 x 14
M/41-8

Art. 7247P
h. 27 x 11,5
F/03

Art. 7244PR
h. 29 x 15,5
R/88**P



Art. 7346P
9 x 12



Art. 7349P
9 x 12



Art. 7352P
9 x 12



Art. 7355P
9 x 12

Art. 7347P
10 x 15

Art. 7350P
11 x 15

Art. 7353P
10 x 15

Art. 7356P
11 x 15



Art. 7445PP
h. 10,5 x 18 P/59-AP



Art. 7446PP
h. 18 x 20 P/87VE

(sezione )



Art. 7064P
h. 13 x Ø 17 A/01 M/24

Art. 7065P
h. 17 x Ø 17 A/01 M/76-8



Art. 2993 P
h. 22 x 11 x 12 P/73-A

Art. 2994 P
h. 22 x 11 P/73-A

Art. 1812 R
h. 27 x 15 R/56

Art. 1812 P
h. 27 x 15 P/59-B

Art. 2995 P
h. 31 x 15 P/29**



Art. 7084
h. 20 x 11 F/02

Art. 7085
h. 20 x 10 F/02



Art. 2989
h. 23,5 x 13 M/67-8

Art. 2663
h. 23,5 x 14 M/67-8

Art. 1801
h. 27,5 x 15,5
M/48-8



Art. 2612 P
h. 17,5 x 30 x 12 P/70**

Art. 2618 P
h. 17,5 x 30 x 15 P/70**



Art. 2549 P
h. 19 x 13 x 10,5
P/72**

Art. 2551 P
h. 19 x 13 x 7,5
P/72**

Art. 2695 P
h. 30 x 18 x 15
P/88**

Art. 2553 P
h. 30 x 18 x 12
P/88**

Art. 2589 R ■ ■
h. 54 x 31 x 17 R/12



Art. 2550
h. 19,5 x 10 x 9 F/02

Art. 2696
h. 25 x 14 x 11 F/03

Art. 2552
h. 19,5 x 10 x 6 F/02

Art. 2599
h. 25 x 14 x 11 F/03



Art. 1234 P
h. 17,5 x 18 x 10 P/70**

Art. 1235 P
h. 17,5 x 18 x 13 P/70**



Art. 2554
h. 18 x 13 x 10 B/13

Art. 2555
h. 18 x 13 x 7,5 B/13



Art. 7092 P
h. 22 x 14 P/72**

Art. 7091 P
h. 22 x 14 P/72**

Art. 7093 P
h. 28 x 15 P/68



Art. 7073
h. 20 x 11 x 9 F/02

Art. 7074
h. 20 x 11 F/02



Art. 7090 
h. 24 x 14,5 M/38-6



Art. 7200 P
h. 22 x 14 P/72**

Art. 7203 P
h. 22 x 14 P/72**

Art. 7206 P
h. 30 x 15 P/68



Art. 7202 P
h. 20 x 19 x 14 P/70**

Art. 7205 P
h. 20 x 19 P/70**



Art. 7220 
h. 24 x 14,5 M/38-6



Art. 7201
h. 20 x 11 x 9 F/02

Art. 7204
h. 20 x 11 F/02



Art. 7207
9 x 12

Art. 7208
11 x 15



Art. 2890 P
h. 22 x 14 x 12 P/83

Art. 2891 P new
h. 23 x 14 P/83

Art. 2892 P
h. 19 x 19 x 13 P/70**



Art. 2896
h. 21,5 x 14 x 12
M/58



Art. 2894
h. 19,5 x 11 x 9
F/02

Art. 2890 R
h. 22 x 14 x 12 R/54

Art. 2891 R
h. 23 x 14 R/54

Art. 2893 P
h. 20 x 19 P/70**

Art. 2897
h. 22,2 x 14
M/58

Art. 2895
h. 20 x 11
F/02

Art. 1744 R
h. 30 x 17 R/88**

Art. 2898
h. 26,5 x 16
M/59

Art. 1785
h. 24 x 12
F/03

Art. 1744 P
h. 30 x 17 P/88**



Art. 2691
h. 19 x Ø 8 F/02

Art. 2714
h. 19 x Ø 8 F/02



Art. 2356
h. 17 x 8 x 9
B/13



Art. 2690 R
h. 19,5 x 8 x 9 R/54

Art. 2713 R
h. 19,5 x Ø 8 R/54

Ossari

Art. 1616
h. 14 x Ø 6 F/01

Art. 1668
h. 14 x Ø 6 F/01

Art. 2631
h. 17 x Ø 8
B/13

Art. 2690 P
h. 19,5 x 8 x 9 P/60BR

Art. 2713 P
h. 19,5 x Ø 8 P/60BR

Ossari

Art. 1617 P
h. 14 x 7 x 8 P/A2

Art. 1669 P
h. 14 x Ø 7 P/A2



Art. 2804
9 x 12



Art. 1776 P
h. 17 x 32 x 12 P/71**
(sezione ◐)



Art. 2191 P
h. 15,5 x 20 P/71-A
(sezione ◐)



Art. 1974 R
h. 20 x 14 x 12 R/25

Art. 1974 P
h. 20 x 14 x 12 P/74**



Art. 1832
h. 20 x 14 x 12 B/13



Art. 1973
h. 20 x 9 x 9 F/02



Art. 2324
8 x 10

Art. 1161
11 x 15



Art. 1116
8 x 10

Art. 1109
9 x 12

Art. 1110
11 x 15

Art. 1596
13 x 18

Art. 1113
9 x 12

Art. 1484
13 x 18

Art. 1117
10 x 15

-Art. 1485 ■■
18 x 24



Art. 1847 R
h. 20 x 14 x 11
R/25

Art. 1847 P
h. 20 x 14 x 11
P/28**

Art. 2703 P
h. 30 x 20 x 16
P/88**



Art. 1900 R
h. 20 x 14 x 11
R/25

Art. 1900 P
h. 20 x 14 x 11
P/28**

Art. 2687 P
h. 30 x 20 x 16
P/88**



Art. 1846
h. 20 x 13 x 9 F/02

Art. 2702
h. 24 x 17 x 12 F/03

Art. 1899
h. 20 x 13 x 9 F/02

Art. 2686
h. 24 x 17 x 12 F/03



Art. 2701 ◐
h. 25 x 20 x 14
M/29

Art. 2685 ◐
h. 26 x 20 x 13
M/29



Art. 1855
h. 21 x 14 B/13



Art. 1773 P
h. 19 x 32 P/71**

Art. 2270
h. 25 x 14,5 BG/3

Art. 1437 R
h. 21 x 14 R/25

Art. 2244 P
h. 25 x 15 P/73**

Art. 2283 R
h. 34 x 23 R/10

Art. 1437 P
h. 21 x 14 P/74**

Art. 1822 R
h. 30 x 18 R/88**

Art. 2244 R
h. 25 x 15 R/55

Art. 1822 P
h. 30 x 18 P/88**



Art. 2190 P
h. 17 x 18 P/71-A



Art. 2681
h. 28 x Ø 29
M/33-A



Art. 1890
h. 25 x 15 M/33-A



Art. 1438
h. 20 x 11 F/02

Art. 1821
h. 30 x 15 F/03



Art. 2435 P
h. 4,5 x 18,5 P/59-A

Art. 1814
9 x 12

Art. 1815
10 x 15

Art. 1816
13 x 18

-Art. 1817
18 x 24



Art. 1426
9 x 12

Art. 1427
11 x 15

Art. 1428
13 x 18





Art. 2115 R
h. 28 x Ø16 R/68



Art. 1537
h. 22 x Ø16 F/03



Art. 2744 ♦
h. 28 x 16 M/54-8

Art. 2115 P
h. 28 x Ø16 P/53-B



Art. 1897 P
h. 7 x Ø16
P/59-A



Art. 2303
h. 10 x Ø16
A/02 M/69P

vetro ceramico
resistente
alla fiamma



Art. 2000 P
h. 13 x Ø22 P/A1
con griglia G/10P



Art. 2106
h. 31 x 22
F/04

Art. 2000 R
h. 13 x Ø22 R/A1
con griglia G/10P



Art. 2105 R
h. 54 x 30 R/08



Art. 2101 R
h. 26 x 30 R/66



Art. 2103 R
h. 18 x 30 R/66



Art. 2106U
h. 31 x 22 F/04



Art. 2115UR
h. 28 x Ø17 R/68



Art. 1537U
h. 22 x Ø17 F/03



Art. 2744U ♦
h. 28 x 17 M/54-8

Art. 2115UP
h. 28 x Ø17 P/53-B



Art. 2105UR
h. 54 x 30 R/08



Art. 2101UR
h. 26 x 30 R/66



Art. 2000UR
h. 13 x Ø22 R/A1

con griglia G/10P

Art. 2000UP
h. 13 x Ø22 P/A1

con griglia G/10P

Art. 2103UR
h. 18 x Ø30 R/66

senza griglia



Art. 7312U
h. 20 x 10 F/12

♦ Adattabile all'accessorio con lucchetto Art. 4000.



Art. 4070I
h. 23,5 Ø38
P/82

Art. 4546I
h. 26 Ø44
P/A9



Art. 4508I
h. 18 x Ø30 P/41



-Art. 7607 P
h. 2 x 27 x 12,8 P/A73SG



Art. 460308 P2
h. 8 P/A19

Art. 4603 P
h. 17 x 10 x 10 P/A2

Art. 4627 P
h. 20 x 12 x 12 P/28



Art. 4626
h. 20 x 10 x 11
F/02

Serie Delphi



Art. 7058 P
h. 18 x 19 P/87



Art. 7059
h. 23 x 14 F/02

(sezione )



Art. 1327 R
h. 20 x 14 x 10 R/39



Art. 1203
h. 22 x 12,5 x 9,5 F/02



Art. 1338 R
h. 13 x 26 x 9 R/41



Art. 1301 P
h. 20 x Ø 12 P/96**



Art. 1214
h. 21 x Ø 9 F/02



Art. 1304 P
h. 19 x 13 x 11 P/74**



Art. 1331
h. 18 x 13 x 13 F/02



Art. 1795 P
h. 20 x 12 x 11,5 P/28-C



Art. 1796
h. 18 x 10 x 10,5 F/02



Art. 1893 P
h. 18 x 18 x 10 P/70-B



Art. 1423
h. 20 x 15 x 12 M/58-L

Art. 1869 P
h. 20 x 12 P/28-C

Art. 1870
h. 18 x 10 F/02

Art. 1854 P
h. 18 x 18 x 10 P/70-C

Art. 1861
h. 20 x 15 M/58-L

Art. 2753 P
h. 31 x 19 P/29-A

Art. 1480
h. 26 x 16 M/59



Art. 1481 R
h. 19 x 9,5 R/33



Art. 1482
h. 18 x Ø 9,5 F/02



Art. 1479 P
h. 18 x 15 x 12 P/70**



Art. 1487
h. 17 x 13 x 12 M/34

Art. 1850 R
h. 20 x 9 R/33

Art. 1851
h. 19 x Ø 9 F/02

Art. 1824 P
h. 19,8 x 15 x 12 P/70**

Art. 1940
h. 18 x 12 x 10 M/34

Art. 2060 R
h. 30 x 13 R/56

Art. 2061
h. 27 x Ø 10 F/03



Art. 1525 P
h. 21 x Ø 14 P/74**



Art. 1521 R
h. 21 x Ø 14 R/25

-Art. 1781 **h. 25 x 18 x 18 M/09**



-Art. 1848 **h. 22 x Ø 14 BG/3**



Art. 1518
h. 20 x Ø 10 F/02

Art. 1525 R
h. 21 x Ø 14 R/25

-Art. 1541 P **h. 30 x Ø 20 P/88****

-Art. 1779 **h. 23 x 20 x 20 M/06**

Art. 1516
h. 20 x Ø 10 F/02

-Art. 1587 P **h. 34 x Ø 24 P/29****

-Art. 1533 **h. 30 x Ø 16 F/03**

-Art. 1530 R **h. 50 x Ø 31 R/12**



Art. 4121
h. 24,5 x 10 P/A4
PATINA SCURA



Art. 4038
h. 24,5 x 12,5 S/31 fumé
PATINA SCURA



Art. 41631
h. 20 x 10 P/28**



Art. 40561
h. 19 x 10 M/42



Art. 2213 P
h. 27 x 14 P/59**



Art. 2568
h. 26,5 x 15 M/55

Serie Conchiglia



Art. 41041
h. 24 P/73-A

Art. 41051
h. 29 P/A4



Art. 41011
h. 23 M/38

Art. 41021
h. 29 M/55

Serie Quadra



Art. 2368 P
h. 26 x 14 P/53**



Art. 2367 ♦
h. 24 x 14 M/52



Art. 1564 P
h. 22 x 12 P/74**



Art. 1470
h. 21,5 x 13 F/02

Art. 1471
h. 28 x 17 M/02



Art. 7449 P
h. 24 x 10 P/A4



Art. 7374
h. 18,5 x 10
M/41-8

Art. 7372
h. 26 x 14
M/60-8

Art. 7373
h. 22 x 12
M/05

Serie Nordica



Art. 7447 P
h. 24,5 x 10,5
P/A4

Art. 297530 P
h. 30 x 15
P/2901



Art. 2987
h. 23 x 12 M/07

Art. 2975 P
h. 27 x 12
P/A4

Serie Floris



Art. 42011
h. 27 x 10,5 x 10,5
P/7202



Art. 41681
h. 23 x 12,5 x 13,5
M/95BD



Art. 46581 new
h. 22 x 14,5 M/95
doppia apertura



Serie Twist



Art. 2827 P
h. 28 x 17 P/59**



Art. 2828
h. 27 x 14 M/57

Serie Tirolo



Art. 2196
h. 25 x 10 S/15



Art. 40071
h. 27 x 11,5 x 11,5 P/73**

Art. 2197
h. 28 x 12 S/16



Art. 7190 R
h. 21 x 12 x 13 R/25

Art. 7191 R
h. 21 x 12 R/25

Art. 7196 R
h. 31 x 17 R/88-D



Art. 7194
h. 23 x 15 x 13 M/58

Art. 7195
h. 23 x 14 x 13 M/58



Art. 7192
h. 21 x 10 x 9,5 F/12

Art. 7193
h. 21 x 9,5 F/12

Art. 7197
h. 29 x 12 F/03



Art. 7190PR
h. 21 x 12 x 13 R/25

Art. 7191PR
h. 21 x 12 R/25

Art. 7196PR
h. 31 x 17 R/88-D



Art. 7194P
h. 23 x 15 x 13 M/58

Art. 7195P
h. 23 x 14 x 13 M/58



Art. 7192P
h. 21 x 10 x 9,5 F/02

Art. 7193P
h. 21 x 9,5 F/02

Art. 7197P
h. 29 x 12 F/03



-Art. 1190P
9 x 12

-Art. 1191P
11 x 15

-Art. 1192P
13 x 18



-Art. 2032P
9 x 12

-Art. 2033P
11 x 15

-Art. 2034P
13 x 18



-Art. 2142P
9 x 12

-Art. 2143P
11 x 15

-Art. 2144P
13 x 18



-Art. 2035P
9 x 12

-Art. 2036P
11 x 15

-Art. 2037P
13 x 18



■ -Art. 1887 R
h. 33 x 21 R188**



■ -Art. 1896
h. 26 x 15 F/03



■ -Art. 1823
9 x 12

■ -Art. 1825
11 x 15



■ -Art. 1898
h. 27 x 18 M/57



■ -Art. 1871 h. 65 x 30
base 11 x 7

■ -Art. 1872 h. 115 x 53
base 19 x 10



■ -Art. 1843 9 x 12

■ -Art. 1853 13 x 18

■ -Art. 1849 10 x 15

■ -Art. 1862 18 x 24



-Art. 2203 P
h. 20 x 11 x 15
P/74-C

-Art. 2203 R
h. 20 x 11 x 15
R/33



-Art. 2206
h. 30 x 17 x 17 M/59

-Art. 2155
h. 30 x 17 M/59



-Art. 2205
h. 20 x 11 x 12 F/02

-Art. 2211
h. 20 x 11 F/02

-Art. 2173
h. 28 x 14 F/03

-Art. 2207 R
h. 20 x 11 R/33

-Art. 2208 P
h. 32 x 19 P/29**

-Art. 2208 R
h. 32 x 19 R/56



-Art. 1190
9 x 12

-Art. 1191
11 x 15

-Art. 1192
13 x 18



-Art. 2032
9 x 12

-Art. 2033
11 x 15

-Art. 2034
13 x 18



-Art. 2142
9 x 12

-Art. 2143
11 x 15

-Art. 2144
13 x 18



-Art. 2035
9 x 12

-Art. 2036
11 x 15

-Art. 2037
13 x 18



-Art. 7522
h. 20,5 x 12 F/02

-Art. 7523
h. 20,5 x 10,5 F/02

-Art. 7535
h. 25 x 11,5 F/03



-Art. 7518 P
h. 17,5 x 18 x 14,5 P/A3

-Art. 7518 R
h. 17,5 x 18 x 14,5 R/A3

-Art. 7519 R
h. 17,5 x 18 x 13 R/A3



-Art. 7520 P
h. 20,5 x 14 P/72-C

-Art. 7520 R
h. 20,5 x 14 R/93**

-Art. 7521 R
h. 20,5 x 12,5 R/93**

Ossari

-Art. 7525 h. 14 x 8 F/01	-Art. 7524 h. 14 x 7,5 F/01
-------------------------------------	---------------------------------------

Ossari

-Art. 7527 P h. 12 x 7,5 P/75**	-Art. 7526 P h. 12 x 7 P/75**
---	---

-Art. 7528 P
h. 30 x 17 P/29**



■ -Art. 7489
h. 20,5 x 12 F/02

■ -Art. 7490
h. 20,5 x 10,5 F/02

-Art. 7534
h. 25 x 11,5 F/03



■ -Art. 7492 P
h. 17,5 x 18 x 14,5 P/A3

-Art. 7492 R
h. 17,5 x 18 x 14,5 R/A3

■ -Art. 7493 R
h. 17,5 x 18 x 13 R/A3



■ -Art. 7486 P ■ -Art. 7487 R
h. 20,5 x 14 h. 20,5 x 12,5
P/72-C R/93**

-Art. 7486 R -Art. 7533 P
h. 20,5 x 14 h. 30 x 17
R/93** P/29**

Ossari

■ -Art. 7530 ■ -Art. 7529
h. 14 x 8 F/01 h. 14 x 7,5 F/01

Ossari

■ -Art. 7532 P ■ -Art. 7531 P
h. 12 x 7,5 P/75** h. 12 x 7 P/75**

■ Serie Cuore
fusione in bronzo "alta qualità"



■ Serie Cuore-Creta
fusione in bronzo "alta qualità"



-Art. 7500
9 x 12

-Art. 7501
11 x 15



-Art. 7504
9 x 12

-Art. 7505
10 x 15



-Art. 7502
9 x 12

-Art. 7503
11 x 15



-Art. 7506
9 x 12

-Art. 7507
10 x 15

■ Serie Margherita
fusione in bronzo "alta qualità"



■ -Art. 7481
h. 20 x 9 F/02

■ -Art. 7482
h. 20 x 9 F/02



■ -Art. 7484 P
h. 18 x 17 P/A3

-Art. 7484 R
h. 18 x 17 R/A3

■ -Art. 7485 R
h. 18 x 17 R/A3



■ -Art. 7478 P
h. 20,5 x 12,5 P/83

-Art. 7478 R
h. 20,5 x 12,5 R/93**

■ -Art. 7479 R
h. 20,5 x 12,5 R/93**

■ Serie Margherita
fusione in bronzo "alta qualità"





ADESIVO

Art. 4228F
h. 11 R/69D



ADESIVO

Art. 4268F
h. 13 R/28D



ADESIVO

Art. 4233F
h. 11 R/69D



ADESIVO

Art. 4185F
h. 11 R/90D



Art. 1315 R *
h. 13 R/28

Art. 1315 P *
h. 11 P/30



Art. 1321 R
h. 16 R/24



Art. 1320 R
h. 16 R/24



Art. 4235
h. 14,5 R/74
Vite passante
+ Fischer
Through screwed



Art. 4262
h. 14,5 R/74



Art. 1311 R * **Art. 1313 R**
h. 16 R/27 h. 25 R/16

Art. 1312 R **Art. 1314 R**
h. 19 R/21 h. 28 R/11

Art. 1312 P
h. 19 P/21RA



Art. 4273
h. 20 R/80D



Art. 1306 R *
h. 19 R/21

Art. 1307 R
h. 26 R/16



Art. 1323 R
h. 20 R/26



Art. 1322 R
h. 20 R/26



Art. 1553 R
h. 22 R/21

Art. 1403 R
h. 26 R/16

Art. 1405 R
h. 31 R/11



Art. 1548 R
h. 15 R/27

Art. 1549 R
h. 18 R/21

Art. 1550 R
h. 24 R/16

Art. 1551 R
h. 28 R/11

* A richiesta possono essere forniti con attacco adesivo. Chiedere preventivo.



Art. 4228 P new
h. 11 P/30



Art. 4228 PF new
h. 11 P/30



Art. 1320 P new
h. 16 P/32



Art. 1321 P new
h. 16 P/32



Art. 1323 P new
h. 19 P/31



Art. 1322 P new
h. 20 P/31



Art. 4273 P new
h. 20 P/31



Art. 1207
h. 20 x 21 x 10
F/02



Art. 1227
h. 15 x 7 x 9
F/01



Art. 1432
h. 20 x Ø 7
F/02



Art. 1579
h. 16 x 9
F/02



Art. 1223
h. 18 x 7 x 9
F/02

Art. 1228
h. 19 x 7 x 9
F/02

Art. 1224
h. 21 x 8 x 10
F/03

Applicabili su lampade



Art. 1354
vetro bianco
B/02

Art. 1504
vetro rosso
BR/2

h. 24 x Ø 11

Art. 1355
vetro bianco
B/01

Art. 1500
vetro rosso
BR/1

h. 34 x Ø 11



Art. 1507
h. 18,5 x 8
B/08



Art. 7263
h. 3,5 x 2,8

Art. 7229
h. 5 x 3,3



Art. 2325
h. 3,6 x 2,8

Art. 2326
h. 5 x 4



Art. 4541
h. 29 x 11 x 14
M/12



Art. 4542
h. 32 x 11 M/12
base 10,5 x 10,5



Art. 1895
h. 31 x 12
M/12



Art. 1247
h. 27 x 12 x 14
M/12



Art. 2986 ♦
h. 31 x 13
M/41-8



Art. 1274
h. 16 x 8 x 10
B/11



Art. 1282
h. 12 x 8 x 10
B/04



Art. 127800A
h. 17 x 8 x 12
B/08

Rimovibile



Art. 1278
h. 17 x 8 x 12
B/08



Art. 1352
vetro bianco
B/02

Art. 1310
vetro bianco
B/01

Art. 1266
vetro rosso
BR/2

Art. 1265
vetro rosso
BR/1

h. 20 x 11 x 14

h. 30 x 11 x 12



Art. 1890/E
h. 25 x 15
M/33-A F/02L



Art. 2585/E
h. 26 x 15
M/33-B F/02L



Art. 2662/E
h. 19,5 x 13 x 14
M/41-8 F/01L



Art. 2367/E
h. 24 x 14
M/52 F/02L

Art. 2661/E
h. 19,5 x 13 x 14
M/41-8 F/01L



Art. 2984/E
h. 21,5 x 14 x 15
M/41-8 F/01L



Art. 7117/E
h. 21,5 x 14 x 15
M/41-8 F/01L



Art. 14462/E
h. 20 x 16 x 15
M/64-6 F/01L



Art. 2744/E
h. 26 x 17
M/54-8 F/02L

Art. 2971/E
h. 21,5 x 14 x 15
M/41-8 F/01L

Art. 7118/E
h. 21,5 x 14
M/41-8 F/01L

Art. 17432/E
h. 20 x 15
M/64-6 F/01L

Art. 1743/E
h. 23 x Ø 15
M/54-8 F/02L

Accessori per trasformazione Lampade ad Energia Solare



Art. 4970/E
h. 10 x 10 F/02
per lampade elettriche

(ricambio accumulatori
Art. 4973/EC)



Art. 4971/E
h. 10 x 10 F/01L
per lampade a cero



Art. 0730/E
h. 30 x 17
M/04 F/02L



Art. 0862/E
h. 24 x 16
M/35 F/02L



Art. 2606/E
h. 9 x 18,5
A/02 M/08 F/01L
incasso Ø 10



Art. 2288/E
h. 10,5 x Ø 17
A/02 M/24 F/01L

Art. 7188/E
h. 14,5 x Ø 17
A/02 M/76-8 F/01L
incasso Ø 10

Ricambio accumulatori Art. 4903/E, vedi pag. 459.

☛ Predisposta per lucchetto.



Art. 2585
h. 26 x 15
M/33-B



Art. 2664
h. 16 x 11
M/34

Art. 2666
h. 16 x 11
M/34



Art. 7090
h. 24 x 14,5
M/38-6



Art. 7007
h. 24 x 14,5
M/38-6

Art. 2662
h. 21 x 13
M/41-8

Art. 2661
h. 21 x 13
M/41-8

Art. 2661C
h. 26 x 13
M/41-8
Con croce sul
coperchio

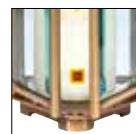

Art. 4335I
h. 24
M/60-8



Art. 4468I
h. 17 x 10
M/97



Art. 7019
h. 11,5 x 10
B/12



Art. 4247I
h. 22 x 11,8
M/60-8



Art. 4658I **new**
h. 22 x 14,5
M/95
doppia apertura

trasformabile a parete
con l'aggiunta
dell'Art. 2289

Art. 7018
h. 11,5 x 9,5
B/12



Art. 4531I
h. 27
M/74 -8



Art. 4122I
h. 25
M/60-8



Art. 2988
h. 27,5 x 15,5
M/48-8



Art. 7565
h. 20,5 x 14 x 10
BG/3



Art. 1591
h. 28 x 15
M/03



Art. 14462
h. 22 x 16 x 15
M/64-6

Art. 17432
h. 22 x 15
M/64-6

Art. 1743
h. 25 x 15
M/54-8



Art. 1591C
h. 33 x 15
M/03

Lampade universali



Art. 101109
h. 21 x 11,5 x 12
M/86-L M/86-P



Art. 101101
h. 25 x 15 x 15
M/81-L M/81-P



Art. 101104
h. 21 x 14 x 14
M/82-L M/82-P



Art. 101102
h. 25 x 15 x 15
M/81-L M/81-P

Rimovibile



Art. 101108
h. 19 x 11,5 x 11,5
M/86-L M/86-P



Art. 101105
h. 25 x 15 x 15
M/84-L M/84-P



Art. 101106
h. 25 x 15 x 15
M/84-L M/84-P

◆ Serie Lumina

LUCE MODULATA - REAL FLAME EFFECT



Art. 5100
h. 15 x 8

Art. 510002
h. 10,5 x 6,5

Art. 510003
h. 8 x 3,5

Applicabili alle fiamme
F/01 - F/02 - F/12

■ Ceri a batteria



ARTICOLI PER OSSARI - VASES/LAMPS FOR COLUMBARIA/NICHES

Ossari

ADESIVI



Art. 7338/H
h. 7,7



Art. 733801/H
h. 7,7



Art. 733802/H
h. 7,7



Art. 733803/H
h. 7,7



Art. 7338W/H
h. 7,7



Art. 7338R/H
h. 7,7



Art. 7338N/H
h. 7,7

Art. 7438/H
h. 12,5

Art. 743801/H
h. 12,5

Art. 743802/H
h. 12,5

Art. 743803/H
h. 12,5

Art. 7438W/H
h. 12,5

Art. 7438R/H
h. 12,5

Art. 7438N/H
h. 12,5



Art. 7333
h. 10,7 x Ø 2,5 x 3,7



Art. 7332 P
h. 6 x Ø 3 x 3,7
P/A8



Art. 7334
h. 11 x 11 x 3,7



Art. 7335
h. 10,5 x 3,5



Art. 7391 P
h. 12,6 x 4,3
P/A13



Art. 756908 P
h. 8 x 4,2 x 4,5
P/39

(sezione ☺)



Art. 2229
h. 17,5 x 4 x 5,5
R/86



Art. 2100
h. 17,5 x Ø 4
R/86



Art. 7097
h. 10 x 5
P/55

Art. 709717
h. 17
P/55

ADESIVO



Art. 7067
h. 13 x 4,5
P/38

Art. 706717
h. 17
P/38

ADESIVO



Art. 4652
h. 17 x 5

Con perno aumento 5%.

Gli articoli adesivi sono disponibili con perno. Aumento 5%.
The adhesive items are also available with 5% surcharge.



Art. 7178 P
h. 14 x 30 P/50 F/01

Art. 2078
7 x 9 cornice



Art. 742801 P
h. 27 x 35 x 12 P/50 F/01
con cornice 7 x 9 Art. 2078



Art. 2611 P
h. 13 x 30 P/35 F/01

Art. 1449
7 x 9 cornice



Art. 742701 P
h. 26 x 35 x 10 P/50 F/01
con cornice 7 x 9 Art. 2078



Art. 2601 P
h. 12 x 30 P/75 F/01

Art. 1449
7 x 9 cornice



Art. 743001 P
h. 27 x 35 x 7 P/75 F/01
con cornice 7 x 9 Art. 1449

Serie Orum



Art. 7431 P
h. 12 x 6 x 6,5 P/43**

Art. 7432 P
h. 12 x 6 P/43**



Art. 7433
h. 14 x 6 x 7 F/01

Art. 7434
h. 14 x 6 F/01

Serie Alliance



Art. 7087 P
h. 14 x 9 x 9 P/50

Art. 7089 P
h. 14 x 9 P/50



Art. 7086
h. 15 x 8 x 8 F/01

Art. 7088
h. 15 x 8 F/01

Serie Herba



Art. 2670 R **Art. 2672 P**
h. 13 x 6 R/53 h. 13 x 6 P/35

Art. 2670 P
h. 13 x 6 P/35



Art. 2671
h. 13 x 6 F/01

Art. 2673
h. 13 x 6 F/01

Serie Quadrifoglio



Art. 1617 P
h. 14 x 7 x 8 P/A2

Art. 1669 P
h. 14 x Ø 7 P/A2



Art. 1616
h. 14 x Ø 6 F/01

Art. 1668
h. 14 x Ø 6 F/01

Serie Iris



Art. 2941 P **Art. 2134 P**
h. 6 x 3,5 x 3,5 P/A8 h. 12 x 7,5 x 8 P/75

Art. 2940 P **Art. 2195 P**
h. 8 x 5 x 5 P/A7 h. 12 x 7,5 P/75



Art. 2133
h. 13 x 7,5 x 8 F/01

Art. 2194
h. 13 x 7,5 F/01

Serie Pegaso



Art. 4146 P **Art. 2697 P**
h. 8,5 x 6 x 5 P/39 h. 11,5 x Ø 6 P/43**

Art. 2638 P
h. 11,5 x 6 x 5 P/43**



Art. 2641
h. 13,5 x Ø 6 F/01

Art. 2698
h. 13,5 x Ø 6 F/01



Art. 755214BZ P
h. 14 x 7 P/50



Art. 708702 P
h. 14 x 9 x 9 P/50



Art. 708701 P
h. 14 x 9 x 9 P/50



Art. 708703R P
h. 14 x 9 x 9 P/50



Art. 708703N P



Art. 708703W P

Serie Dune



■ Art. 730114 P
h.14 x 7 P/75

■ Art. 736314 P
h.14 x 7 P/75



■ Art. 735114
h.14 x 6,5 F/01

■ Art. 736414
h.14 x 6,5 F/01

Serie Solaris



■ Art. 755214 P
h.14 x 7 P/50

■ Art. 755014 P
h.14 x 6,5 P/50



■ Art. 755314
h.14 x 6,5 F/01

■ Art. 755114
h.14 x 5,5 F/01

Serie Egadi



■ Art. 733713 P
h. 13,5 x 7 x 7,5 P/50

■ Art. 734413 P
h. 13,5 x 7 P/50



■ Art. 733914
h. 14 x 8 x 8,5 F/01

■ Art. 734514
h. 14 x 8 F/01

Serie Capri



■ Art. 753908 P
h. 8 x 4,2 x 4,5 P/39

■ Art. 753913 P
h. 12 x 6,5 x 7 P/A11

■ Art. 754413 P
h. 12 x 6,5 P/A11



■ Art. 754014
h. 14 x 7 x 7,5 F/01

■ Art. 754514
h. 14 x 7 F/01

Serie Creta



■ -Art. 7527 P ■
h. 12 x 7,5 P/75**

■ -Art. 7526 P ■
h. 12 x 7 P/75**



■ -Art. 7525 ■
h. 14 x 8 F/01

■ -Art. 7524 ■
h. 14 x 7,5 F/01

Serie Cuore



■ -Art. 7532 P ■
h. 12 x 7,5 P/75**

■ -Art. 7531 P ■
h. 12 x 7 P/75**



■ -Art. 7530 ■
h. 14 x 8 F/01

■ -Art. 7529 ■
h. 14 x 7,5 F/01

Serie Musa



■ Art. 2268
h. 10,5 x 8 x 7,5 B/11



■ Art. 2149 P
h. 9 x 8 x 7,5 P/76



■ Art. 2148
h. 12,5 x 8 F/01

Serie Lute



■ Art. 415107
h. 7

ADESIVI



■ Art. 415208
h. 7,8 x 3,2 F/08

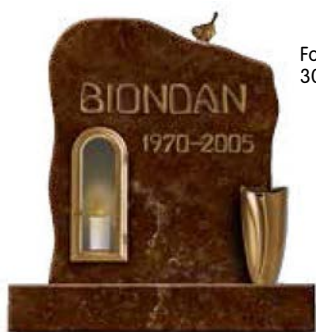

Foro marmo
30,5 x 12

ESEMPIO CON
Art. 702914
h. 32 x 14



ESEMPIO



Art. 702914
h. 32 x 14
S/36 fumè-F-P



Art. 70291411
new



Art. 70291412
new



Art. 7029143



Art. 7029144



Art. 70291417
new



Art. 70291413
new



Art. 70291415
new



ESEMPIO CON
Art. 7480
h. 24,5 x 12,5



Art. 70748001
h. 25 x 12,5
M/32-P



Art. 7480
h. 24,5 x 12,5 M/32-P

Per qualsiasi spessore di marmo



Art. 707480
h. 25 x 12,5
M/32-P



Art. 70748001A
h. 25 x 12,5
M/32-P alluminio



Art. 7633
h. 20 x 18
S/80 fumè F
S/80 fumè P

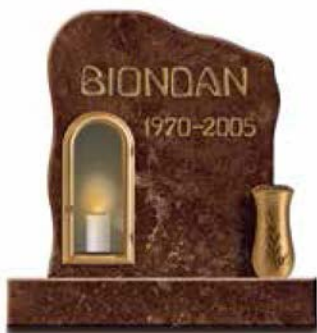

ESEMPIO CON
Art. 702918
h. 37 x 18

Foro marmo
33,5 x 16



ESEMPIO



Art. 702918
h. 37 x 18
S/37 fumè-F-P



Art. 7029181



Art. 7029181
new

Serie Artica patina scura

incasso parete



Art. 7029182



Art. 7029183



Art. 7029184



Art. 7029185
new



Art. 7029186



Art. 7029183
new



ESEMPIO CON
Art. 702818
Ø 18

Foro marmo Ø 16



ESEMPIO



ESEMPIO CON
Art. 735718
h. 21 x 16



ESEMPIO CON
Art. 735421
h. 21 x 17



Art. 7028181



Art. 7028182



Art. 702818 - Ø 18
S/35 fumè-F-P



Art. 739911
h. 14 x 18



Art. 7028183



Art. 7028184



Art. 7028185*
con cornice
Art. 7078 Ø 5,5



Art. 735718
h. 21 x 16



Art. 735421
h. 21 x 17



Art. 735427
h. 27 x 23

Per spessore del marmo 10,5 a 13,5. Per altre misure indicare spessore del marmo sull'ordine.
A richiesta disponibile patina standard - uguale prezzo.



Art. 7436 P
h. 6,5 x 18
P/59-A



Art. 7435
h. 11 x 19
M/77 A/01



Art. 7436NP
h. 6,5 x 18
P/59-AN



Art. 7435N
h. 11 x 19
M/77 A/01



Art. 7445 P
h. 10,5 x 18
P/59-A



Art. 7445NP
h. 10,5 x 18
P/59-A



Art. 7064
h. 13 x Ø 17 A/01
M/24



Art. 7064N
h. 13 x Ø 17 A/01
M/24

Art. 7065
h. 17 x Ø 17 A/01
M/76-8

Art. 7065N
h. 17 x Ø 17 A/01
M/76-8



Art. 2717
h. 10 x Ø 14
M/69P A/04
vetro ceramico
resistente alla
fiamma



Art. 1505 P
h. 4 x Ø 15
P/59-A



Art. 2435 P
h. 4,5 x 18,5
P/59-A



Art. 7129 P
h. 2 x Ø 13
P/59-A



Art. 7644 P
Ø 7 P/50

Art. 764411 P
Ø 11 P/28

Esempio a terreno

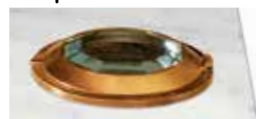

Art. 7050
h. 4 x Ø 10 M/75



Art. 7137
h. 12 x 12 M/27-8

PLAFONIERA



Art. 2820
h. 13 x 18 x 18
M/08 S/02



Art. 1542 P
h. 4 x Ø 16
P/59-A



Art. 1897UP
h. 7 x Ø 16
P/59-A



Art. 1897 P
h. 7 x Ø 16
P/59-A



Art. 2288
h. 10 x Ø 17
A/01 M/24

Art. 7188
h. 14 x Ø 17
A/01 M/76-8



Art. 1346 R
h. 13 x Ø 22
R/91



Art. 2303
h. 10 x Ø 16
A/04 M/69P
vetro ceramico
resistente alla
fiamma



Art. 2626 R
h. 5,5 x Ø 22
R/64



Art. 2303U
h. 10 x Ø 16
A/04 M/69P
vetro ceramico
resistente
alla fiamma



Art. 7392 P
h. 18 x Ø 28 P/18
Foro per incasso 25,5



Art. 2841 P
h. 4 x Ø 19
P/59-A



Art. 2288/E ♦
h. 10,5 x Ø 17
A/02 M/24
F/01L

Art. 7188/E ♦
h. 14,5 x Ø 17
A/02 M/76-8
F/01L

(ricambio
accumulatori
Art. 4903/E)



Art. 2606
h. 9 x 18,5
A/01 M/08



Art. 2607 P
h. 9 x 18,5
P/59-A M/08



Art. 2606/E ♦
h. 9 x 18,5
A/02 M/08 F/01L

(ricambio
accumulatori
Art. 4903/E)

Foro d'incasso Ø 10



Art. 1736
Ø 7 F/02



Art. 7026
h. 13 x Ø 9,5 F/12



Art. 1439
Ø 6 F/01



Art. 1441
Ø 8 F/03



Art. 7632
h. 18 x Ø 16,2 F/03

Art. 1440 Ø 7 F/02 **Art. 1442** Ø 11 F/04





Art. 1624
h. 90 x 32 F/03



Art. 1636
h. 59 x 16 F/02 B/03



Art. 1618
h. 96 x 31 F/03



Art. 1627
h. 96 x 31 F/03

Art. 1626
h. 96 x 36 F/04

Art. 1637
h. 79 x 21 F/03 B/10

Art. 1620
h. 102 x 33 F/04

Art. 1629
h. 102 x 33 F/04



-Art. 1667 ■■
h. 94 x 38
F/04



-Art. 1464 ■■
h. 80 x Ø 26
base Ø 23



-Art. 1463 ■■
h. 87 x Ø 26
base Ø 23 F/04



-Art. 1576 P ■■
h. 70 x Ø 26
base Ø 23 P/29**



-Art. 1599 ■■
h. 102 x 40 M/06



-Art. 1502 ■■
h. 85 x 28 F/04



Art. 1712 ■■
h. 100 x 35 F/04

Esempio con lampada 2997U



Art. 7382U
(lucido/oro)
h. 85 x 22,5 x 8,5

Art. 7382
(bronzato)
h. 85 x 22,5 x 8,5

Preferibilmente per lampade F/03



ESEMPIO
con lampada
Art. 1979



-Art. 1813 ■■
h. 115 x 36



Art. 2647 ■■
h. 100 x Ø 40



Art. 2694 ■■
h. 105 x Ø 46 M/33-A



Art. 2107
h. 100 x 35 F/04



Art. 2107U
h. 100 x 35 F/04



Art. 7280
h. 97 x 35 F/04



Art. 7280N
h. 97 x 35 F/04



Art. 1600
maglia cm
9,5 x 3,5
(prezzo al dm)



Art. 1601
maglia cm
10,6 x 4,5
(prezzo al dm)



Art. 1604
maglia cm
11,2 x 4,5
(prezzo al dm)



Art. 1605
maglia cm
14 x 1,8
(prezzo al dm)



Art. 1682
maglia cm
26,5 x 3,5
(prezzo al dm)



Art. 2245
maglia cm
15 x 3,5
(prezzo al dm)



Art. 1608
h. 60
base Ø 10



Art. 1582
h. 13 x Ø 14



Art. 1877
Ø 4



Art. 1611
Ø 5

Art. 1612
Ø 7



-Art. 1574 ■■
h. 5,5 x 16,5

-Art. 1583 ■■
h. 11 x 30



GRIGLIA DIVISORIA PER INTERNI
IN ALLUMINIO PER FIORIERE ■■



Art. G/03 (1967)

Art. G/04 (1966)

Art. G/01 (1497)

Art. G/10P (2000)
(in plastica)

Art. G/02 (2234)

Art. G/09
(2103-2101)

ART. 4000
DISPOSITIVO CON LUCCHETTO ■■



Art. 4000B
abbinabile all'articolo
1890

Art. 4000C
abbinabile all'articolo
2367

Art. 4000A
abbinabile agli articoli
1743 - 2585 2661
2662 - 2986 - 7090
7220

Art. 4000C1
abbinabile all'articolo
2744



Art. 2289
h. 5 x 6 x 9



-Art. 2285 ■■
h. 5,5 x 9 x 12,5

Art. 2284
h. 5,5 x 6,2 x 12



-Art. 2286 ■■
h. 5,5 x 10 x 17

BRACCETTO PER RENDERE RIMOVIBILI LAMPADE E VASI



Art. 4085
braccetto applicabile
alle lampade
1312P - 1312R - 1423 - 2664



Art. 1934
h. 36 x 15
base Ø 8,5



Art. 1590
h. 36 x 16
base Ø 14



Art. 1936
h. 18,5
base Ø 8,5



Art. 1589
h. 13,5
base Ø 14

Art. 1935
h. 42 x 15
base Ø 9,5

Art. 1937
h. 24,5
base Ø 9,5



Art. 2000UR
h. 13 x Ø 22 R/A1

con griglia G/10P

Art. 2000UP
h. 13 x Ø 22 P/A1

con griglia G/10P



Art. 2103UR
h. 18 x Ø 30 R/66



Art. 2101UR
h. 26 x 30 R/66



Art. 2000 P
h. 13 x Ø 22 P/A1
con griglia G/10P



Art. 2103 R
h. 18 x 30 R/66



Art. 2101 R
h. 26 x 30 R/66

Art. 2000 R
h. 13 x Ø 22 R/A1
con griglia G/10P



Art. 4070I Art. 4546I
h. 23,5 Ø 38 h. 26 Ø 44
P/82 P/A9



Art. 4508I
h. 18 x Ø 30 P/A1



Art. 2234 R
h. 18 x Ø 28 R/50



Art. 1966 R ■■
h. 17 x Ø 35 R/47



Art. 1497 P
h. 21 x Ø 36 P/82



Art. 1967 R ■■
h. 14 x Ø 25 R/48



Art. 2105UR
h. 54 x 30 R/08



Art. 2105 R
h. 54 x 30 R/08



-Art. 7277 R ■■
h. 50 x Ø 25 R/08



-Art. 7277NR ■■
h. 50 x Ø 25 R/08



-Art. 2589 R ■■
h. 54 x 31 R/12



-Art. 1530 R ■■
h. 54 x Ø 31 R/12



Art. 3230 ■■
h. 53 x 30 x 22 R/12
fusione a cera persa



-Art. 2588 R ■■
h. 49 x Ø 24 R/08



-Art. 1707 R ■■
h. 52 x Ø 36 R/12



-Art. 2747 R ■■
h. 52 x 27 R/12



-Art. 1291 R ■■
h. 46 x 26 R/12



Art. 2241 P
h. 19 x Ø 30,5 P/18



Art. 4051IP
h. 20 x Ø 38 P/42



Art. 4079IP
h. 20 x Ø 31 P/41



Art. 4108IP
h. 23 x Ø 38 P/82

CURA LA NOSTRA QUALITÀ CARE OF OUR QUALITY

ARTICOLI IN BRONZO - OTTONE E FINITURE CUBIC SMALTATO BIANCO - BRILLIANT BLACK - MERCURIO PALLADIO

1. Per la pulizia utilizzare solamente panni morbidi e acqua.

L'utilizzo di panni ruvidi può danneggiare la finitura del prodotto e favorirne l'ossidazione.

Si consiglia l'utilizzo del nostro Spray lucidante e conservante LUXOR a base di cera. Non utilizzare prodotti chimici generici.

2. Per il montaggio **NON UTILIZZARE SILICONE ACETICO** e maneggiare con cura.

I prodotti verniciati sono delicati. L'impatto con superfici rigide può danneggiare lo strato protettivo alterando di molto la tenuta alle ossidazioni.

3. I prodotti in bronzo ed ottone tendono ad ossidarsi naturalmente. Seguire le istruzioni sopra riportate per ritardarne l'effetto.

BRONZE - BRASS ARTICLES AND CUBIC - WHITE ENAMEL BRILLIANT BLACK - MERCURIO - PALLADIO FINISHING

1. For cleaning use soft cloths and water only.

Rough cloths might damage the product surface and enhance oxidation.

We recommend our LUXOR polishing and wax base Spray and preservative. Do not use unbranded chemical products.

2. When mounting, **DO NOT USE ACETIC SILICONE** and handle with care. Painted products are delicate.

Contact with hard surfaces might damage the protective layer and accelerate oxidation.

3. Bronze and brass articles tend to oxidate naturally. Please follow the above instructions to delay this effect.



ARTICOLI IN ACCIAIO INOSSIDABILE

1. Lavare gli articoli inox con l'utilizzo di una spugnetta o un panno morbido.

Utilizzare acqua, detersivo neutro oppure prodotti specifici per la pulizia e manutenzione dell'acciaio reperibili in commercio, facendo attenzione che tali prodotti non entrino in contatto con le superfici di marmo sulle quali normalmente sono fissati gli articoli.

Non utilizzare spugne o panni abrasivi che potrebbero rigare la superficie e favorire il deposito di pollini, smog e polvere.

STAINLESS STEEL ARTICLES

1. Wash stainless steel items with a soft cloth.

Use water, neutral detergents or specific products for steel cleaning and maintenance which are commercially available, make sure they do not touch the marble slab on which the articles are normally mounted.

Do not use abrasive cloths which might scratch the surface and enhance pollen, smog and dust deposition.



Cristi, Croci e Applicazioni



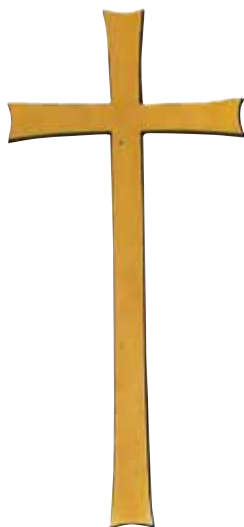

Art. 2943 h. 20 x 11
Art. 2112 h. 50 x 20

Art. 1468 h. 30 x 16
Art. 2113 h. 60 x 22

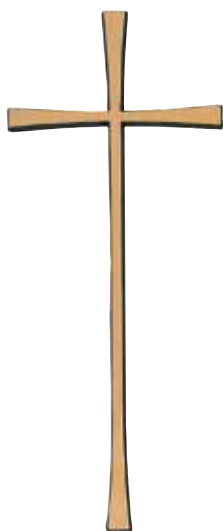

Art. 2111
 h. 40 x 18



Art. 716116 h. 16 x 8
Art. 2216 h. 30 x 13

Art. 7161 h. 25 x 12,5
Art. 2222 h. 40 x 16



Art. 459618 h. 18 x 6,5
 (sezione )
Art. 4596 h. 40 x 16,5
 (sezione )



Art. 459630
 h. 30 x 12,5
 (sezione )



Art. 7264 h. 16 x 9
Art. 7267 h. 40 x 18

Art. 7265 h. 20 x 11
Art. 7268 h. 50 x 22

Art. 7266 h. 30 x 14
Art. 7269 h. 60 x 26

 **-Art. 7270** ■■
 h. 70 x 32
 (sezione )





Art. 2316
 h. 30 x 16

Art. 2317
 h. 40 x 18



Art. 2678 h. 16 x 8
Art. 2604 h. 30 x 13

Art. 2679 h. 20 x 10
Art. 2608 h. 40 x 16

Art. 7162 h. 25 x 12,5
 (sezione )
Art. 2609 h. 50 x 20
 (sezione )

Art. 2610
 h. 60 x 20
 (sezione )

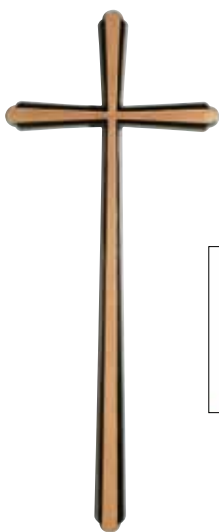



Art. 4596N
 h. 40 x 16,5
 (sezione )



Art. 7036 h. 16 x 9
Art. 27A4 h. 40 x 18

Art. 7037 h. 20 x 11
Art. 7038 h. 50 x 22

Art. 27A3 h. 30 x 14
Art. 7039 h. 60 x 26

 **-Art. 7040** ■■
 h. 70 x 32
 (sezione )



Art. 1488
h. 41 x 21,5



Art. 2523
h. 40 x 19



Art. 2340 **Art. 2342**
h. 30 x 16 h. 50 x 20



Art. 719930
h. 30 x 13
(sezione ▲)

Art. 2524
h. 45 x 24

Art. 2341 **Art. 2343**
h. 40 x 18 h. 60 x 22



Art. 1767
h. 40 x 12
7 x 17 mm

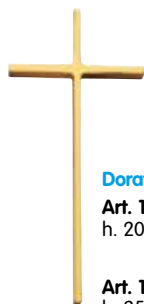

Dorata
Art. 1763U
h. 20 x 9

Art. 1764U
h. 25 x 9

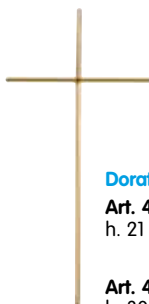

Dorata
Art. 4895U
h. 21 x 10

Art. 4625U
h. 30,5 x 13,7



Art. 2444
h. 40 x 20

Art. 2445
h. 50 x 25

Art. 1760
h. 10 x 5
5 x 10 mm

Art. 1763
h. 20 x 9
6 x 14 mm

Art. 1768
h. 50 x 12
5 x 15 mm

Art. 1761
h. 12 x 7
5,5 x 12 mm

Art. 1764
h. 25 x 9
6 x 14 mm

Art. 1769
h. 60 x 12
5 x 20 mm

Art. 1762
h. 15 x 7
5,5 x 12 mm

Art. 1765
h. 30 x 12
7 x 17 mm
(sezione ■)

Art. 1770
h. 80 x 14
5 x 20 mm



Art. 713617
h. 17 x 6,5



Art. 2382
Distanziale



Art. 7281
h. 16 x 8

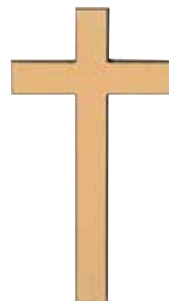

Art. 1738 **Art. 1793**
h. 8 x 4,5 h. 19 x 10

Art. 1792
h. 14 x 8



Art. 2171
h. 40 x 23

Art. 2172
h. 49 x 25



Art. 1614 **Art. 1640**
h. 16 x 8 h. 28 x 16

Art. 1647
h. 24 x 12



Art. 1614N
h. 16 x 8
PATINA ANTICA



Art. 1863
h. 20 x 11

Art. 1856
h. 28 x 15



Art. 2942
h. 24 x 14



Dorata
Art. 2942U
h. 24 x 14



Art. 294201U
h. 24 x 14



Art. 1455
h. 23 x 14



Art. 425614
h. 14 x 7

Art. 4256
h. 22 x 11



CROCE UGONOTTA

Art. 759409
h. 9

Art. 759414
h. 14 x 11



Art. 764305
h. 4,2 x 2

Art. 764307
h. 7 x 3



CROCE DI LORENA
Art. 760014
h. 14 x 8,5



CROCE BASCA
Art. 759514
h. 14 x 14



-Art. 1242 ■■
h. 57 x 29

-Art. 2760 ■■
h. 76 x 40

-Art. 2496 ■■
h. 92 x 48



-Art. 3174 ■■
h. 74 x 41



-Art. 3072 ■■
h. 62,5 x 38



Art. 2372
h. 27 x 13

Art. 1889
h. 40 x 21



Art. 1783
h. 15 x 5

Art. 1784
h. 21 x 7

-Art. 3061 ■■
h. 72 x 24



Art. 1774
h. 20 x 9

Art. 1775
h. 25 x 9



Art. 4214
h. 8 x 5



Art. 1806
h. 14 x 8

Art. 1808
h. 24 x 14



Art. 4857
h. 16 x 8,5



Art. 7381
h. 15 x 9

Art. 1807
h. 19 x 10



Art. 727101
h. 18 x 6,5



Art. 727102
h. 18 x 6,5



Art. 727103
h. 18 x 6,5



Art. 717717
h. 17 x 6,5



Art. 727217
h. 17 x 6,5



Art. 4800
h. 40 x 20



Art. 2537
h. 40 x 19



Art. 2127
h. 20 x 10

Art. 2128
h. 25 x 10

Art. 2129
h. 30 x 10

 **Art. 2232 ■■**
h. 50 x 14



Art. 4117
h. 40 x 16,5

Art. 411730
h. 30 x 12,5



Art. 416401
h. 30 x 12,5



Art. 416402
h. 30 x 12,5



Art. 7648U
h. 21 x 10

Art. 764860U
h. 59 x 25



Art. 4112
h. 40 x 16,5



Art. 4112N
h. 40 x 16,5



Art. 4111
h. 40 x 16,5



Art. 416503
h. 30 x 13

(sezione )

Art. 4817
h. 40 x 16

(sezione )



Art. 4818
h. 40 x 16,5

(sezione )



Art. 459430
h. 30 x 13

(sezione )

Art. 4594
h. 40 x 16

(sezione )



Art. 416501
h. 30 x 13

(sezione )



Art. 416502
h. 30 x 13

(sezione )

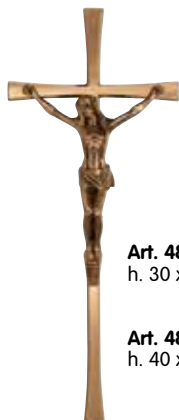

Art. 4841
h. 30 x 12,5

Art. 4802
h. 40 x 16

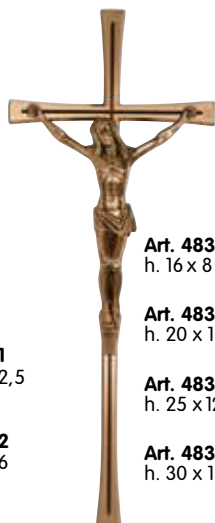

Art. 48316
h. 16 x 8

Art. 483120
h. 20 x 10

Art. 483125
h. 25 x 12,5

Art. 4831
h. 30 x 13

(sezione )



Art. 4816
h. 40 x 16

Art. 483150
h. 50 x 20

Art. 483160
h. 60 x 20

Art. 4814
h. 40 x 19



Art. 4478
h. 40 x 18



Art. 2441
h. 30 x 16

Art. 2442
h. 40 x 18



Art. 4113
h. 40 x 16,5

(sezione )

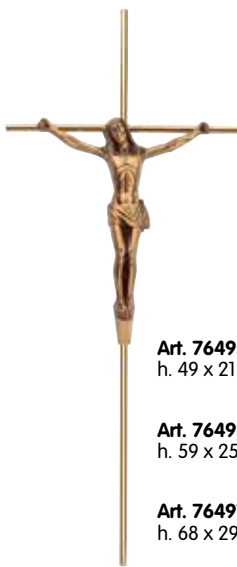

Art. 764950U
h. 49 x 21

Art. 764960U
h. 59 x 25

Art. 764970U
h. 68 x 29,5



Art. 7649U
h. 31 x 14

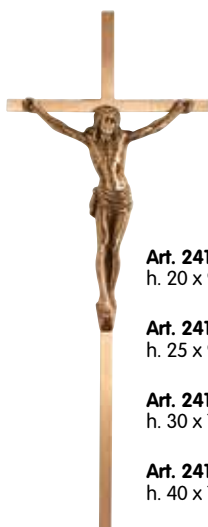

Art. 2413
h. 20 x 9

Art. 2414
h. 25 x 9

Art. 2415
h. 30 x 12

Art. 2416
h. 40 x 12



Art. 4815
h. 40 x 20



Art. 7647
h. 41 x 21,5



Art. 4866
h. 41 x 21,5



-Art. 1237 ■■
h. 57 x 29

-Art. 2759 ■■
h. 76 x 40

-Art. 2495 ■■
h. 92 x 48



-Art. 2536 ■■
h. 47 x 26



Art. 3459 ■■
h. 55 x 31



-Art. 3071 ■■
h. 58 x 49



- Art. 2593
h. 25 x 15,5

Art. 345901 ■■
h. 183 x 31





-Art. 1267 ■■
h. 61 x 29

-Art. 2758 ■■
h. 80 x 40

-Art. 2487 ■■
h. 100 x 48



Art. 2174
h. 48 X 23 base 10 x 8

Art. 2175
h. 57 x 25 base 10 x 8



Art. 27C1 (sezione O)
h. 56 x 22 base Ø 9,5

Art. 7030
h. 66 x 25,5 base Ø 9,5

 -Art. 7031 ■■
h. 80 x 32 base Ø 12



Art. 7273 (sezione O)
h. 56 x 22 base Ø 9,5

Art. 7274
h. 66 x 25,5 base Ø 9,5

 -Art. 7275 ■■
h. 80 x 32 base Ø 12



-Art. 3209 ■■
h. 98 x 31 base 11 x 11



-Art. 3213 ■■
h. 89 x 43 base 11 x 11



-Art. 2509 ■■
h. 55 x 27 base 8 x 8



-Art. 1871 ■■
h. 65 x 30 base 11 x 7



-Art. 2512 ■■
h. 60 x 26 base 8 x 7

-Art. 1739 ■■
h. 107 x 42 base 11 x 6

-Art. 1872 ■■
h. 115 x 53 base 19 x 10

-Art. 3212 ■■
h. 85 x 30 base 11 x 11

-Art. 3208 ■■
h. 97 x 30 base 11 x 11



Art. 3210 ■■
h. 103 x 56 base Ø 15



-Art. 3003 ■■
h. 122 x 70 base 20 x 10



-Art. 3117 ■■
h. 115 x 48 base 20 x 12



-Art. 3152 ■■
h. 66 x 35 base 14 x 6



Disponibile
a parete e
senza Cristo

■ -Art. 3156 ■■
h. 67 x 34 base 13 x 8

-Art. 3153 ■■
h. 117 x 58 base 21 x 11

■ -Art. 3178 ■■
h. 110 x 53 base 17 x 12



Disponibile
senza Cristo

Art. 1420
h. 60 x 26 base Ø 11

Art. 1421
h. 80 x 31 base Ø 14

Art. 1422
h. 100 x 36 base Ø 14



Art. 7546
h. 58 x 22
(sezione D)

Senza Cristo
Art. 7583
h. 58 x 22
(sezione D)



Art. 7547
h. 48 x 18

Art. 7582
h. 56 x 20

Senza Cristo

Art. 7584
h. 48 x 18

Art. 7586
h. 56 x 20



Art. 7549
h. 48 x 18

Senza Cristo
Art. 7585
h. 48 x 18



Art. 3388 ■■
h. 110 x 74 base Ø 32
disponibile senza Cristo
(chiedere preventivo)



-Art. 1259 ■■
h. 61 x 29

-Art. 2757 ■■
h. 80 x 40

-Art. 2486 ■■
h. 100 x 48



Art. 3046 ■■
h. 97 x 52,5

Art. 3044 ■■
h. 103,5 x 52,5 base 29 x 15



Art. 7587
h. 46,5 x 18,5



Art. 758701
h. 46,5 x 18,5



Art. 754601
h. 58 x 22

(sezione ◡)



Art. 754602
h. 58 x 22

(sezione ◡)



 **Art. 399030** ■■
h. 69 x 56 x 15



 **-Art. 3067** ■■
h. 59 x 36

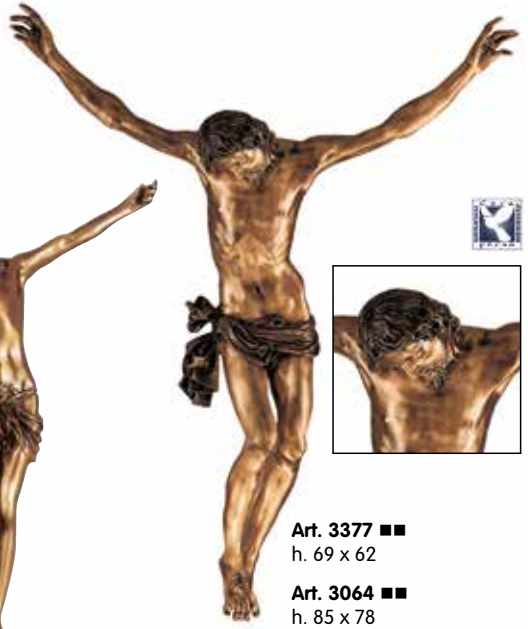

Art. 3377 ■■
h. 69 x 62

Art. 3064 ■■
h. 85 x 78

Art. 3065 ■■
h. 128 x 111

Art. 3066 ■■
h. 192 x 150

Disponibile con croce in legno (vedi pag. 137)



 **-Art. 3108** ■■
h. 62 x 47



 **-Art. 3106** ■■
h. 45 x 31,5



 **Art. 3307** ■■
h. 73 x 65



Art. 4801
h. 30 x 22



Art. 3436
h. 78 x 51



Art. 3406
h. 55 x 38



Art. 3107
h. 41,5 x 31,5



Art. 1857
h. 24 x 17



Art. 1910
h. 26 x 18



Art. 2636
h. 19 x 13



Art. 1911
h. 29 x 20



Art. 1538
h. 8 x 6



Art. 1685
h. 5

Art. 1687
h. 8

Art. 1686
h. 6

Art. 1688
h. 10

Art. 1786
h. 22 x 17

Art. 1804
h. 28 x 21

Art. 1689
h. 17

Art. 1690
h. 20

-Art. 1700 ■■ 

-Art. 1701 ■■ 

Art. 1539
h. 11 x 8

Art. 1540
h. 14 x 10



Art. 1789
h. 1,5 x 0,8

Art. 1791
h. 3 x 2,7

Art. 1790
h. 2 x 1

-Art. 1957 ■■ 

-Art. 3253 ■■  h. 46 x 32



Art. 1053
h. 4,5 x 5



Art. 4118
h. 6,5 x 4



Art. 2584
h. 9,5



Art. 2583
h. 9,5



Art. 2434
h. 9,8



Art. 1756
h. 10



Art. 4650
h. 10 x 6



Art. 4649
h. 10 x 8



Art. 1602 **Art. 1651**
h. 10 h. 15



Art. 4859
h. 11,5 x 7



Art. 2503
h. 12,5



Art. 2354
h. 12,8



Art. 4011
h. 13,5 x 6,5



Art. 2651
h. 13,6



Art. 4860
h. 15 x 17



Art. 2473
h. 13



Art. 4133
h. 14 x 11



Art. 2472
h. 15



Art. 4861
h. 17 x 8



Art. 2373
h. 17,5



Art. 2470
h. 18



Art. 2471
h. 20



Art. 1491
h. 20 x 15

Predisposta solo per
l'applicazione sui libri
Art. 1492, 7051, 2725.



Art. 2581/S
h. 21



Art. 2581/D
h. 21



Art. 2649
h. 21



Art. 1881
h. 22



Art. 2669
h. 23,5



Art. 1401
h. 11,5



Art. 1402
h. 34 x 25



Art. 1649
h. 13



Art. 1648
h. 39 x 18

Art. 1376
h. 18

Art. 2740
h. 21



Art. 2381
h. 28 x 13



Art. 2375/S
h. 24



Art. 2375/D
h. 24



Art. 2379
h. 37 x 18



Art. 1961
h. 30 x 13



Art. 1188
h. 32



Art. 2532
h. 26



Art. 4645
h. 20 x 10



Art. 4646
h. 42 x 20

Art. 4647
h. 32 x 17



Art. 1852/S
h. 30 x 16

Art. 1964/S
h. 46 x 31

Art. 1956/S
h. 43 x 28



Art. 1963
h. 60 x 18



Art. 1852/D
h. 30 x 16

Art. 1964/D
h. 46 x 31

Art. 1956/D
h. 43 x 28



Art. 1965
h. 40 x 15



 **-Art. 1495 ■■**
h. 38 x 19



Art. 1962
h. 46 x 19



Art. 2380
h. 44 x 14



Art. 7612
h. 25 x 12



Art. 7612DG
h. 25 x 12



Art. 7612DR
h. 25 x 12



Art. 7612DW
h. 25 x 12



Art. 7612DRG
h. 25 x 12



Art. 7612CG
h. 25 x 12



Art. 7612CR
h. 25 x 12



Art. 7612CW
h. 25 x 12



Art. 7612CRG
h. 25 x 12



Art. 7612CWG
h. 25 x 12



Art. 7615
h. 26 x 16



Art. 7615DG
h. 26 x 16



Art. 7615DR
h. 26 x 16



Art. 7615DW
h. 26 x 16



Art. 7615CG
h. 26 x 16



Art. 7615CR
h. 26 x 16



Art. 7615CW
h. 26 x 16



Art. 7613
h. 34 x 12



Art. 7613DG
h. 34 x 12



Art. 7613DR
h. 34 x 12



Art. 7613DW
h. 34 x 12



Art. 7613CG
h. 34 x 12



Art. 7613CR
h. 34 x 12



Art. 7613CW
h. 34 x 12



Art. 7611
h. 24,5 x 4,2



Art. 7611DG
h. 24,5 x 4,2



Art. 7611DR
h. 24,5 x 4,2



Art. 7611DW
h. 24,5 x 4,2



Art. 7611CG
h. 24,5 x 4,2



Art. 7611CR
h. 24,5 x 4,2



Art. 7611CW
h. 24,5 x 4,2



Art. 7608
h. 30,5 x 13

Art. 7609
h. 31,5 x 15



Art. 7608DW
h. 30,5 x 13



Art. 7608CW
h. 30,5 x 13



Art. 7609DW
h. 31,5 x 15



Art. 7609CW
h. 31,5 x 15



Art. 7616
h. 25 x 6,5

Art. 7617
h. 29,5 x 8



Art. 7616DW
h. 25 x 6,5



Art. 7616CW
h. 25 x 6,5



Art. 7617DW
h. 29,5 x 8



Art. 7617CW
h. 29,5 x 8



Art. 1376CG
h. 18



Art. 1376CR
h. 18



Art. 1376CW
h. 18



Art. 1881CG
h. 22



Art. 2380CG
h. 44 x 14



Art. 2380CR
h. 44 x 14



Art. 2380CW
h. 44 x 14



Art. 1881CR
h. 22



Art. 1961CG
h. 30 x 13



Art. 1961CR
h. 30 x 13



Art. 1961CW
h. 30 x 13



Art. 1881CW
h. 22



Art. 1965CG
h. 40 x 15



Art. 1965CR
h. 40 x 15



Art. 1965CW
h. 40 x 15



Art. 1962CG
h. 46 x 19



Art. 1962CR
h. 46 x 19



Art. 1962CW
h. 46 x 19



Art. 2381CG
h. 28 x 13



Art. 2381CR
h. 28 x 13



Art. 2381CW
h. 28 x 13



Art. 7606 ■■
h. 3 x 3



Fedi Nuziali
Art. 7187
h. 3 x 4,7



Art. 4598
h. 9



Art. 4648
h. 9 x 7

Art. 4570
h. 18 x 14



Art. 4862
h. 21 x 10



Art. 4882
h. 19 x 8



Art. 4864
h. 14 x 10



Art. 4864CR new
h. 14 x 10



Art. 4863
h. 10 x 7,5

Art. 2964
h. 36 x 16

Art. 4870
h. 20 x 14



Art. 429901
h. 11,5



Art. 429902
h. 14



Art. 429903
h. 18



Art. 429904
h. 19



Art. 429905
h. 18



Art. 4622
h. 7 x 12



Art. 4589
h. 9,5 x 13



Art. 4631
h. 7 x 10



Art. 4623
h. 9 x 12

Art. 4612
h. 9 x 16



Art. 4613
h. 8 x 10



Art. 4883
h. 15 x 14

Art. 4878
h. 20 x 16



Art. 4585
h. 7 x 10

Art. 4584
h. 26 x 33

Art. 4900
h. 14 x 18



Art. 4586
h. 10 x 11

Art. 4499
h. 34 x 34

Art. 4498
h. 19 x 21



Art. 7618 ■■
h. 7,5 x 8



Art. 7619 ■■
h. 4 x 5,5



Art. 76193 ■■
h. 3 x 3



Art. 7618U ■■
h. 7,5 x 8



Art. 7619U ■■
h. 4 x 5,5

DORATE



Art. 7618CR ■■
h. 7,5 x 8



Art. 7619CR ■■
h. 4 x 5,5



Art. 76193CR ■■
h. 3 x 3

DIPINTE A MANO



Art. 7618AG ■■
h. 7,5 x 8



Art. 7619AG ■■
h. 4 x 5,5

ARGENTATE



Art. 7618CN ■■
h. 7,5 x 8



Art. 7619CN ■■
h. 4 x 5,5



Art. 76193CN ■■
h. 3 x 3

DIPINTE A MANO



Art. 7618RA ■■
h. 7,5 x 8



Art. 7619RA ■■
h. 4 x 5,5

RAMATE



Art. 7618CW ■■
h. 7,5 x 8



Art. 7619CW ■■
h. 4 x 5,5



Art. 76193CW ■■
h. 3 x 3

DIPINTE A MANO



Art. 4131
h. 9 x 12



Art. 4132
h. 11,5 x 12,5



Art. 4884
h. 9 x 17



Art. 4803
h. 13 x 11



Art. 2002
h. 7 x 14



Art. 2738
h. 10 x 10

Art. 2755
h. 14 x 13



Art. 7130/S
h. 3,5 x 9



Art. 7130/D
h. 3,5 x 9



Art. 7131/S
h. 3,5 x 9



Art. 7131/D
h. 3,5 x 9



Art. 4587
h. 7 x 5



Art. 4885
h. 10 x 8



Art. 717901
h. 7 x 7,5

Art. 717902
h. 9 x 9



Art. 1999
h. 9 x 11

Art. 2005
h. 13,5 x 18



Art. 1998
h. 13 x 7

Art. 2003
h. 18 x 9



Art. 707902
h. 9,5 x 13,5



Art. 707901
h. 5 x 13



Art. 707903
h. 7 x 12,5



Art. 4639
h. 7 x 9



Art. 4588
h. 13 x 9,5



Art. 4821 **Art. 4822**
h. 8 x 12 h. 18 x 24



Art. 4049 **Art. 7168**
h. 7 x 12 h. 22 x 36

Art. 4050
h. 9,5 x 16



Art. 2225
h. 10 x 10

Art. 2226
h. 14 x 14

Art. 2756
h. 28 x 27



Art. 249705/S
h. 5 x 3,2



Art. 249705/D
h. 5 x 3,2

Art. 249710/S
h. 10 x 6,5

Art. 249710/D
h. 10 x 6,5

Art. 2497/S
h. 15 x 9,5

Art. 2497/D
h. 15 x 9,5



Art. 4640
h. 20 x 14

Art. 4642
h. 36 x 23



Art. 2544
h. 10 x 26



Art. 4886
h. 6,5 x 19



Art. 4824
h. 19 x 13



Art. 4804
h. 21 x 17



Art. 2193
h. 28 x 17

Art. 4805
h. 27 x 23



Art. 4599
h. 9,5 x 19



Art. 4597
h. 11 x 18,5



Art. 4544
h. 30 x 21



Art. 4543
h. 28 x 26,5



Art. 1197
Ø 11

-Art. 1374 ■■
Ø 21

-Art. 137430 ■■
Ø 30



Art. 759814
h. 14



Art. 759714
h. 14

Art. 759721
h. 21



Art. 124611 ■■
h. 11

-Art. 1246 ■■
h. 21



-Art. 1189 ■■
h. 18 x 18



Art. 759614
h. 14 x 12

Art. 759618
h. 18



Art. 4533
h. 11 x 6

Art. 4534
h. 16 x 9



-Art. 1196 ■■
h. 16 x 42

-Art. 7491 ■■
h. 18 x 54



Art. 2145
h. 7 x 23



Art. 4500
h. 7 x 23



Art. 4880
h. 7 x 23



Art. 4881
h. 7 x 23



Art. 7283
h. 5,5



Art. 7282
h. 5,5



Art. 2556
h. 11



Art. 2558
h. 11,5



Art. 7166N
h. 14,5 x 10
PATINA ANTICA



Art. 7167N
h. 14,5 x 9
PATINA ANTICA



Art. 1837
h. 12



Art. 1838
h. 17

Art. 1834
h. 12

Art. 1835
h. 17



Art. 7166
h. 14,5 x 9,5

Art. 2098/S
h. 20



Art. 7167
h. 14,5 x 9



Art. 2097
h. 19



Art. 2098
h. 20



Art. 1343/S
h. 16



Art. 1343/D
h. 16



Art. 1988
h. 24



Art. 1990
h. 23,5



Art. 2304/S
h. 20



Art. 2304/D
h. 20



Art. 4809
h. 9 x 6,5

Art. 4812
h. 16 x 12



Art. 1400
h. 15



Art. 2737
h. 12 x 10



Art. 1334
h. 8

Art. 1398
h. 13



Art. 2347
h. 9



Art. 4858 **Art. 1907**
h. 9 x 6 h. 25 x 17



Art. 2735 **Art. 2736**
h. 10 h. 20



-Art. 1811 ■■
h. 22

Art. 2412
h. 15 x 9

Art. 2743
h. 14



Art. 2830
h. 15,5 x 12



Art. 2251
h. 16,5



Art. 2418
h. 15,5



Art. 2231
h. 24



Art. 2485
h. 25,5



Art. 2600
h. 29 x 16



-Art. 2617 ■■
h. 30 x 25



 -Art. 1797 ■■
h. 30 x 20



 -Art. 3101 ■■
h. 28 x 23



 -Art. 3158 ■■
h. 36 x 30



 -Art. 1867 ■■
h. 30 x 25



 -Art. 1630 ■■
h. 26



 -Art. 3416 ■■
h. 22 x 19



 **Madonna di Lourdes**
-Art. 3487 ■■
h. 29 x 24 x 2



Cristo Risorto
Art. 703507
h. 7,5
Art. 703510
h. 10,5
Art. 703515
h. 15



Sacro Cuore
Art. 7077
h. 28 x 10



 -Art. 3225 ■■
h. 43 x 34



 -Art. 3109 ■■
h. 44 x 43



Art. 2346
h. 8,5



Art. 1486
h. 15



Art. 1818
h. 23,5



Art. 7228
h. 18 x 18



 **-Art. 3418 ■■**
h. 12 x 13



Art. 2675
h. 12

Art. 2680
h. 16

Art. 2676
h. 20



Madonna di Czestochowa

 **-Art. 4296 ■■**
h. 18 BRONZO ALTA QUALITÀ



Art. 1212
h. 24 x 13



Art. 1820
h. 19



 **Art. 3400 ■■**
h. 50 x 36 x 14



 **Art. 3322 ■■**
h. 39 x 36



Art. 7076
h. 20 x 10

Art. 1833
h. 39 x 17



Art. 2642
h. 29 x 12



 **-Art. 346001** ■■
h. 35 x 11



 **-Art. 346002** ■■
h. 35 x 11

Art. 1827
h. 28 x 12

Art. 2950
h. 48 x 20

Art. 2630
h. 41 x 17



Art. 2348
h. 41



 **-Art. 3339** ■■
h. 42



Madonna con bambino

 **Art. 388020** ■■
h. 183



 **Art. 3379 ■■**
h. 60



 **Art. 1924 ■■**
h. 36 x 15 x 10



 **-Art. 3256 ■■**
h. 58



 **-Art. 3254 ■■**
h. 56



Padre Pio
Art. 730001OT
h. Ø 5



Padre Pio
Art. 7186
h. 14,5 x 14,5



Padre Pio
Art. 7289
h. 13 x 11,5



Padre Pio
Art. 7300
h. 21 x 13



Papa G. Paolo II
Art. 7542P
h. 16,5 x 11



Papa G. Paololi
Art. 7542
h. 16,5 x 11



S. Antonio
-Art. 4264
h. 21



S. Francesco
-Art. 4269
h. 19



S. Giuseppe
-Art. 4265
h. 23

-Art. 4492
h. 19



S. Anna
-Art. 4283
h. 23



S. Michele
-Art. 4285
h. 23



S. Pietro
-Art. 4278
h. 23



Madonna di Guadalupe
-Art. 417615 ■ ■
h. 15
-Art. 4176 ■ ■
h. 25



S. Giovanni
-Art. 4281
h. 23



S. Antonio
-Art. 4277
h. 23



Sacro Cuore
-Art. 4286
h. 29



S. Francesco
-Art. 4280
h. 23



S. Giuseppe
-Art. 4189
h. 23



S. Giuda
-Art. 4187
h. 23



S. Lazzaro
-Art. 4180
h. 23



S. Patrizio
-Art. 4186
h. 23



Madonna di Fatima
-Art. 4284
h. 23



S. Teresa
-Art. 4279
h. 23



S. Barbara
-Art. 4181
h. 23



Madonna di Guadalupe
-Art. 4282
h. 23



 **Art. 3470 ■■**
h. 12,5 x 10,6 x 10



Art. 2462
h. 8,3 x 13,4



Art. 7155
h. 14,5 x 7



Art. 7156
h. 15 x 7



Art. 2074/S
h. 12



Art. 2074/D
h. 12



Art. 113407/S
h. 7



Art. 113407/D
h. 7



Art. 7614/S
h. 20,5



Art. 7614/D
h. 20,5

Art. 113410/S
h. 10

Art. 113410/D
h. 10

Art. 1134/S
h. 18

Art. 1134/D
h. 18



Art. 399029 ■■
h. 34 x 41 x 15



Art. 3465 ■■
h. 48 x 48



-Art. 3100/S ■■
h. 36 x 24



-Art. 3100/D ■■
h. 36 x 24



-Art. 3133 ■■
h. 56 x 29



-Art. 1256 ■■
h. 45 x 29



Art. 1713
h. 14 x 14



 -Art. 1892 ■■
h. 30 x 12



 -Art. 1631 ■■
h. 34 x 34



 -Art. 1619 ■■
h. 31 x 48



 -Art. 1633 ■■
h. 37 x 47



 -Art. 2399 ■■
h. 79 x 47



 -Art. 1632 ■■
h. 42 x 53



 -Art. 1677 ■■
h. 41 x 36



 -Art. 3192 ■■
h. 46 x 34



 -Art. 3155 ■■
h. 50 x 28



 -Art. 3415 ■■
h. 48 x 19



Art. 2674
h. 33 x 22



 -Art. 3081 ■■
h. 44 x 62

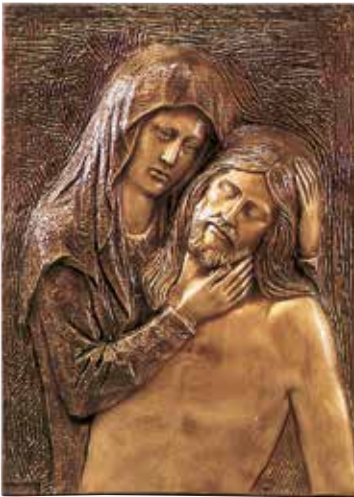

 -Art. 3226 ■■
h. 75 x 56



 -Art. 3182 ■■
h. 51 x 31

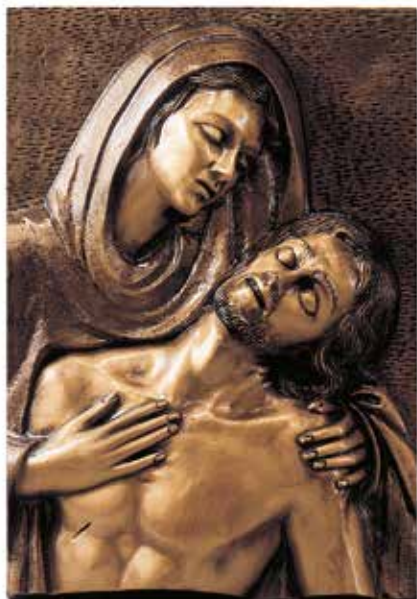

 -Art. 2398 ■■
h. 50,5 x 34



Art. 2521
h. 50 x 15



Art. 2522
h. 50 x 15



 -Art. 3227 ■■
h. 56 x 34



 -Art. 3077 ■■
h. 60 x 40



-Art. 3414 ■■
h. 43 x 31



-Art. 1908 ■■
h. 33 x 25



-Art. 3417 ■■
h. 25 x 18



-Art. 1473 ■■
h. 37 x 27



-Art. 3151 ■■
h. 37 x 28



-Art. 2300 ■■
Ø 39



-Art. 1842 ■■
Ø 24



-Art. 3102 ■■
Ø 23



-Art. 1844 ■■
Ø 24



-Art. 1913 ■■
h. 49 x 31



-Art. 3351 ■■
h. 49 x 33



-Art. 3352 ■■
h. 49 x 33



■ Art. 3112 ■■
h. 73 x 180



■ Art. 3279 ■■
h. 89 x 80 x 14 (aperta dietro)

■ Art. 3274 ■■
h. 89 x 80 x 14 (chiusa dietro)
base 56 x 12,5



■ Art. 3277 ■■
h. 96 x 82 x 16 (aperta dietro)

■ Art. 3278 ■■
h. 96 x 82 x 16 (chiusa dietro)
base 14 x 11



■ -Art. 3119 ■■
h. 59 x 70



■ -Art. 3146 ■■
h. 56 x 37



Art. 3113 ■■
h. 73 x 90



 -Art. 2246 ■■
h. 48 x 14



 -Art. 2247 ■■
h. 48 x 14



 -Art. 2248 ■■
h. 48 x 14



 -Art. 2249 ■■
h. 48 x 14



 -Art. 3162 ■■
h. 53 x 14



Art. 3382 ■■
h. 124 x 124 x 8



Ultima Cena
Art. 3300 ■■
h. 23 x 78 x 5,5



-Art. 3148 - I stazione

FORMELLE VIA CRUCIS ■■
h. 28 x 20 x 7



-Art. 3149 - II stazione



-Art. 3185 - III stazione



-Art. 3189 - IV stazione



-Art. 3186 - V stazione



-Art. 3183 - VI stazione



-Art. 3191 - VII stazione



-Art. 3147 - VIII stazione



-Art. 3184 - IX stazione



-Art. 3150 - X stazione



-Art. 3190 - XI stazione



-Art. 3195 - XII stazione



-Art. 3194 - XIII stazione



-Art. 3193 - XIV stazione



-Art. 3466 - XV stazione

le Statue





Patinatura statue



PATINA
ARTISTICA



VERDE
POMPEIANO



PATINA
CLASSICA

Esempi di statue con finitura in patina artistica



Art. 3223 ■■
h. 275 x 134 x 102



Art. 3423 ■■
h. 265 x 135 x 110



Art. 3433 ■■
h. 222 x 120 x 50



**Cristo in bronzo fuso
a cera persa**

Art. 3066C ■■

Croce in legno lamellare
h. 300 x 180 cm

Cristo Art. 3066
h. 192 x 150 cm

Sistema di fissaggio
a parete ed a sospensione





Ultima cena
realizzazione a tutto tondo

Art. 3344 ■■
h. 90 x 232 x 60



 -Art. 3205 ■■
h. 45 x 18

 -Art. 3206 ■■
h. 56 x 23

 Art. 3207 ■■
h. 107 x 36





 -Art. 3272 ■■
h. 126 x 59 x 50
base 41 x 50



 Art. 3049 ■■
h. 100 base 16 x 18



 -Art. 3022 ■■
h. 55 x 42
base 32 x 25

 -Art. 3266 ■■
h. 55 x 42
base 32 x 25



 -Art. 3216 ■■
h. 56 x 21 x 14

 -Art. 3196 ■■
h. 87 x 44 x 25



 Art. 3197 ■■
h. 170 x 65 x 42

 -Art. 3198 ■■
h. 56 x 21 x 14



 -Art. 3231 ■■
h. 110 x 30 x 26 - base 29 x 18
(a richiesta con base rotonda
Ø 20 cm a prezzo invariato.)

(chiusa dietro)



Pietà del Michelangelo
ricavata dal calco originale
in S. Pietro

Art. 3221 ■■
h. 174 x 170 x 83

Disponibile come Applicazione:

Art. 3385 ■■
h. 160 x 152 x 34



Art. 3011 ■■
h. 170 x 52 - base 40 x 50



Art. 3099 ■■
h. 125 x 42 - base 44 x 37



Art. 3094 ■■
h. 90 x 80
base 61 x 45



Art. 3019 ■■
h. 88 x 56
base 55 x 53



Art. 3265 ■■
h. 52 - base 35 x 16

Art. 3008 ■■
h. 104 - base 65 x 40



Art. 3002 ■■
h. 82 x 62
base 57 x 54

Art. 3137 ■■
h. 72 - base 50 x 24

Art. 3211 ■■
h. 120 - base 100 x 50



 -Art. 3034 ■■
h. 86 x 61
base 55 x 12
applicazione



Art. 3308 ■■
h. 18,5
base 15 x 6,5

Art. 3298 ■■
h. 42
base 32 x 15

Art. 3309 ■■
h. 31
base 24,5 x 11



 -Art. 3268 ■■
h. 68 x 70
base 60 x 34



Art. 3199 ■■
h. 100 x 35
base Ø 38



-Art. 3295 ■■
h. 70 x 32
base 21 x 18



Art. 3129 ■■
h. 58
base 17 x 20



Art. 3048 ■■
h. 58 x 58
base 58 x 26



Art. 3069 ■■
h. 76 x 90
base 70 x 50



Art. 3486 ■■
h. 184 x 63 x 34
base 50 x 48



Art. 3494 ■■
h. 179 x 63 x 45



Art. 3299 ■■
h. 172 x 52 - base 49 x 42



Art. 3115 ■■
h. 110 x 107 - base 90 x 40



Art. 3168 ■■
h. 175 x 120
base Ø 60



Art. 3331 ■■
h. 120 x 55
base 36 x 38



Art. 3024 ■■
h. 106 x 47
base 27 x 40



-Art. 3346 ■■
h. 100 x 50



Art. 4421 ■■
h. 80 x 30 x 20



-Art. 3428 ■■
h. 80 x 30 x 17



-Art. 3294 ■■
h. 84 x 26
base 20 x 16



-Art. 3370 ■■
h. 112 x 39
base 24 x 21



Art. 3033 ■■
h. 60 x 34 x 25
base Ø 15,5



Art. 3026 ■■
h. 59
base 13 x 13



-Art. 3427 ■■
h. 63 x 20 x 12



Art. 3092 ■■
h. 80 x 28
base 18 x 16



-Art. 3348 ■■
h. 62 x 29



-Art. 3305 ■■
h. 35 x 12



Art. 3407
h. 28 x 10



 -Art. 3311 ■■
h. 80 x 67
base 23 x 20



Art. 3236 ■■
h. 106 x 43
base 28 x 26



 -Art. 3296 ■■
h. 101 x 47
base 23 x 20



-Art. 3281 ■■
h. 56 - base 14 x 12



Art. 3027 ■■
h. 84 x 50
base 20 x 20



 -Art. 3314 ■■
h. 88 x 52
base 23 x 20

-Art. 3283 ■■
h. 80 - base 17 x 15



Art. 3097 ■■
h. 95 x 52
base 48 x 55



Art. 3122 ■■
h. 120 x 77
base 40 x 78



Art. 3293 ■■
h. 121 x 47 x 67



Art. 3219 ■■
h. 85 x 38
base 25 x 58



 **-Art. 3202 ■■**
h. 65 x 36



 **-Art. 3315 ■■**
h. 69 x 40
base 33 x 40



Art. 3167 ■■
h. 110 x 50
base 35 x 30



Art. 3055 ■■
h. 118 x 38
base 29 x 26



Art. 3005 ■■
h. 115 x 40
base 27 x 32

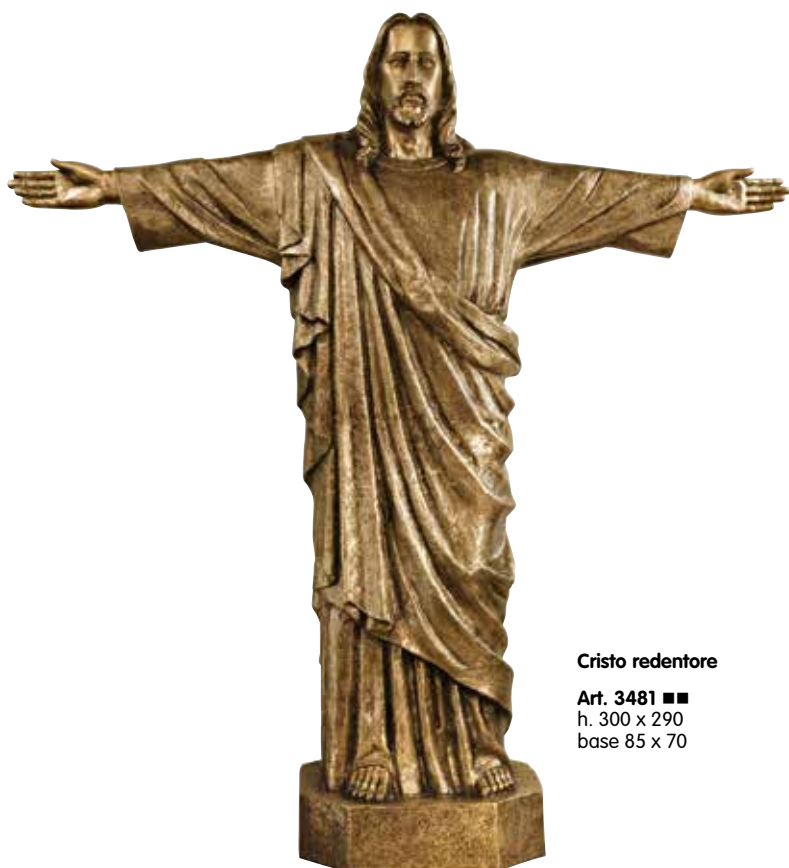

Cristo redentore

Art. 3481 ■■
h. 300 x 290
base 85 x 70



Art. 3040 ■■
h. 170 x 60 - base 55 x 40



Art. 3039 ■■
h. 120 x 50 - base Ø 32



Art. 3456 ■■
h. 64 x 28



Art. 3037 ■■
h. 80 x 34 x 25 - base 20 x 20



-Art. 3273 ■■
h. 83 x 32
base Ø 23



Art. 3036 ■■
h. 60 x 30
base Ø 12

Art. 3038 ■■
h. 105 x 42 - base Ø 26



Art. 3442 ■■
h. 93 x 37 x 20



Art. 3063 ■■
h. 110 x 32
base 31 x 26



-Art. 3280 ■■
h. 55 x 15
base 13 x 22

-Art. 3282 ■■
h. 78 x 22
base 18 x 17



Art. 3204 ■■
h. 91 x 28
base 17 x 14



Art. 3333 ■■
h. 81 x 47



-Art. 3338 ■■
h. 63 x 25
base 15 x 14



-Art. 3347 ■■
h. 65 x 37
base Ø 21



Madonna delle Grazie

■ **Art. 3449** ■
h. 26

■ **Art. 3340** ■
h. 26

Madonna del Carmelo

■ **Art. 3376** ■
h. 80 - base 20,5 x 20,5

■ **Art. 3403** ■
h. 128 - base 29 x 27



Madonna del Carmelo

■ **Art. 3375** ■
h. 47 - base 13 x 12



■ **Art. 3353** ■
h. 73 - base Ø 22

■ **Art. 3410** ■ **senza corona**
h. 70 - base Ø 22



Madonna del Tindari

■ **Art. 3329** ■
h. 65 - base 24 x 24



Madonna di Fatima

■ **-Art. 3445** ■
h. 70 x 21 x 16 - base Ø 13,5

■ **-Art. 3446** ■ **senza corona**
h. 62 x 21 x 16 - base Ø 13,5



Art. 3342 ■■
h. 81 x 25
base Ø 22



-Art. 3303 ■■
h. 83 x 25
base 15 x 13



-Art. 3319 ■■
h. 71 x 20



Art. 3410 ■■
h. 70 - base Ø 22



-Art. 3170 ■■
h. 58
base Ø 11

con corona
vedi art. 3353



-Art. 3334 ■■
h. 60 x 24
base 16 x 17



-Art. 3144 ■■
h. 60 x 16 - base 10 x 11



Art. 3378 ■■
h. 60
base 19 x 18



Art. 3235 ■■
h. 53 x 14
base Ø 12

-Art. 3169 ■■
h. 84 - base 17 x 15



Art. 3444 ■■
h. 103 x 35 x 17



Art. 3443 ■■
h. 90 x 32 x 21



Art. 3371 ■■
h. 93 x 40
base Ø 22



Art. 3409 ■■
h. 91 x 26
base 24 x 21



Art. 3356 ■■
h. 86 x 30
base Ø 20



Art. 3447 ■■
h. 56 x 23



Art. 3395 ■■
h. 82 x 28
base 20 x 17



 -Art. 3284 ■■
h. 82 - base 18 x 16



 -Art. 3288 ■■
h. 77 - base 15 x 16



Art. 304701 ■■
h. 95 - base 27 x 21



Art. 3457 ■■
h. 64 x 28



Art. 3435 ■■
h. 60 x 17 x 11



 -Art. 3043 ■■
h. 62 x 15
base 13 x 12



 -Art. 3173 ■■
h. 63
base 13 x 13



-Art. 3093 ■■
h. 60 - base 11 x 9



Art. 3042 ■■
h. 56 x 14
base Ø 13

-Art. 3054 ■■
h. 76 - base 15 x 12



 -Art. 3372 ■■
h. 82 x 20 - base Ø 19



Madonna di Lourdes

Art. 3035 ■■
h. 112 x 29
base 27 x 25



Art. 3233 ■■
h. 111 x 30
base 21 x 28



Madonna dei poveri

Art. 3047 ■■
h. 100 x 29
base 27 x 21



 -Art. 3290 ■■
h. 88 x 23
base 15 x 19



 -Art. 3269 ■■
h. 84 x 23
base Ø 20



Madonna di Lourdes

Art. 3079 ■■
h. 83 x 28
base Ø 21



 -Art. 3330 ■■
h. 64 x 16
base 14 x 14



 -Art. 3179 ■■
h. 93 x 40
base Ø 22



 -Art. 3304 ■■
h. 83 x 25
base 15 x 13



 -Art. 3154 ■■
h. 85 x 31
base Ø 20



Art. 3359SA ■■
h. 69 - base 20 x 20



 -Art. 3451SA ■■
h. 47 x 18 x 23,5
base 17 x 15



Art. 3399 ■■
h. 82 x 28
base 20 x 17



 -Art. 3429 ■■
h. 58
base Ø 11



 -Art. 3255 ■■
h. 56 x 13
base 9 x 8



Art. 3455 ■■
h. 20 x 10
base Ø 5

Art. 3398 ■■
h. 38 x 17
base Ø 8,5



 -Art. 3260 ■■
h. 31,5 x 7
base Ø 6



 -Art. 3251 ■■
h. 22,5
base Ø 4,5

Art. 3397 ■■
h. 27 x 12
base Ø 7 x 6

Art. 3405 ■■
h. 48 x 20
base Ø 11,5



Art. 3497 ■■
h. 21 x 10
base Ø 5

Art. 3374 ■■
h. 42 x 17
base Ø 8,5



 -Art. 3306 ■■
h. 36 x 14
base Ø 9,5



 -Art. 3262 ■■
h. 31
base Ø 6



 -Art. 3318 ■■
h. 39 x 10
base Ø 7



 -Art. 328840 ■■
h. 38,5 x 9,5 x 7
base 8 x 6,5

Art. 3336 ■■
h. 29 x 12
base 7 x 6

Art. 3498 ■■
h. 53 x 20
base Ø 11,5



Art. 3110 ■■
h. 153



Art. 3006 ■■
h. 162 x 43
base 35 x 35



Art. 3007 ■■
h. 163 x 38
base 30 x 30



Art. 3111 ■■
h. 159
base 45 x 41



Donna con bambino
Art. 3482 ■■
h. 178 x 54 x 50
base 47 x 40



Art. 3114 ■■
h. 143 x 50
base 35 x 37



Art. 3004 ■■
h. 90 x 74 x 62



Art. 3285 ■■
h. 70 x 42 base 32 x 40



Art. 3368 ■■
h. 110 - base 40 x 54 R/95



Art. 3426 ■■
h. 140 x 54 x 81



Art. 3096 ■■
h. 80 - base 52 x 65



Art. 3419 ■■
h. 59 x 22 x 37

Art. 3028 ■■
h. 80 x 29 - base 25 x 55
Realizzabile con manto liscio.
Chiedere preventivo.



Art. 3136 ■■
h. 95 base 40 x 50



Art. 3166 ■■
h. 65 - base 59 x 36



Art. 3172 ■■
h. 59 base 20 x 16



-Art. 3360 ■■
h. 56 x 31 base 29 x 18



-Art. 3394 ■■
h. 45 x 17 x 28



Art. 3125 ■■
h. 42 base 18 x 25



S. Teresa

Art. 3475 ■■
h. 182
base 51 x 51



Art. 3332 ■■
h. 100 - base 59 x 49



S. Barbara

Art. 3424 ■■
h. 35 x 14



S. Rita da Cascia

Art. 3001 ■■
h. 60 x 22 base 13 x 14



S. Rita da Cascia

Art. 3087 ■■
h. 155 x 54 base 45 x 40



Art. 3496 ■■
h. 77 x 50 x 40



Vescovo Scalabrini

Art. 3493P ■■
h. 178 x 62 x 45
base 53 x 44

patina verde pompeiano

Art. 3493 ■■
h. 178 x 62 x 45
base 53 x 44

patina classica



Sacra Famiglia

Art. 3175 ■■
h. 104 x 50 x 50



San Domenico

Art. 3139 ■■
h. 180 x 106
base 46 x 42



S. Gerardo

Art. 399032 ■■
h. 83
base 18 x 18



S. Cristoforo

Art. 3450 ■■
h. 56
base 24 x 19



S. Francesco

Art. 313901 ■■
h. 180 x 106
base 46 x 42



San Francesco

Art. 3240 ■■
h. 188 x 75
base 48 x 42



S. Antonio

Art. 388001 ■■
h. 180



San Francesco

Art. 3317 ■■
h. 81 x 41
base 25 x 24



San Francesco

Art. 3473 ■■
h. 51 x 36, 5 x 14
base 12 x 14



S. Giuseppe

Art. 3492 ■■
h. 80



S. Antonio
Art. 3032 ■■
h. 158
base 50 x 40



S. Antonio
Art. 3031 ■■
h. 118
base 35 x 27



S. Antonio
Art. 3030 ■■
h. 80 x 26
base 24 x 20



S. Antonio
Art. 303001 ■■
h. 72 x 26 x 23,5



S. Antonio
Art. 3401 ■■
h. 30
base 6 x 6



S. Antonio
Art. 3402 ■■
h. 38
base 8,5 x 8,5



S. Antonio
Art. 3357 ■■
h. 62
base 18 x 18



S. Giuseppe
Art. 3358 ■■
h. 62
base 18 x 18



S. Giuseppe
Art. 3437 ■■
h. 41
base 15 x 12

Art. 3029 ■■
h. 60 x 20
base 18 x 14



San Tommaso

Art. 399034 ■■
h. 122
base Ø 27



San Gabriele

Art. 399035 ■■
h. 122
base Ø 27



San Luca

Art. 399036 ■■
h. 122
base Ø 27



San Giuseppe

Art. 399037 ■■
h. 122
base Ø 27



San Luigi

Art. 399039 ■■
h. 127
base Ø 27



San Patrizio

Art. 399038 ■■
h. 137
base Ø 27



Papa Giovanni Paolo II



Busto
Art. 3015 ■■
h. 50 base 52 x 43
patina classica

Art. 301401M ■■
h. 188 base 63 x 63

patina artistica

Art. 301401P ■■

patina verde pompeiano

Art. 301401 ■■

patina classica



"scultura
patinata
artistica"



Art. 345802 ■■
h. 63 base 15 x 16

patina classica

Art. 345802P ■■

patina verde pompeiano



Papa G. Paolo II

Art. 349140 ■■
h. 40 - base 9 x 9

Art. 349160 ■■
h. 60 - base 14 x 14



Art. 345801P ■■
h. 58 base 15 x 16

patina verde
pompeiano

Art. 345801 ■■

patina classica

Papa Giovanni Paolo II



Art. 3000BZ ■■
h. 215 x 107 x 60



Art. 301402 ■■
h. 193 base 64 x 64

patina classica

Art. 301402P ■■

patina verde pompeiano

Art. 301402M ■■

patina artistica



“scultura
patinata
verde
pompeiano”





Papa Giovanni XXIII

Art. 3454 ■■
h. 171 - base 50 x 46



Papa Giovanni XXIII

Art. 3421 ■■
h. 60 - base 18 x 18

Art. 3422 ■■
h. 86 - base 34 x 24



Padre Pio

Art. 3373 ■■
h. 40,5 x 16
base 13 x 12



Padre Pio

Art. 3343 ■■ h. 100 x 45 x 35
base 30 x 30



Padre Pio

Art. 3408 ■■
h. 178,5 - base 54 x 52

patina artistica





 -Art. 3051 ■■
h. 43 x 34 base 19 x 17



 -Art. 3387 ■■
h. 40 x 36 - base 24 x 17



 Art. 3012 ■■
h. 43 x 26 - base 25 x 20



 Art. 3057 ■■
h. 30 x 28 base 20 x 15



 Art. 3059 ■■
h. 30 x 26 - base 20 x 15



Giovanni Paolo II

 Art. 3361 ■■
h. 21 x 15 base 10 x 15



Padre Pio

 Art. 3425 ■■
h. 60 x 49 x 44



 Art. 3084 ■■
h. 23 - base 25 x 15



 Art. 3323 ■■
h. 39 x 35 - base 36 x 18



Art. 3228 ■■
h. 190 x 84 - base 36 x 50



Art. 3103 ■■
h. 160 x 80 - base 29 x 54



Art. 3275 ■■
h. 104 x 80 x 24
base 28 x 18



Art. 3258 ■■
h. 104 x 40
base 21 x 22



Art. 399029 ■■
h. 34 x 41 x 15



Art. 399024 ■■
h. 39 x 16,5 x 18



Art. 399025 ■■
h. 44 x 38 x 18



Art. 399026 ■■
h. 56 x 31 x 20

Art. 399028 ■■
h. 43,5 x 21 x 12



Art. 399028P ■■
h. 43,5 x 21 x 12



Art. 399031 ■■
h. 200 x 90 x 125
base 50 x 50



Art. 399027 ■■
h. 184 x 115 x 111
base 53 x 50

Versione in acciaio **Art. 099001** p. 390



Art. 399033/D ■■
h. 132,5 x 53 x 104
base Ø 28



Art. 399033/S ■■
h. 132,5 x 53 x 104
base Ø 28



Art. 3462/S ■■
h. 25 x 17 x 12



Art. 3462/D ■■
h. 25 x 17 x 12



Art. 3386 ■■
h. 50 - base 10 x 10



-Art. 3451 ■■
h. 60 x 30 x 20
base 17 x 15



Art. 3052 ■■
h. 40
base 12 x 20



Art. 3050 ■■
h. 80 x 45 x 32
base 27 x 20

Art. 3359 ■■
h. 82 x 33 x 36
base 21 x 21,5



Art. 3389 ■■
h. 66,5
base 18 x 16,5



-Art. 3448 ■■
h. 58 x 23
base 19 x 17



Art. 3391 ■■
h. 40 x 19
base 11 x 11



Art. 3390 ■■
h. 31 x 14
base 7,5 x 7,2



■ Art. 3490 ■■
h. 9 x 15,5 x 9,5



■ Art. 3490/S ■■
h. 5,5 x 9 x 3,5



■ Art. 3488 ■■
h. 9 x 15,5 x 9,5



■ Art. 3489 ■■
h. 11 x 9 x 9



■ Art. 3476 ■■
h. 16,7 x 10 x 8



■ Art. 3480 ■■
h. 8 x 10 x 5



■ Art. 3477 ■■
h. 14 x 9,5 x 10



■ Art. 3470 ■■
h. 12,5 x 10,6 x 10



■ Art. 3467 ■■
h. 12,5 x 10,6 x 9,5



■ Art. 3478 ■■
h. 12,5 x 10,6 x 9



-Art. 3432 ■■
 h. 130 - Ø inferiore 65
 Ø superiore 145
 n. 63 colombe



Angelo con Ali
-Art. 3302 ■■
 h. 96 x 50 - base 20 x 20



Angelo senza Ali
-Art. 3276 ■■
 h. 83 x 26 - base 20 x 20

-Art. 3354 ■■
 h. 96 x 50 - base 43 x 30



-Art. 3469 ■■
h. 5,5 x 8



-Art. 346802 ■■
h. 3,5 x 7,5



-Art. 346804 ■■
h. 3,5 x 8,5



-Art. 346801 ■■
h. 4,5 x 7,5



-Art. 3270 ■■
h. 6,5 x 10 x 5,5



Art. 3411
h. 3,5 x 6 x 3



Art. 3412
h. 3,5 x 9 x 4



Art. 346301 ■■
h. 4,6



Art. 346302 ■■
h. 4,9



Art. 346303 ■■
h. 4,3



Art. 346304 ■■
h. 5,3



Art. 346401 ■■
h. 7,5 cm



Art. 346403 ■■
h. 6,5 cm



Art. 346404 ■■
h. 9 cm



Disponibili su richiesta in versione dorata, argentata e ramata. Chiedere preventivo.



■ Art. 1066
h. 10 x 8

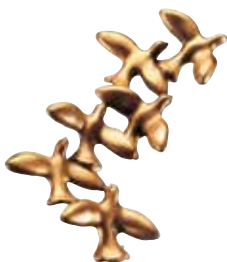

■ Art. 106603
h. 7 x 8 x 10



■ Art. 106606
h. 11 x 8 x 11

■ Art. 106605
h. 12 x 17 x 13

■ Art. 106604
h. 12 x 17 x 13



■ -Art. 3287 ■■
h. 82 x 40 x 36



■ -Art. 3234 ■■
h. 87 x 70 x 50



■ -Art. 3246 ■■
h. 72 x 54 - base 11 x 20



■ -Art. 3242 ■■
h. 41 x 54 x 45



■ -Art. 3241 ■■
h. 66 x 60 x 44



Art. 3020 ■■
h. 29 x 60 x 22

Art. 3016 ■■
h. 42 x 105 x 24

Art. 3021 ■■
h. 55 x 115 x 54



Art. 3259 ■■
h. 85 x 152
base 26 x 20



-Art. 3245 ■■
h. 10 x 25 x 23



-Art. 3243 ■■
h. 5,5 x 34 x 26



-Art. 3244 ■■
h. 16 x 25 x 25



Art. 106602
h. 4 x 9 x 8



Art. 106601
h. 3 x 11 x 8



Art. 3453/FP ■■
h. 19



Art. 3453/MP ■■
h. 21



Art. 3453/F ■■
h. 19



Art. 3453/M ■■
h. 21



Art. 3301 ■■
h. 16 x 20 x 13



Art. 3181 ■■
h. 40 x 42 x 23



Art. 3495 ■■
L 68 - Apertura Ali 63



Art. 3328 ■■
h. 17 x 14 x 10



S. Giorgio

Art. 3316 ■■
h. 63 x 66 - base 57 x 25



Art. 3176 ■■
h. 80 x 45 x 81

Art. 3327 ■■
h. 116 x 66 x 106



-Art. 1184 ■■
h. 22 x 25 x 20



Art. 1187
h. 7,5 x 9 x 7,5



-Art. 3291 ■■
h. 15 x 22 x 30

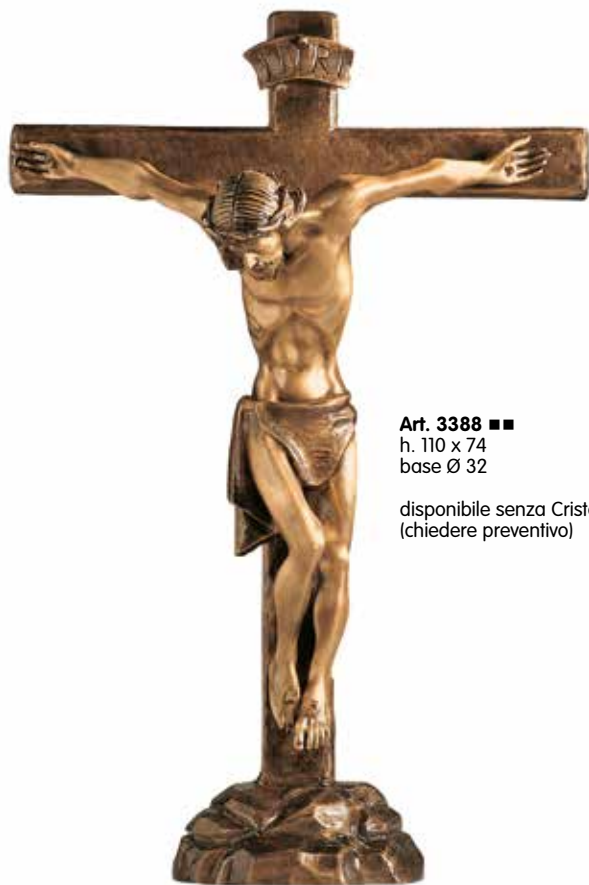

Art. 3388 ■■

h. 110 x 74

base Ø 32

disponibile senza Cristo
(chiedere preventivo)



Art. 3044 ■■

h. 103,5 x 52,5

base 29 x 15

(sezione L)

Chiusura dietro
(chiedere preventivo)



-Art. 3098 ■■
h. 110 x 59 - base 35 x 10
(compreso corsivo saldato)



-Art. 3118 ■■
h. 110 x 47 - base 38 x 10



-Art. 3222 ■■
h. 90 x Ø 63 - base 18 x 22



-Art. 3250 ■■
h. 90 x Ø 63 base 18 x 22

Cubic System

FINITURA CUBIC MARMORIZZATA

La finitura Cubic marmorizzata si ottiene attraverso bagno ad immersione. Il pezzo in bronzo viene ricoperto da una speciale vernice a 200 gradi che farà da supporto alla fase successiva di cubicatura. Attraverso l'immersione del pezzo in una speciale vasca contenente il prodotto marmorizzante, si ottiene una perfetta adesione alla superficie del materiale immerso. Si possono ottenere diverse colorazioni o tipi di marmo, a scelta tra Botticino, Verde Alpi e Bianco Carrara. Tale lavorazione, detta cubicatura, è utilizzata dalla ditta Biondan sin dai primi anni '90, con ottimi risultati e soddisfazione della clientela. Si tratta di un brevetto giapponese - nato per il settore automobilistico e poi ampiamente diffuso in vari settori - sul quale la ditta Biondan gode di un'esclusiva per il settore funerario. Su tale prodotto, data l'altissima affidabilità e durata del trattamento, è stata applicata una garanzia di 8 anni sulla corrosione.

CUBIC MARBLED FINISH

Cubic marbled finish is produced by dipping. Bronze pieces are covered in a special paint at 200 degrees which will act as a support for the following cubing stage. The piece is dipped into a special tank containing the marbling product to ensure perfect adhesion to the surface of the dipped material. Different colours or types of marble can be produced, and clients can choose from Botticino, Verde Alpi or Bianco Carrara. Said processing technique is called cubing, and has been used by Biondan since the early 90s, with excellent results and client satisfaction. It carries a Japanese patent, initially developed for the automobile sector but then extended to many others. Biondan enjoys the exclusive right to use the technique for the funerary sector. An 8 year warranty against corrosion is applied to this product, given the reliability and long-lasting features of the treatment.



LED LIGHT SOLUTION
AETERNUM

CANDELE CON EFFETTO FIAMMA VERA



Candele Led a lunga durata.
Senza cera, non producono fumo,
non riscaldano, non sporcano.



Ogni articolo contiene:

- Candela AETERNUM con Led movimento a fiamma
- 2 pile Alkaline
- Istruzioni

■ ■ Art. 5100
h. 15 x 8

■ ■ Art. 510002
h. 10,5 x 6,5

■ ■ Art. 510003
h. 8 x 3,5



BIONDAN
0123456789

Art. 764015K - h. 1,5
Art. 764020K - h. 2
Art. 764025K - h. 2,5
Art. 764030K - h. 3
Art. 764040K - h. 4
Art. 764050K - h. 5
Art. 764060K - h. 6
Art. 764080K - h. 8
Art. 764099K - h. 10
Art. 764000K - segni

◆ Focus traforato
verde alpi

Biondan
0123456789

Art. 762015K - h. 1,5
Art. 762020K - h. 2
Art. 762025K - h. 2,5
Art. 762030K - h. 3
Art. 762040K - h. 4
Art. 762050K - h. 5
Art. 762060K - h. 6
Art. 762080K - h. 8
Art. 762099K - h. 10
Art. 762000K - segni

◆ Modus traforato

Biondan
0123456789

Art. 763015K - h. 1,5
Art. 763020K - h. 2
Art. 763025K - h. 2,5
Art. 763030K - h. 3
Art. 763040K - h. 4
Art. 763050K - h. 5
Art. 763060K - h. 6
Art. 763080K - h. 8
Art. 763099K - h. 10
Art. 763000K - segni

◆ Romano corsivo traforato

BIONDAN
0123456789

Art. 761015K - h. 1,5
Art. 761020K - h. 2
Art. 761025K - h. 2,5
Art. 761030K - h. 3
Art. 761040K - h. 4
Art. 761050K - h. 5
Art. 761060K - h. 6
Art. 761080K - h. 8
Art. 761099K - h. 10
Art. 761000K - segni

◆ Avant traforato

Nelle ordinazioni indicare sempre l'altezza della vocale minuscola. Il prezzo verrà calcolato in base all'altezza della vocale minuscola.

A richiesta si forniscono numeri sciolti: uguale prezzo. Spessore mm 3. Per spessore superiore a mm 3 chiedere preventivo.

The height of the small letters must always be mentioned on the order. The price will be calculated on this basis.

Loose numbers (not on a bar) are available upon request at same price. Thickness 3 mm. For extra thickness please ask for a quote.

Aa Bb Cc Dd Ee Ff Gg

Hh Ii Jj Kk Ll Mm Nn

Oo Pp Qq Rr Ss Tt Uu Vv

Ww Xx Yy Zz Ll

a b c d e f g h i j k l m n o p

q r s t u v w x y z l

0 1 2 3 4 5 6 7 8 9 n m A Ω * * †

66 33 68 70 67

Iniziale minuscola



77



77 60 61 76 64 63 62

1 2 3 4 5 6 7 8 9 0

n m A Ω * * †

66 33 68 70 67



Art. 7421K

cm. 10 - max 4 alloggi

Art. 7422K

cm. 17 - max 6 alloggi

Art. 7423K

cm. 27 - max 10 alloggi

Art. 7424K

cm. 29,5 - max 11 alloggi

Art. 7425K

cm. 32 - max 12 alloggi

Per esempi di composizione delle barrette e misure d'ingombro vedi pag. 2-3 (bronzo).

Per quantità inferiori alla confezione e forniture di diciture, aumento del 20%.
20% surcharge for any order less than the minimum requirement and for specific words.



Sistema di montaggio

Art. 7385 h. 6
maiuscole

Art. 7386 h. 2,7
minuscole

Art. 7387 h. 2,7
lettere terminali

Art. 7388 h. 2,7
Numeri e lettere
con perni

Art. 7393
segni

Art. 7389 - h. 2,7
Numeri e lettere
avvitabili su barretta

Biondan

2008

◆ Art. 7626K - h. 6 - 2,7

◆ Art. 7826K - h. 8 - 4



Art. 7366K - h. 6 - 2,7

Art. 7477K - h. 8 - 4



Art. 7589 - h. 1,5
●**x.ÆPDLØ

Art. 7148 - h. 2,5
●**x.ÆPDLØ

Art. 7150 - h. 3
●**x.ÆPDLØ

Art. 7149 - h. 4
●.ÆPDLØ

Art. 7151 - h. 5
●.ÆPDLØ

Art. 7152 - segni

Per quantità inferiori alla confezione e forniture di dicitore, aumento del 20% .

Legenda simboli: ● Lettere / * Numeri / x Stelle - Croci - Æ (65) - P(59) - D (71) - L (72) - Ø (73)

20% surcharge for any order less than the minimum requirement and for specific words.

Symbols: ● Letters / * Figures / x Stars - Crosses - Æ (65) - P(59) - D (71) - L (72) - Ø (73)



Art. 7313K - h. 1,5

Art. 7316K - h. 3

Art. 7319K - h. 6

Art. 7314K - h. 2

Art. 7317K - h. 4

Art. 7320K - h. 8

Art. 7315K - h. 2,5

Art. 7318K - h. 5

Art. 7321K - h. 10

Art. 7325K - segni

Nelle ordinazioni indicare sempre l'altezza della vocale minuscola. Il prezzo verrà calcolato in base all'altezza della vocale minuscola.

A richiesta si forniscono numeri sciolti: uguale prezzo. Spessore mm 3. Per spessore superiore a mm 3 chiedere preventivo.

The height of the small letters must always be mentioned on the order. The price will be calculated on this basis.

Loose numbers (not on a bar) are available upon request at same price. Thickness 3 mm. For extra thickness please ask for a quote.

A B C D E F G H K I J L M
a b c d e f g h k i j l m

Art. 7290K - h. 1,5

Art. 7293K - h. 3

Art. 7296K - h. 6

Art. 7291K - h. 2

Art. 7294K - h. 4

Art. 7297K - h. 8

Art. 7292K - h. 2,5

Art. 7295K - h. 5

Art. 7298K - h. 10

Art. 7299K - segni

Nelle ordinazioni indicare sempre l'altezza della vocale minuscola. Il prezzo verrà calcolato in base all'altezza della vocale minuscola.

A richiesta si forniscono numeri sciolti: uguale prezzo. Spessore mm 3. Per spessore superiore a mm 3 chiedere preventivo.

The height of the small letters must always be mentioned on the order. The price will be calculated on this basis.

Loose numbers (not on a bar) are available upon request at same price. Thickness 3 mm. For extra thickness please ask for a quote.

Art. 2724K - h. 5 - 2,5

Art. 2455K - h. 8 - 4

Art. 2723K - h. 2,5
numeri M N *+
vocali sciolte

Art. 2877K - h. 4
numeri M N *+
vocali sciolte

Art. 2057K - h. 2,5
segni

Art. 2888K - h. 4
segni

Carquino
Valsazzina

1 2 3 4 5 6 7 8 9 0

a i o m n e u

+ ★ ∨ ∩ ∙ ~

67 70 76 62 63 61 64

m 11 3 1988

CARATTERI DISPONIBILI PER INCISIONE

TIPO	
"CD"	<i>Abcdef</i>
"BM"	ABCDEFGFG
"BL"	ABCDEF
"BS"	ABCDEFGH



Esempio

Art. 2520

Prezzo a forfait per cognome, nome e date

CHIAVARDE PORTANTI per spessore marmo da mm 18 a mm 22 - con perno 8 MA inox V/91F **incluso nel prezzo**



Art. 2911K
mm. 44



Art. 2910K
mm. 60

Art. 2908K
mm. 80

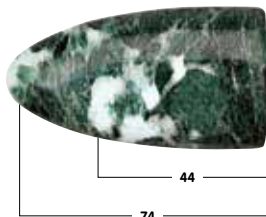

Art. 2915K
mm. 44

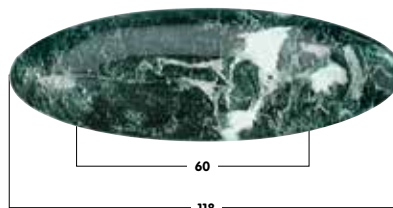

Art. 2914K
mm. 60



Art. 1159K
h. 2,5

Art. 1148K
h. 4

Art. 1146K
h. 3

***Art. 1149K**
h. 5



***Art. 1239K**
Ø 4

Le borchie vengono fornite con perno V/01 da mm. 50 passo 5 MA, salvo diversa descrizione. In caso di sostituzione del perno, quello in dotazione verrà valutato al prezzo di listino.

* A richiesta possono essere fornite con perno fino a 10 MA.



Art. 1520K
h. 10 x 15

Art. 1523K
h. 11 x 20

Art. 1524K
h. 14 x 23

Art. 1528K
h. 16 x 27

Art. 2905K
h. 5,5 x 12

Art. 1519K
h. 7 x 10



Art. 2976K
h. 13 x 23
cornice massima applicabile 7 x 9

Art. 2978K
h. 18 x 29
cornice massima applicabile 9 x 12



Art. 2693K
h. 16 x 24



Art. 2977K
h. 13 x 23
cornice massima applicabile 7 x 9

Art. 2979K
h. 18 x 29
cornice massima applicabile 9 x 12



Art. 2909K
h. 17 x 25
base 12 x 8



Art. 1492K
h. 28 x 36,5
cornice massima applicabile 11 x 15

Art. 7051K
h. 25,5 x 36 x 24
cornice massima applicabile 11 x 15

Tipo "CD" *Abode* Tipo "BM" ABCDEFG Tipo "BL" ABCDEF Tipo "BS" ABCDEFGH

Incisione gratuita
Free engraving

PREZZO ESCLUSO CORNICE
PRICE DOES NOT INCLUDE FRAME

Serie Orum



Art. 7111K
8 x 10

Art. 7112K
9 x 12

Art. 7113K
11 x 15



Art. 7115K
9 x 12

Art. 7116K
10 x 15

Art. 7098K
11 x 15

Serie Universale



Art. 1449K
7 x 9

Art. 1450K
8 x 10

Art. 1451K
9 x 12

Art. 1452K
11 x 15



Art. 297407K
7 x 9

Art. 2974K
8 x 10

Art. 2980K
9 x 12

Art. 2981K
10 x 15



■ Art. 7033K
9 x 12

Art. 7034K
11 x 15



■ Art. 7024K
9 x 12

Art. 7025K
10 x 15



■ Art. 7062K
9 x 12

Art. 7063K
11 x 15



■ Art. 7016K
9 x 12

Art. 7017K
10 x 15



■ Art. 2945KU
9 x 12

Art. 2946KU
11 x 15

Art. 2992KU
13 x 18



■ Art. 2949KU
9 x 12

Art. 2948KU
10 x 15

Art. 7055KU
13 x 18



■ Art. 2955KU
9 x 12

Art. 2956KU
11 x 15

Art. 7080KU
13 x 18



■ Art. 2959KU
9 x 12

Art. 2960KU
10 x 15

Art. 7081KU
13 x 18



■ Art. 2078K
7 x 9

Art. 2075K
8 x 10

Art. 2076K
9 x 12

Art. 2077K
11 x 15

Art. 2094K
13 x 18

Art. 2095K
18 x 24



■ Art. 138107K
7 x 9

Art. 1381K
9 x 12

Art. 1382K
10 x 15

Art. 1378K
11 x 15

Art. 1377K
13 x 18



■ Art. 2955K
9 x 12

Art. 2956K
11 x 15

Art. 7080K
13 x 18

Art. 7180K
18 x 24



■ Art. 2959K
9 x 12

Art. 2960K
10 x 15

Art. 7081K
13 x 18



Art. 7410KP
h. 20,5 x 13 x 14
P/72-CK

Art. 7543KP
h. 20,5 x 13
P/72-CK

Art. 7409KP
h. 30,5 x 18
P/29**K



Art. 7417K
h. 20,5 x 9,5 x 10
F/12

Art. 7488K
h. 20,5 x 9,5 x 10
F/12



Art. 7408KP
h. 19 x 20 x 15
P/A14**K

Art. 7483KP
h. 19 x 20
P/A14**K



Art. 733713KP (ossario)
h. 13,5 x 7 x 7,5 P/50

Art. 7337KP
h. 20 x 11 x 11,5 P/83

Art. 734413KP (ossario)
h. 13,5 x 7 P/50

Art. 7344KP
h. 20 x 11 P/83

Art. 734430KP
h. 30 x 16 P/2901



Art. 733914K (ossario)
h. 14 x 8 x 8,5 F/01

Art. 7339K
h. 19 x 10 x 10,5 F/12

Art. 734514K (ossario)
h. 14 x 8 F/01

Art. 7345K
h. 19 x 10 F/12

Art. 734523K
h. 23 x 10,5 F/03



Art. 7336KP
h. 18,5 x 16 x 16,5 P/A10

Art. 7348KP
h. 18,5 x 16 P/A10



Art. 7259KP new
h. 19,5 x 19 x 12,5 P/A3K

Art. 7259KR
h. 19,5 x 19 x 12,5 R/A3K

Art. 7260KP new
h. 19,5 x 19 x 12,5 P/A3K

Art. 7260KR
h. 19,5 x 19 x 12,5 R/A3K



Art. 7181KR
h. 10 x 10 x 9 R/01

Art. 7182KR
h. 10 x 10 x 9 R/01

Art. 7183KR
h. 13 x 11 x 11 R/B4



Art. 7261K
h. 22 x 14 x 13 M/41-8

Art. 7262K
h. 22 x 14 x 12 M/41-8



Art. 1439K
Ø 6 F/01

Art. 1441K
Ø 8 F/03

Art. 1440K
Ø 7 F/02

Art. 1442K
Ø 11 F/04



Art. 7256K
h. 21 x 10 x 9 F/12

Art. 7257K
h. 21 x 10 x 9 F/12

Art. 7258K
h. 25 x 11 x 11 F/03



Art. 7253KP new
h. 20 x 13 x 12 P/83

Art. 7253KR
h. 20 x 13 x 12 R/93-AK

Art. 7254KP new
h. 20 x 13 x 11 P/83

Art. 7254KR
h. 20 x 13 x 11 R/93-AK

Art. 7255KP new
h. 31 x 17,5 x 16 P/29**K

Art. 7255KR
h. 31 x 17,5 x 16 R/B3K



Art. 7033K
9 x 12

Art. 7034K
11 x 15



Art. 7024K
9 x 12

Art. 7025K
10 x 15



Art. 7062K
9 x 12

Art. 7063K
11 x 15



Art. 7016K
9 x 12

Art. 7017K
10 x 15



Art. 7302KP new
h. 20,5 x 12 P/83

Art. 7302KR
h. 20,5 x 12 R/93-AK

Art. 7308KP new
h. 20,5 x 12 P/83

Art. 7308KR
h. 20,5 x 12 R/93-AK

Art. 7303KP new
h. 29 x 15,5 P/68

Art. 7303KR
h. 29 x 15,5 R/88-DK



Art. 7304K
h. 20 x 10 F/12

Art. 7309K
h. 20 x 10 F/12

Art. 7323K
h. 25 x 11 F/03



Art. 7305KP new
h. 19 x 16 x 11 P/A3K

Art. 7305KR
h. 19 x 16 x 11 R/77**K

Art. 7310KP new
h. 19 x 16 x 11 P/A3K

Art. 7310KR
h. 19 x 16 x 11 R/77**K



Art. 7431KP (ossario)
h. 12 x 6 x 6,5 P/43**K

Art. 7432KP (ossario)
h. 12 x 6 P/43**K

Art. 7119KP new
h. 18 x 18 x 13 P/A3K

Art. 7117K
h. 23 x 14 M/41-8

Art. 7106KR
h. 20 x 12 R/97K

Art. 7107KR
h. 20 x 12 R/97K

Art. 7119KR
h. 18 x 18 x 13 R/A3K

Art. 7118K
h. 23 x 14 M/41-8

Art. 7106KP
h. 20 x 12 P/92-AK

Art. 7107KP
h. 20 x 12 P/92-AK

Art. 7120KP new
h. 18 x 18 x 13 P/A3K

Art. 7108KR
h. 30 x 18 R/B3K

Art. 7120KR
h. 18 x 18 x 13 R/A3K

Art. 7108KP
h. 30 x 18 P/29**K



Art. 7433K (ossario)
h. 14 x 6 x 7 F/01

Art. 7109K
h. 20 x 10 F/12

Art. 7434K (ossario)
h. 14 x 6 F/01



Art. 7111K
8 x 10

Art. 7112K
9 x 12

Art. 7113K
11 x 15



Art. 7115K
9 x 12

Art. 7116K
10 x 15

Art. 7098K
11 x 15

Art. 7110K
h. 20 x 10 F/12



Art. 7327KP new
h. 20,5 x 12 x 12,5
P/83

Art. 7327KR
h. 20,5 x 12 x 12,5
R/93-AK



Art. 7330KP new
h. 20,5 x 12
P/83

Art. 7330KR
h. 20,5 x 12
R/93-AK



Art. 7328K
h. 20 x 10 x 10,5
F/12

Art. 7331K
h. 20 x 10
F/12

Art. 7326KP new
h. 19 x 16 x 11,5
P/A3K

Art. 7326KR
h. 19 x 16 x 11,5
R/77**K

Art. 7329KP new
h. 19 x 16 x 11
P/A3K

Art. 7329KR
h. 19 x 16 x 11
R/77**K

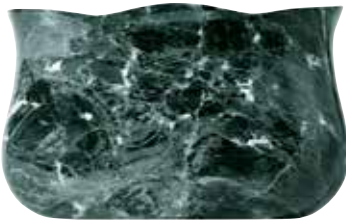

Art. 7324KP
h. 17 x 27 x 11
P/A74K

(sezione ☺)



Art. 7391KP
h. 12,6 x 4,3
P/A13

(sezione ☺)

Serie Decò



Art. 7087KP (ossario)
h. 14 x 9 x 9 P/50

Art. 2982KP new
h. 21 x 13 x 11 P/72

Art. 2982KR
h. 21 x 13 x 11 R/93

Art. 7089KP (ossario)
h. 14 x 9 P/50

Art. 2969KP new
h. 21 x 13 P/72

Art. 2969KR
h. 21 x 13 R/93

Art. 2996KP new
h. 29 x 17 P/59-DK

Art. 2996KR
h. 29 x 17 R/88-DK



Art. 7086K (ossario)
h. 15 x 8 x 8 F/01

Art. 2983K
h. 20 x 10 x 11 F/02

Art. 7088K (ossario)
h. 15 x 8 F/01

Art. 2970K
h. 20 x 10 F/02

Art. 2997K
h. 25 x 12 F/03



Art. 2984K
h. 23 x 14 x 14 M/41-8

Art. 2971K
h. 23 x 14 M/41-8

Art. 29Y9K
h. 26 x 17 M/57



Art. 2985KP new
h. 18 x 20 x 15 P/70**K

Art. 2985KR
h. 18 x 20 x 15 R/77**K

Art. 2958KP new
h. 18 x 20 P/70**K

Art. 2958KR
h. 18 x 20 R/77**K

Serie Alliance



Art. 2982KPU new
h. 21 x 13 x 11 P/72

Art. 2982KRU
h. 21 x 13 x 11 R/93

Art. 2969KPU new
h. 21 x 13 P/72



Art. 2969KRU
h. 21 x 13 R/93

Art. 2996KPU new
h. 29 x 17 P/59-DK

Art. 2996KRU
h. 29 x 17 R/88-DK



Art. 2984KU
h. 23 x 14 x 14 M/41-8

Art. 2971KU
h. 23 x 14 M/41-8

Art. 2997KU
h. 25 x 12 F/03



Art. 2985KPU new
h. 18 x 20 x 15 P/70**K

Art. 2985KRU
h. 18 x 20 x 15 R/77**K



Art. 2958KPU new
h. 18 x 20 P/70**K

Art. 2958KRU
h. 18 x 20 R/77**K



Art. 2945KU
9 x 12

Art. 2946KU
11 x 15

Art. 2992KU
13 x 18

Art. 2949KU
9 x 12

Art. 2948KU
10 x 15

Art. 7055KU
13 x 18



Art. 7058KP
h. 18 x 19 P/87VE

(sezione ☺)



Art. 7059K
h. 23 x 14 F/02

(sezione ☺)



Art. 27E1KRU
h. 20 x 12 R/81K

Art. 27E3KRU
h. 20 x 12 R/81K



Art. 27E2KU
h. 20 x 9,5 F/02

Art. 27E4KU
h. 20 x 9,5 F/02



Art. 7069KP
h. 22 x 12 P/73-AK

Art. 7071KP
h. 22 x 11 P/73-AK

Art. 7198KP
h. 27 x 14 P/59-BK



Art. 7070K
h. 20 x 10 F/02

Art. 7072K
h. 20 x 10 F/02

Serie Libre



Art. 7306KPU new
h. 20 x 11 P/83

Art. 7306KRU
h. 20 x 11 R/93

Art. 7311KPU new
h. 20 x 11 P/83

Art. 7311KRU
h. 20 x 11 R/93



Art. 7307KU
h. 20 x 9,5 F/12

Art. 7312KU
h. 20 x 9,5 F/12

◆ Serie Lumina



Art. 101105K
h. 25 x 15 x 15
M/84-L M/84-P



Art. 101101K
h. 25 x 15 x 15
M/81-L M/81-P

Art. 101104K
h. 21 x 14 x 14
M/82-L M/82-P

Ossario



Cornice
Art. 2078K
7 x 9

Art. 7178KP
h. 14 x 30 P/50 F/01

Incisione gratuita

Tipo "CD" - *Abodef* Tipo "BM" ABCDEFG Tipo "BL" ABCDEF Tipo "BS" ABCDEFGH

Per un maggior mantenimento nel tempo delle nostre lampade a cera consigliamo l'utilizzo dei nostri ceri a batteria Aethernum (vedi pag. 458).



Art. 2115KRU
h. 28 x Ø 16 R/68K



Art. 2744KU
h. 28 x 17 M/54-8



Art. 1537KU
h. 22 x Ø 16 F/03



Art. 2106KU
h. 31 x 23 F/04



Art. 2105KRU
h. 54 x 30 R/08K



Art. 2103KRU
h. 18 x 30 R/66



Art. 2000KRU
h. 13 x Ø 22 R/A1



Art. 1897KPU
h. 7 x Ø 16 P/59-AK
Foro d'incasso Ø 10

Art. 2000KPU
h. 13 x Ø 22 P/A1

griglia G/10P



Art. 2107KU
h. 100 x 35 F/04



Art. 7382K
h. 85 x 22,5 x 8,5
preferibilmente per
lampade F/03

Esempio con
lampada serie
Onda 7323K



Art. 1582K
h. 13 x Ø 14
Copricentro



Art. 1682U
h. 265 x 35 mm



Art. 7565K
h. 20,5 x 14 x 10 BG/3



Art. 2744K
h. 28 x 17 M/54-8



Art. 1537K
h. 22 x Ø 16 F/03



Art. 1897KP
h. 7 x Ø 16 P/59-AK
Foro d'incasso Ø 10



Art. 1542KP
h. 4 x Ø 16 P/59-AK
Foro d'incasso Ø 10



Art. 2642K
h. 29 x 12

Art. 2630K
h. 42 x 17



Art. 2412K
h. 15 x 9

Art. 1907K
h. 25 x 17



Art. 2735K
h. 10

Art. 2736K
h. 20

Art. 2743K
h. 14



Art. 2231K
h. 24



Art. 1838K
h. 17



Art. 2830K
h. 15,5



Art. 1881K
h. 22



Art. 2354K
h. 12,8



Art. 1401K
h. 11,5



Art. 2942K
h. 24 x 14



Art. 1614K
h. 16 x 8

Art. 1647K
h. 24 x 12



Art. 716K
h. 25 x 12,5

Art. 2222K
h. 40 x 16

Art. 2216K
h. 30 x 13



Art. 1760K
h. 10 x 5
5 x 10 mm

Art. 1763K
h. 20 x 9
6 x 14 mm

Art. 1761K
h. 12 x 7
5,5 x 12 mm

Art. 1764K
h. 25 x 9
6 x 14 mm

Art. 1762K
h. 15 x 7
5,5 x 12 mm

(sezione ■)

BIONDAN
0123456789

Art. 764015L - h. 1,5
Art. 764020L - h. 2
Art. 764025L - h. 2,5
Art. 764030L - h. 3
Art. 764040L - h. 4

Art. 764050L - h. 5
Art. 764060L - h. 6
Art. 764080L - h. 8
Art. 764099L - h. 10
Art. 764000L - segni

◆ Focus traforato

Biondan
0123456789

Art. 762015L - h. 1,5
Art. 762020L - h. 2
Art. 762025L - h. 2,5
Art. 762030L - h. 3
Art. 762040L - h. 4

Art. 762050L - h. 5
Art. 762060L - h. 6
Art. 762080L - h. 8
Art. 762099L - h. 10
Art. 762000L - segni

◆ Modus traforato

Nelle ordinazioni indicare sempre l'altezza della vocale minuscola. Il prezzo verrà calcolato in base all'altezza della vocale minuscola.

A richiesta si forniscono numeri sciolti: uguale prezzo. Spessore mm 3. Per spessore superiore a mm 3 chiedere preventivo.

The height of the small letters must always be mentioned on the order. The price will be calculated on this basis.

Loose numbers (not on a bar) are available upon request at same price. Thickness 3 mm. For extra thickness please ask for a quote.

Biondan
0123456789

Art. 763015L - h. 1,5

Art. 763020L - h. 2

Art. 763025L - h. 2,5

Art. 763030L - h. 3

Art. 763040L - h. 4

Art. 763050L - h. 5

Art. 763060L - h. 6

Art. 763080L - h. 8

Art. 763099L - h. 10

Art. 763000L - segni

BIONDAN
0123456789

Art. 761015L - h. 1,5

Art. 761020L - h. 2

Art. 761025L - h. 2,5

Art. 761030L - h. 3

Art. 761040L - h. 4

Art. 761050L - h. 5

Art. 761060L - h. 6

Art. 761080L - h. 8

Art. 761099L - h. 10

Art. 761000L - segni

Nelle ordinazioni indicare sempre l'altezza della vocale minuscola. Il prezzo verrà calcolato in base all'altezza della vocale minuscola.

A richiesta si forniscono numeri sciolti: uguale prezzo. Spessore mm 3. Per spessore superiore a mm 3 chiedere preventivo.

The height of the small letters must always be mentioned on the order. The price will be calculated on this basis.

Loose numbers (not on a bar) are available upon request at same price. Thickness 3 mm. For extra thickness please ask for a quote.



Sistema di montaggio

Aa Bb Cc Dd Ee Ff Gg

Hh Ii Jj Kk Ll Mm Nn

Oo Pp Qq Rr Ss Tt Uu Vv

Ww Xx Yy Zz Ll

72

abcdefghijklmnopqrstuvwxyz

qrstuvwxyzæı

72

0123456789 n m A Ω * * †

66 33 68 70 67

Iniziale minuscola



77



77 60 61 76 64 63 62

1234567890

n m A Ω * * †

66 33 68 70 67



- Art. 7421L cm. 10 - max 4 alloggi
- Art. 7422L cm. 17 - max 6 alloggi
- Art. 7423L cm. 27 - max 10 alloggi
- Art. 7424L cm. 29,5 - max 11 alloggi
- Art. 7425L cm. 32 - max 12 alloggi

Per esempi di composizione delle barrette e misure d'ingombro vedi pag. 2-3 (bronzo).

Per quantità inferiori alla confezione e forniture di dicitura, aumento del 20%.
20% surcharge for any order less than the minimum requirement and for specific words.

Biondan

2008

◆ Art. 7626L - h. 6 - 2,7

◆ Art. 7826L - h. 8 - 4



Art. 7366L - h. 6 - 2,7

Art. 7477L - h. 8 - 4

A B C D E F G

H I J K L M N

O P Q R S T U

V W X Y Z E

72

1 2 3 4 5 6 7 8 9 0

*
70†
67v
62v
63—
64•
61v
76v
74v
75

Art. 7588 - h. 1,5

●**ÆÐŁŒ

Art. 7463 - h. 2,5

●**ÆÐŁŒ

Art. 7464 - h. 3

●**ÆÐŁŒ

Art. 7465 - h. 4

●ÆÐŁŒ

Art. 7466 - h. 5

●ÆÐŁŒ

Art. 7467 - segni

Per quantità inferiori alla confezione e forniture di diciture, aumento del 20% .

Legenda simboli: ● Lettere / * Numeri / ✱ Stelle - Croci - Æ (65) - Ð (59) - Ð (71) - Ł (72) - Œ (73)

20% surcharge for any order less than the minimum requirement and for specific words.

Symbols: ● Letters / * Figures / ✱ Stars - Crosses - Æ (65) - Ð (59) - Ð (71) - Ł (72) - Œ (73)

N O P Q R S T

U V W X Y Z

Art. 7313L - h. 1,5

Art. 7316L - h. 3

Art. 7319L - h. 6

Art. 7314L - h. 2

Art. 7317L - h. 4

Art. 7320L - h. 8

Art. 7315L - h. 2,5

Art. 7318L - h. 5

Art. 7321L - h. 10

Art. 7325L - segni

Nelle ordinazioni indicare sempre l'altezza della vocale minuscola. Il prezzo verrà calcolato in base all'altezza della vocale minuscola.

A richiesta si forniscono numeri sciolti: uguale prezzo. Spessore mm 3. Per spessore superiore a mm 3 chiedere preventivo.

The height of the small letters must always be mentioned on the order. The price will be calculated on this basis.

Loose numbers (not on a bar) are available upon request at same price. Thickness 3 mm. For extra thickness please ask for a quote.

N O P Q R S T
n o p q r s t u v w x z
? _ . v /

Art. 7290L - h. 1,5

Art. 7293L - h. 3

Art. 7296L - h. 6

Art. 7291L - h. 2

Art. 7294L - h. 4

Art. 7297L - h. 8

Art. 7292L - h. 2,5

Art. 7295L - h. 5

Art. 7298L - h. 10

Art. 7299L - segni

Nelle ordinazioni indicare sempre l'altezza della vocale minuscola. Il prezzo verrà calcolato in base all'altezza della vocale minuscola.

A richiesta si forniscono numeri sciolti: uguale prezzo. Spessore mm 3. Per spessore superiore a mm 3 chiedere preventivo.

The height of the small letters must always be mentioned on the order. The price will be calculated on this basis

Loose numbers (not on a bar) are available upon request at same price. Thickness 3 mm. For extra thickness please ask for a quote.

Art. 2724L - h. 5 - 2,5

Art. 2455L - h. 8 - 4

Art. 2723L - h. 2,5
numeri M N *+
vocali sciolte

Art. 2877L - h. 4
numeri M N *+
vocali sciolte

Art. 2057L - h. 2,5
segni

Art. 2888L - h. 4
segni

Kranderighi

Barbara

1 2 3 4 5 6 7 8 9 0

i n m u o a e

★ † - v . , ; ?

70 67 64 76 61 62 63

12 17 3 1997

CARATTERI DISPONIBILI PER INCISIONE

TIPO	
"CD"	<i>Abcdef</i>
"BM"	ABCDEFGFG
"BL"	ABCDEF
"BS"	ABCDEFGH



Esempio

Art. 2520

Prezzo a forfait per cognome, nome e date.

Standard dicitura colore oro. A richiesta disponibili versioni: nero, rosso, marrone.

CHIAVARDE PORTANTI per spessore marmo da mm 18 a mm 22 - con perno 8 MA inox V/91F **incluso nel prezzo**



Art. 2911L
mm. 44



Art. 2910L
mm. 60

Art. 2908L
mm. 80



Art. 2915L
mm. 44



Art. 2914L
mm. 60



Art. 1159L
h. 2,5

Art. 1148L
h. 4

Art. 1146L
h. 3

***Art. 1149L**
h. 5



***Art. 1239L**
Ø 4

Le borchie vengono fornite con perno V/01 da mm. 50 passo 5 MA, salvo diversa descrizione. In caso di sostituzione del perno, quello in dotazione verrà valutato al prezzo di listino.

* A richiesta possono essere fornite con perno fino a 10 MA.



Art. 1520L
h. 10 x 15

Art. 1523L
h. 11 x 20

Art. 2905L
h. 5,5 x 12

Art. 1519L
h. 7 x 10

Art. 1524L
h. 14 x 23

Art. 1528L
h. 16 x 27



Art. 2976L
h. 13 x 23
cornice massima applicabile 7 x 9

Art. 2978L
h. 18 x 29
cornice massima applicabile 9 x 12



Art. 2693L
h. 16 x 24



Art. 2977L
h. 13 x 23
cornice massima applicabile 7 x 9

Art. 2979L
h. 18 x 29
cornice massima applicabile 9 x 12



Art. 2909L
h. 17 x 25
base 12 x 8



Art. 1492L
h. 28 x 36,5
cornice massima applicabile 11 x 15

Art. 7051L
h. 25,5 x 36 x 24
cornice massima applicabile 11 x 15

Standard dicitura colore oro. A richiesta disponibili versioni: nero, rosso, marrone.

Tipo "CD" *Abode* Tipo "BM" ABCDEFG Tipo "BL" ABCDEF Tipo "BS" ABCDEFGH

Incisione gratuita
Free engraving

PREZZO ESCLUSO CORNICE
PRICE DOES NOT INCLUDE FRAME

Serie Orum



Art. 7111L
8 x 10

Art. 7112L
9 x 12

Art. 7113L
11 x 15



Art. 7115L
9 x 12

Art. 7116L
10 x 15

Art. 7098L
11 x 15

Serie Universale



Art. 1449L
7 x 9

Art. 1450L
8 x 10

Art. 1451L
9 x 12

Art. 1452L
11 x 15



Art. 297407L
7 x 9

Art. 2974L
8 x 10

Art. 2980L
9 x 12

Art. 2981L
10 x 15



Art. 7033L
9 x 12

Art. 7034L
11 x 15



Art. 7024L
9 x 12

Art. 7025L
10 x 15



Art. 7062L
9 x 12

Art. 7063L
11 x 15



Art. 7016L
9 x 12

Art. 7017L
10 x 15



Art. 2945LU
9 x 12

Art. 2946LU
11 x 15

Art. 2992LU
13 x 18



Art. 2949LU
9 x 12

Art. 2948LU
10 x 15

Art. 7055LU
13 x 18



Art. 2955LU
9 x 12

Art. 2956LU
11 x 15

Art. 7080LU
13 x 18



Art. 2959LU
9 x 12

Art. 2960LU
10 x 15

Art. 7081LU
13 x 18



Art. 2078L
7 x 9

Art. 2075L
8 x 10

Art. 2076L
9 x 12

Art. 2077L
11 x 15

Art. 2094L
13 x 18

Art. 2095L
18 x 24



Art. 138107L
7 x 9

Art. 1381L
9 x 12

Art. 1382L
10 x 15

Art. 1378L
11 x 15

Art. 1377L
13 x 18



Art. 2955L
9 x 12

Art. 2956L
11 x 15

Art. 7080L
13 x 18

Art. 7180L
18 x 24



Art. 2959L
9 x 12

Art. 2960L
10 x 15

Art. 7081L
13 x 18



■ **Art. 7410LP**
h. 20,5 x 13 x 14
P/72-CZ

■ **Art. 7543LP**
h. 20,5 x 13
P/72-CZ

■ **Art. 7409LP**
h. 30,5 x 18
P/29**Z



■ **Art. 7417L**
h. 20,5 x 9,5 x 10
F/12

■ **Art. 7488L**
h. 20,5 x 9,5 x 10
F/12



■ **Art. 7408LP**
h. 19 x 20 x 15
P/A14**Z

■ **Art. 7483LP**
h. 19 x 20
P/A14**Z



■ **Art. 733713LP (ossario)**
h. 13,5 x 7 x 7,5 P/50AV

■ **Art. 7337LP**
h. 20 x 11 x 11,5 P/83AV

■ **Art. 734413LP (ossario)**
h. 13,5 x 7 P/50AV

■ **Art. 7344LP**
h. 20 x 11 P/83AV

■ **Art. 734430LP**
h. 30 x 16 P/2901



■ **Art. 733914L (ossario)**
h. 14 x 8 x 8,5 F/01

■ **Art. 7339L**
h. 19 x 10 x 10,5 F/12

■ **Art. 734514L (ossario)**
h. 14 x 8 F/01

■ **Art. 7345L**
h. 19 x 10 F/12

■ **Art. 734523L**
h. 23 x 10,5 F/03



■ **Art. 7336LP**
h. 18,5 x 16 x 16,5
P/A10

■ **Art. 7348LP**
h. 18,5 x 16 P/A10



Art. 7259LP new
h. 19,5 x 19 x 12,5 P/A3Z

Art. 7259LR
h. 19,5 x 19 x 12,5 R/A3Z

Art. 7260LP new
h. 19,5 x 19 x 12,5 P/A3Z

Art. 7260LR
h. 19,5 x 19 x 12,5 R/A3Z



Art. 7181LR
h. 10 x 10 x 9 R/01

Art. 7182LR
h. 10 x 10 x 9 R/01

Art. 7183LR
h. 13 x 11 x 11 R/B4



Art. 7261L
h. 22 x 14 x 13 M/41-8

Art. 7262L
h. 22 x 14 x 12 M/41-8



Art. 1439L
Ø 6 F/01

Art. 1441L
Ø 8 F/03

Art. 1440L
Ø 7 F/02

Art. 1442L
Ø 11 F/04



Art. 7256L
h. 21 x 10 x 9 F/12

Art. 7257L
h. 21 x 10 x 9 F/12

Art. 7258L
h. 25 x 11 x 11 F/03



Art. 7253LP new
h. 20 x 13 x 12 P/83AV

Art. 7254LR
h. 20 x 13 x 11 R/93-AZ

Art. 7253LR
h. 20 x 13 x 12 R/93-AZ

Art. 7255LP new
h. 31 x 17,5 x 16 P/29**Z

Art. 7254LP new
h. 20 x 13 x 11 P/83AV

Art. 7255LR
h. 31 x 17,5 x 16 R/B3Z



Art. 101101L
h. 25 x 15 x 15
M/81-L M/81-P

Art. 101104L
h. 21 x 14 x 14
M/82-L M/82-P



Art. 101105L
h. 25 x 15 x 15
M/84-L M/84-P



Art. 7302LP new
h. 20,5 x 12 P/83AV

Art. 7302LR
h. 20,5 x 12 R/93-AZ

Art. 7308LP new
h. 20,5 x 12 P/83AV

Art. 7308LR
h. 20,5 x 12 R/93-AZ

Art. 7303LP new
h. 29 x 15,5 P/68

Art. 7303LR
h. 29 x 15,5 R/88-DZ



Art. 7304L
h. 20 x 10 F/12

Art. 7309L
h. 20 x 10 F/12

Art. 7323L
h. 25 x 11 F/03



Art. 7305LP new
h. 19 x 16 x 11 P/A3Z

Art. 7305LR
h. 19 x 16 x 11 R/77**Z

Art. 7310LP new
h. 19 x 16 x 11 P/A3Z

Art. 7310LR
h. 19 x 16 x 11 R/77**Z



Art. 7431LP (ossario)
h. 12 x 6 x 6,5 P/43**Z

Art. 7432LP (ossario)
h. 12 x 6 P/43**Z



Art. 7119LP new
h. 18 x 18 x 13 P/A3Z



Art. 7117L
h. 23 x 14 M/41-8

Art. 7106LR
h. 20 x 12 R/97Z

Art. 7107LR
h. 20 x 12 R/97Z

Art. 7119LR
h. 18 x 18 x 13 R/A3Z

Art. 7118L
h. 23 x 14 M/41-8

Art. 7106LP
h. 20 x 12 P/92-AZ

Art. 7107LP
h. 20 x 12 P/92-AZ

Art. 7120LP new
h. 18 x 18 x 13 P/A3Z

Art. 7108LR
h. 30 x 18 R/B3Z

Art. 7120LR
h. 18 x 18 x 13 R/A3Z

Art. 7108LP
h. 30 x 18 P/29**Z



Art. 7433L (ossario)
h. 14 x 6 x 7 F/01

Art. 7109L
h. 20 x 10 F/12

Art. 7434L (ossario)
h. 14 x 6 F/01



Art. 7111L
8 x 10

Art. 7112L
9 x 12

Art. 7113L
11 x 15



Art. 7115L
9 x 12

Art. 7116L
10 x 15

Art. 7098L
11 x 15

Art. 7110L
h. 20 x 10 F/12



Art. 7327LP new
h. 20,5 x 12 x 12,5
P/83AV

Art. 7327LR
h. 20,5 x 12 x 12,5
R/93-AZ



Art. 7330LP new
h. 20,5 x 12
P/83AV

Art. 7330LR
h. 20,5 x 12
R/93-AZ



Art. 7326LP new
h. 19 x 16 x 11,5
P/A3Z

Art. 7326LR
h. 19 x 16 x 11,5
R/77**Z

Art. 7329LP new
h. 19 x 16 x 11
P/A3Z

Art. 7329LR
h. 19 x 16 x 11
R/77**Z



Art. 7324LP
h. 17 x 27 x 11
P/A74Z

(sezione ☺)



Art. 7391LP
h. 12,6 x 4,3
P/A13

(sezione ☺)

Serie Decò

Serie Alliance



Art. 7087LP (ossario)
h. 14 x 9 x 9 P/50AV

Art. 2982LP new
h. 21 x 13 x 11 P/72

Art. 2982LR
h. 21 x 13 x 11 R/93

Art. 7089LP (ossario)
h. 14 x 9 P/50AV

Art. 2969LP new
h. 21 x 13 P/72

Art. 2969LR
h. 21 x 13 R/93

Art. 2996LP new
h. 29 x 17 P/59-DZ

Art. 2996LR
h. 29 x 17 R/88-DZ



Art. 7086LP (ossario)
h. 15 x 8 x 8 F/01

Art. 2983L
h. 20 x 10 x 11 F/02

Art. 7088L (ossario)
h. 15 x 8 F/01

Art. 2970L
h. 20 x 10 F/02

Art. 2997L
h. 25 x 12 F/03



Art. 2984L
h. 23 x 14 x 14 M/41-8

Art. 2971L
h. 23 x 14 M/41-8

Art. 29Y9L
h. 26 x 17 M/57



Art. 2985LP new
h. 18 x 20 x 15 P/70**Z

Art. 2985LR
h. 18 x 20 x 15 R/77**Z

Art. 2958LP new
h. 18 x 20 P/70**Z

Art. 2958LR
h. 18 x 20 R/77**Z



Art. 2982LPU new
h. 21 x 13 x 11 P/72

Art. 2969LRU
h. 21 x 13 R/93



Art. 2984LU
h. 23 x 14 x 14 M/41-8

Art. 2971LU
h. 23 x 14 M/41-8



Art. 2983LU
h. 20 x 10 x 11 F/02

Art. 2970LU
h. 20 x 10 F/02

Art. 2969LPU new
h. 21 x 13 P/72

Art. 2996LRU
h. 29 x 17 R/88-DZ

Art. 29Y9LU
h. 26 x 17 M/57

Art. 2997LU
h. 25 x 12 F/03



Art. 2985LPU new
h. 18 x 20 x 15 P/70**Z

Art. 2958LPU new
h. 18 x 20 P/70**Z

Art. 2985LRU
h. 18 x 20 x 15 R/77**Z

Art. 2958LRU
h. 18 x 20 R/77**Z

Serie Alliance Palladio



Art. 2982LPH new
h. 21 x 13 x 11 P/72

Art. 2982LRH
h. 21 x 13 x 11 R/93



Art. 2983LH
h. 20 x 10 x 11 F/02



Cornice
Art. 2078L
7 x 9

Art. 7178LP
h. 14 x 30 P/50AV F/01

Standard dicitura colore oro.
A richiesta disponibili versioni:
nero, rosso, marrone.



- Art. 7306LPU new h. 20 x 11 P/83AV
- Art. 7311LPU new h. 20 x 11 P/83AV
- Art. 7307LU h. 20 x 9,5 F/12
- Art. 7306LRU h. 20 x 11 R/93
- Art. 7311LRU h. 20 x 11 R/93
- Art. 7312LU h. 20 x 9,5 F/12



- Art. 7306LPH new h. 20 x 11 P/83AV
- Art. 7307LH h. 20 x 9,5 F/12
- Art. 7306LRH h. 20 x 11 R/93



Serie Delphi

- Art. 7058LP h. 18 x 19 P/87AV
- (sezione ▼)
- Art. 7059L h. 23 x 14 F/02
- (sezione ▼)



- Art. 7069LP h. 22 x 12 P/73-AZ
- Art. 7070L h. 20 x 10 F/02
- Art. 7071LP h. 22 x 11 P/73-AZ
- Art. 7072L h. 20 x 10 F/02
- Art. 7198LP h. 27 x 14 P/59-BZ



Serie Rio

- Art. 27E1LRU h. 20 x 12 R/81Z
- Art. 27E2LU h. 20 x 9,5 F/02
- Art. 27E3LRU h. 20 x 12 R/81Z
- Art. 27E4LU h. 20 x 9,5 F/02



- Art. 27E1LRH h. 20 x 12 R/81Z
- Art. 27E2LH h. 20 x 9,5 F/02



Art. 2115LRU
h. 28 x Ø 16 R/68Z



Art. 2744LU
h. 28 x 17 M/54-8



Art. 1537LU
h. 22 x Ø 16 F/03



Art. 2106LU
h. 31 x 23 F/04



Art. 2105LRU
h. 54 x 30 R/08Z



Art. 2103LRU
h. 18 x 30 R/66



Art. 2000LRU
h. 13 x Ø 22 R/A1



Art. 1897LPU
h. 7 x Ø 16 P/59-AZ
Foro d'incasso Ø 10

Art. 2000LPU
h. 13 x Ø 22 P/A1
griglia G/10P



Art. 2107LU
h. 100 x 35 F/04



Art. 7382L
h. 85 x 22,5 x 8,5

Preferibilmente per
lampade F/03



Esempio con
lampada 7323L



Art. 1582L
h. 13 x Ø 14
Copricentro



Art. 1682U
h. 265 x 35 mm



Art. 7565L
h. 20,5 x 14 x 10 BG/3



Art. 2744L
h. 28 x 17 M/54-8



Art. 1537L
h. 22 x Ø 16 F/03



Art. 1897LP
h. 7 x Ø 16 P/59-AZ
Foro d'incasso Ø 10



Art. 1542LP
h. 4 x Ø 16 P/59-AZ
Foro d'incasso Ø 10



Art. 2642L **Art. 2630L**
h. 29 x 12 h. 42 x 17



Art. 2412L **Art. 1907L**
h. 15 x 9 h. 25 x 17



Art. 2735L **Art. 2736L**
h. 10 h. 20
Art. 2743L
h. 14



Art. 2231L
h. 24



Art. 1838L
h. 17



Art. 2830L
h. 15,5



Art. 1881L
h. 22



Art. 2354L
h. 12,8



Art. 1401L
h. 11,5



Art. 2942L
h. 24 x 14



Art. 1614L
h. 16 x 8

Art. 1647L
h. 24 x 12



Art. 7161L
h. 25 x 12,5

Art. 2222L
h. 40 x 16

Art. 2216L
h. 30 x 13



Art. 1760L
h. 10 x 5
5 x 10 mm

Art. 1763L
h. 20 x 9
6 x 14 mm

Art. 1761L
h. 12 x 7
5,5 x 12 mm

Art. 1764L
h. 25 x 9
6 x 14 mm

Art. 1762L
h. 15 x 7
5,5 x 12 mm

(sezione ■)

BIONDAN
0123456789

Art. 764015J - h. 1,5

Art. 764020J - h. 2

Art. 764025J - h. 2,5

Art. 764030J - h. 3

Art. 764040J - h. 4

Art. 764050J - h. 5

Art. 764060J - h. 6

Art. 764080J - h. 8

Art. 764099J - h. 10

Art. 764000J - segni

Biondan
0123456789

Art. 762015J - h. 1,5

Art. 762020J - h. 2

Art. 762025J - h. 2,5

Art. 762030J - h. 3

Art. 762040J - h. 4

Art. 762050J - h. 5

Art. 762060J - h. 6

Art. 762080J - h. 8

Art. 762099J - h. 10

Art. 762000J - segni

Biondan
0123456789

Art. 763015J - h. 1,5

Art. 763020J - h. 2

Art. 763025J - h. 2,5

Art. 763030J - h. 3

Art. 763040J - h. 4

Art. 763050J - h. 5

Art. 763060J - h. 6

Art. 763080J - h. 8

Art. 763099J - h. 10

Art. 763000J - segni

BIONDAN
0123456789

Art. 761015J - h. 1,5

Art. 761020J - h. 2

Art. 761025J - h. 2,5

Art. 761030J - h. 3

Art. 761040J - h. 4

Art. 761050J - h. 5

Art. 761060J - h. 6

Art. 761080J - h. 8

Art. 761099J - h. 10

Art. 761000J - segni



Sistema di montaggio

Aa Bb Cc Dd Ee Ff Gg

Hh Ii Jj Kk Ll Mm Nn

Oo Pp Qq Rr Ss Tt Uu Vv

Ww Xx Yy Zz Ll

72

a b c d e f g h i j k l m n o p

q r s t u v w x y z l

72

Art. 7457 h. 6
maiuscole

Art. 7458 h. 2,7
minuscole

Art. 7459 h. 2,7
lettere terminali

Art. 7460 h. 2,7
Numeri e lettere
con perni

Art. 7462
segni

Art. 7461 - h. 2,7
Numeri e lettere
avvitabili su barretta

0 1 2 3 4 5 6 7 8 9 n m A Ω * * †

66 33 68 70 67

Iniziale minuscola



77



77 60 61 76 64 63 62

1 2 3 4 5 6 7 8 9 0

n m A Ω * * †

66 33 68 70 67



Art. 7421J

cm. 10 - max 4 alloggi

Art. 7422J

cm. 17 - max 6 alloggi

Art. 7423J

cm. 27 - max 10 alloggi

Art. 7424J

cm. 29,5 - max 11 alloggi

Art. 7425J

cm. 32 - max 12 alloggi

Per esempi di composizione delle barrette e misure d'ingombro vedi pag. 2-3 (bronzo).

Per quantità inferiori alla confezione e forniture di diciture, aumento del 20%.
20% surcharge for any order less than the minimum requirement and for specific words.

Biondan

2008

◆ Art. 7626J - h. 6 - 2,7

◆ Art. 7826J - h. 8 - 4



Art. 7366J - h. 6 - 2,7

Art. 7477J - h. 8 - 4



Art. 7426 - h. 1,5
●**ÆÞÐŁØ

Art. 7468 - h. 2,5
●**ÆÞÐŁØ

Art. 7469 - h. 3
●**ÆÞÐŁØ

Art. 7470 - h. 4
●ÆÞÐŁØ

Art. 7471 - h. 5
●ÆÞÐŁØ

Art. 7472 - segni

Per quantità inferiori alla confezione e forniture di diciture, aumento del 20%.

Legenda simboli: ● Lettere / * Numeri / ✱ Stelle - Croci - Æ (65) - Þ (59) - Ð (71) - Ł (72) - Ø (73)

20% surcharge for any order less than the minimum requirement and for specific words.

Symbols: ● Letters / * Figures / ✱ Stars - Crosses - Æ (65) - Þ (59) - Ð (71) - Ł (72) - Ø (73)



Art. 7313J - h. 1,5

Art. 7316J - h. 3

Art. 7319J - h. 6

Art. 7314J - h. 2

Art. 7317J - h. 4

Art. 7320J - h. 8

Art. 7315J - h. 2,5

Art. 7318J - h. 5

Art. 7321J - h. 10

Art. 7325J - segni

Nelle ordinazioni indicare sempre l'altezza della vocale minuscola. Il prezzo verrà calcolato in base all'altezza della vocale minuscola.

A richiesta si forniscono numeri sciolti: uguale prezzo. Spessore mm 3. Per spessore superiore a mm 3 chiedere preventivo.

The height of the small letters must always be mentioned on the order. The price will be calculated on this basis

Loose numbers (not on a bar) are available upon request at same price. Thickness 3 mm. For extra thickness please ask for a quote.

U V W X Y Z

n. m. 1 2 3 4 5 6 7 8 9 0

Art. 7290J - h. 1,5

Art. 7293J - h. 3

Art. 7296J - h. 6

Art. 7291J - h. 2

Art. 7294J - h. 4

Art. 7297J - h. 8

Art. 7292J - h. 2,5

Art. 7295J - h. 5

Art. 7298J - h. 10

Art. 7299J - segni

Nelle ordinazioni indicare sempre l'altezza della vocale minuscola. Il prezzo verrà calcolato in base all'altezza della vocale minuscola.

A richiesta si forniscono numeri sciolti: uguale prezzo. Spessore mm 3. Per spessore superiore a mm 3 chiedere preventivo.

The height of the small letters must always be mentioned on the order. The price will be calculated on this basis

Loose numbers (not on a bar) are available upon request at same price. Thickness 3 mm. For extra thickness please ask for a quote.

Art. 2724J - h. 5 - 2,5

Art. 2455J - h. 8 - 4

Art. 2723J - h. 2,5
numeri M N *+
vocali sciolte

Art. 2877J - h. 4
numeri M N *+
vocali sciolte

Art. 2057J - h. 2,5
segni

Art. 2888J - h. 4
segni

Mayer

Alex

1 2 3 4 5 6 7 8 9 0

m i n u o e a

★ † , , - v .

70 67 62 63 64 76 61

m 17 3 1997

CARATTERI DISPONIBILI PER INCISIONE

TIPO	
"CD"	<i>Abcdef</i>
"BM"	ABCDEFGFG
"BL"	ABCDEF
"BS"	ABCDEFGH



Esempio

Art. 2520

Prezzo a forfait per cognome, nome e date

Standard dicitura colore oro. A richiesta disponibili versioni: nero, rosso, marrone.

CHIAVARDE PORTANTI per spessore marmo da mm 18 a mm 22 - con perno 8 MA inox V/91F **incluso nel prezzo**

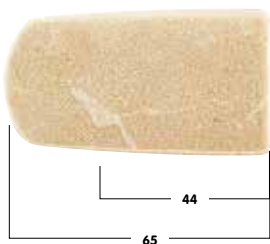

Art. 2911J
mm. 44



Art. 2910J
mm. 60

Art. 2908J
mm. 80

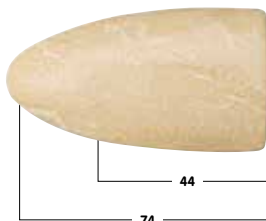

Art. 2915J
mm. 44



Art. 2914J
mm. 60



Art. 1159J
h. 2,5

Art. 1148J
h. 4

Art. 1146J
h. 3

***Art. 1149J**
h. 5



***Art. 1239J**
Ø 4

Le borchie vengono fornite con perno V/01 da mm. 50 passo 5 MA, salvo diversa descrizione. In caso di sostituzione del perno, quello in dotazione verrà valutato al prezzo di listino.

* A richiesta possono essere fornite con perno fino a 10 MA.

Incisioni
new botticino
Borchie e Chivarde



Art. 1520J
h. 10 x 15

Art. 1523J
h. 11 x 20

Art. 2905J
h. 5,5 x 12

Art. 1519J
h. 7 x 10

Art. 1524J
h. 14 x 23

Art. 1528J
h. 16 x 27



Art. 2976J
h. 13 x 23
cornice massima applicabile 7 x 9

Art. 2978J
h. 18 x 29
cornice massima applicabile 9 x 12



Art. 2693J
h. 16 x 24

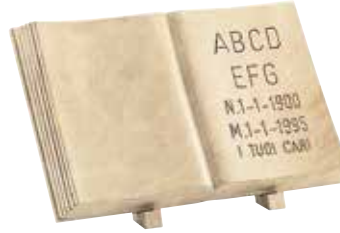

Art. 2977J
h. 13 x 23
cornice massima applicabile 7 x 9

Art. 2979J
h. 18 x 29
cornice massima applicabile 9 x 12



Art. 2909J
h. 17 x 25
base 12 x 8



Art. 1492J
h. 28 x 36,5
cornice massima applicabile 11 x 15

Art. 7051J
h. 25,5 x 36 x 24
cornice massima applicabile 11 x 15

Standard dicitura colore oro. A richiesta disponibili versioni: nero, rosso, marrone.

Tipo "CD" *Abcdef* Tipo "BM" ABCDEFG Tipo "BL" ABCDEF Tipo "BS" ABCDEFGH

Incisione gratuita
Free engraving

PREZZO ESCLUSO CORNICE
PRICE DOES NOT INCLUDE FRAME

Serie Orum



Art. 7111J
8 x 10

Art. 7112J
9 x 12

Art. 7113J
11 x 15



Art. 7115J
9 x 12

Art. 7116J
10 x 15

Art. 7098J
11 x 15

Serie Universale



Art. 1449J
7 x 9

Art. 1450J
8 x 10

Art. 1451J
9 x 12

Art. 1452J
11 x 15



Art. 297407J
7 x 9

Art. 2974J
8 x 10

Art. 2980J
9 x 12

Art. 2981J
10 x 15



Art. 7033J
9 x 12

Art. 7034J
11 x 15



Art. 7024J
9 x 12

Art. 7025J
10 x 15



Art. 7062J
9 x 12

Art. 7063J
11 x 15



Art. 7016J
9 x 12

Art. 7017J
10 x 15



Art. 2945JU
9 x 12

Art. 2946JU
11 x 15

Art. 2992JU
13 x 18



Art. 2949JU
9 x 12

Art. 2948JU
10 x 15

Art. 7055JU
13 x 18



Art. 2955JU
9 x 12

Art. 2956JU
11 x 15

Art. 7080JU
13 x 18



Art. 2959JU
9 x 12

Art. 2960JU
10 x 15

Art. 7081JU
13 x 18



Art. 2078J
7 x 9

Art. 2075J
8 x 10

Art. 2076J
9 x 12

Art. 2077J
11 x 15

Art. 2094J
13 x 18

Art. 2095J
18 x 24



Art. 13810J
7 x 9

Art. 1381J
9 x 12

Art. 1382J
10 x 15

Art. 1378J
11 x 15

Art. 1377J
13 x 18



Art. 2955J
9 x 12

Art. 2956J
11 x 15

Art. 7080J
13 x 18

Art. 7180J
18 x 24



Art. 2959J
9 x 12

Art. 2960J
10 x 15

Art. 7081J
13 x 18



Art. 7410JP
h. 20,5 x 13 x 14
P/72-CB

Art. 7543JP
h. 20,5 x 13
P/72-CB

Art. 7409JP
h. 30,5 x 18
P/29**B



Art. 7417J
h. 20,5 x 9,5 x 10
F/12

Art. 7488J
h. 20,5 x 9,5 x 10
F/12



Art. 7408JP
h. 19 x 20 x 15
P/A14**B

Art. 7483JP
h. 19 x 20
P/A14**B



Art. 733713JP (ossario)
h. 13,5 x 7 x 7,5 P/50AV

Art. 7337JP
h. 20 x 11 x 11,5 P/83AV

Art. 734413JP (ossario)
h. 13,5 x 7 P/50AV

Art. 7344JP
h. 20 x 11 P/83AV

Art. 734430JP
h. 30 x 16 P/2901



Art. 733914J (ossario)
h. 14 x 8 x 8,5 F/01

Art. 7339J
h. 19 x 10 x 10,5 F/12

Art. 734514J (ossario)
h. 14 x 8 F/01

Art. 7345J
h. 19 x 10 F/12

Art. 734523J
h. 23 x 10,5 F/03



Art. 7336JP
h. 18,5 x 16 x 16,5
P/A10

Art. 7348JP
h. 18,5 x 16 P/A10



Art. 7259JP new
h. 19,5 x 19 x 12,5 P/A3B

Art. 7259JR
h. 19,5 x 19 x 12,5 R/A3B

Art. 7260JP new
h. 19,5 x 19 x 12,5 P/A3B

Art. 7260JR
h. 19,5 x 19 x 12,5 R/A3B



Art. 7181JR
h. 10 x 10 x 9 R/01

Art. 7182JR
h. 10 x 10 x 9 R/01

Art. 7183JR
h. 13 x 11 x 11 R/B4



Art. 7261J
h. 22 x 14 x 13 M/41-8

Art. 7262J
h. 22 x 14 x 12 M/41-8



Art. 1439J
Ø 6 F/01

Art. 1440J
Ø 7 F/02

Art. 1441J
Ø 8 F/03

Art. 1442J
Ø 11 F/04



Art. 7256J
h. 21 x 10 x 9 F/12

Art. 7257J
h. 21 x 10 x 9 F/12

Art. 7258J
h. 25 x 11 x 11 F/03



Art. 7253JP new
h. 20 x 13 x 12 P/83AV

Art. 7253JR
h. 20 x 13 x 12 R/93-AB

Art. 7254JP new
h. 20 x 13 x 11 P/83AV

Art. 7254JR
h. 20 x 13 x 11 R/93-AB

Art. 7255JP new
h. 31 x 17,5 x 16 P/29**B

Art. 7255JR
h. 31 x 17,5 x 16 R/B3B



Art. 7033J
9 x 12



Art. 7024J
9 x 12



Art. 7062J
9 x 12



Art. 7016J
9 x 12

Art. 7034J
11 x 15

Art. 7025J
10 x 15

Art. 7063J
11 x 15

Art. 7017J
10 x 15



Art. 7302JP new
h. 20,5 x 12 P/83AV

Art. 7302JR
h. 20,5 x 12 R/93-AB

Art. 7308JP new
h. 20,5 x 12 P/83AV



Art. 7304J
h. 20 x 10 F/12

Art. 7309J
h. 20 x 10 F/12

Art. 7323J
h. 25 x 11 F/03



Art. 7305JP new
h. 19 x 16 x 11 P/A3B

Art. 7305JR
h. 19 x 16 x 11 R/77**B

Art. 7310JP new
h. 19 x 16 x 11 P/A3B

Art. 7310JR
h. 19 x 16 x 11 R/77**B



Art. 7431JP (ossario)
h. 12 x 6 x 6,5 P/43**B

Art. 7106JR
h. 20 x 12 R/97B

Art. 7106JP
h. 20 x 12 P/92-AB

Art. 7432JP (ossario)
h. 12 x 6 P/43**B

Art. 7107JR
h. 20 x 12 R/97B

Art. 7107JP
h. 20 x 12 P/92-AB

Art. 7108JR
h. 30 x 18 R/B3B

Art. 7108JP
h. 30 x 18 P/29**B



Art. 7119JP new
h. 18 x 18 x 13 P/A3B

Art. 7119JR
h. 18 x 18 x 13 R/A3B

Art. 7120JP new
h. 18 x 18 x 13 P/A3B

Art. 7120JR
h. 18 x 18 x 13 R/A3B



Art. 7117J
h. 23 x 14 M/41-8

Art. 7118J
h. 23 x 14 M/41-8



Art. 7433J (ossario)
h. 14 x 6 x 7 F/01

Art. 7109J
h. 20 x 10 F/12

Art. 7434J (ossario)
h. 14 x 6 F/01

Art. 7110J
h. 20 x 10 F/12



Art. 7111J
8 x 10

Art. 7112J
9 x 12

Art. 7113J
11 x 15



Art. 7115J
9 x 12

Art. 7116J
10 x 15

Art. 7098J
11 x 15



Art. 7327JP new
h. 20,5 x 12 x 12,5
P/83AV

Art. 7327JR
h. 20,5 x 12 x 12,5
R/93-AB



Art. 7328J
h. 20 x 10 x 10,5
F/12

Art. 7331J
h. 20 x 10
F/12



Art. 7326JP new
h. 18 x 16 x 11,5
P/A3B

Art. 7326JR
h. 19 x 16 x 11,5
R/77**B

Art. 7329JP new
h. 19 x 16 x 11
P/A3B

Art. 7329JR
h. 19 x 16 x 11
R/77**B



Art. 7324JP
h. 17 x 27 x 11
P/A74B
(sezione ☺)



Art. 7391JP
h. 12,6 x 4,3
P/A13
(sezione ☺)



Art. 7087JP (ossario)
h. 14 x 9 x 9 P/50AV

Art. 2982JP new
h. 21 x 13 x 11 P/72

Art. 2982JR
h. 21 x 13 x 11 R/93

Art. 7089JP (ossario)
h. 14 x 9 P/50AV

Art. 2969JP new
h. 21 x 13 P/72

Art. 2969JR
h. 21 x 13 R/93

Art. 2996JP new
h. 29 x 17 P/59-DB

Art. 2996JR
h. 29 x 17 R/88-DB



Art. 7086J (ossario)
h. 15 x 8 x 8 F/01

Art. 2983J
h. 20 x 10 x 11 F/02

Art. 7088J (ossario)
h. 15 x 8 F/01

Art. 2970J
h. 20 x 10 F/02

Art. 2997J
h. 25 x 12 F/03



Art. 2984J
h. 23 x 14 x 14
M/41-8

Art. 2971J
h. 23 x 14
M/41-8

Art. 29Y9J
h. 26 x 17
M/57



Art. 2985JP new
h. 18 x 20 x 15 P/70**B

Art. 2985JR
h. 18 x 20 x 15 R/77**B

Art. 2958JP new
h. 18 x 20 P/70**B

Art. 2958JR
h. 18 x 20 R/77**B



Art. 2982JPU new
h. 21 x 13 x 11 P/72

Art. 2982JRU
h. 21 x 13 x 11 R/93

Art. 2969JPU new
h. 21 x 13 P/72



Art. 2969JRU
h. 21 x 13 R/93

Art. 2996JPU new
h. 29 x 17 P/59-DB

Art. 2996JRU
h. 29 x 17 R/88-DB



Art. 2984JU
h. 23 x 14 x 14 M/41-8

Art. 2971JU
h. 23 x 14 M/41-8

Art. 29Y9JU
h. 26 x 17 M/57

Art. 2983JU
h. 20 x 10 x 11 F/02

Art. 2970JU
h. 20 x 10 F/02

Art. 2997JU
h. 25 x 12 F/03



Art. 2985JPU new
h. 18 x 20 x 15 P/70**B

Art. 2985JRU
h. 18 x 20 x 15 R/77**B



Art. 2958JPU new
h. 18 x 20 P/70**B

Art. 2958JRU
h. 18 x 20 R/77**B

Art. 2945JU
9 x 12

Art. 2946JU
11 x 15

Art. 2992JU
13 x 18



Art. 2949JU
9 x 12

Art. 2948JU
10 x 15

Art. 7055JU
13 x 18



Art. 7058JP
h. 18 x 19 P/87AV

(sezione ☺)



Art. 7059J
h. 23 x 14 F/02

(sezione ☺)



Art. 27E1JRU
h. 20 x 12 R/81B

Art. 27E3JRU
h. 20 x 12 R/81B



Art. 27E2JU
h. 20 x 9,5 F/02

Art. 27E4JU
h. 20 x 9,5 F/02



■ **Art. 7069JP**
h. 22 x 12 P/73-AB

■ **Art. 7071JP**
h. 22 x 11 P/73-AB

■ **Art. 7198JP**
h. 27 x 14 P/59-BB



■ **Art. 7070J**
h. 20 x 10 F/02

■ **Art. 7072J**
h. 20 x 10 F/02

Serie Libre



■ **Art. 7306JPU new**
h. 20 x 11 P/83AV

■ **Art. 7306JRU**
h. 20 x 11 R/93

■ **Art. 7311JPU new**
h. 20 x 11 P/83AV

■ **Art. 7311JRU**
h. 20 x 11 R/93



■ **Art. 7307JU**
h. 20 x 9,5 F/12

■ **Art. 7312JU**
h. 20 x 9,5 F/12



■ **Art. 101105J**
h. 25 x 15 x 15
M/84-L M/84-P



■ **Art. 101101J**
h. 25 x 15 x 15
M/81-L M/81-P

■ **Art. 101104J**
h. 21 x 14 x 14
M/82-L M/82-P



Cornice
■ **Art. 2078J**
7 x 9

■ **Art. 7178JP**
h. 14 x 30 P/50AV F/01

Standard dicitura colore oro.
A richiesta disponibili versioni:
nero, rosso, marrone.

Incisione gratuita - Free engraving Tipo "CD" *Abede* Tipo "BM" ABCDEFG Tipo "BL" ABCDEF Tipo "BS" ABCDEFGH

Per un maggior mantenimento nel tempo delle nostre lampade a cera consigliamo l'utilizzo dei nostri ceri a batteria Aethernum (vedi pag. 458).



Art. 2115JRU
h. 28 x Ø 16 R/68B



Art. 2744JU
h. 28 x 17 M/54-8



Art. 1537JU
h. 22 x Ø 16 F/03



Art. 2106JU
h. 31 x 23 F/04



Art. 2105JRU
h. 54 x 30 R/08B



Art. 2103JRU
h. 18 x 30 R/66



Art. 2000JRU
h. 13 x Ø 22 R/A1



Art. 1897JPU
h. 7 x Ø 16 P/59-AB
Foro d'incasso Ø 10

Art. 2000JPU
h. 13 x Ø 22 P/A1

griglia G/10P



Art. 2107JU
h. 100 x 35 F/04



Art. 7382J
h. 85 x 22,5 x 8,5

Preferibilmente per
lampade F/03



Esempio con
lampada 7323J

Art. 1582J
h. 13 x Ø 14
Copricentro

Art. 1682U
h. 265 x 35 mm



Art. 7565J
h. 20,5 x 14 x 10 BG/3



Art. 2744J
h. 28 x 17 M/54-8



Art. 1537J
h. 22 x Ø 16 F/03



Art. 1897JP
h. 7 x Ø 16 P/59-AB
Foro d'incasso Ø 10



Art. 1542JP
h. 4 x Ø 16 P/59-AB
Foro d'incasso Ø 10



Art. 2642J
h. 29 x 12

Art. 2630J
h. 42 x 17



Art. 2412J
h. 15 x 9

Art. 1907J
h. 25 x 17



Art. 2735J
h. 10

Art. 2736J
h. 20

Art. 2743J
h. 14



Art. 2231J
h. 24



Art. 1838J
h. 17



Art. 2830J
h. 15,5



Art. 1881J
h. 22



Art. 2354J
h. 12,8



Art. 1401J
h. 11,5



Art. 2942J
h. 24 x 14



Art. 1614J
h. 16 x 8

Art. 1647J
h. 24 x 12



Art. 7161J
h. 25 x 12,5

Art. 2222J
h. 40 x 16

Art. 2216J
h. 30 x 13



Art. 1760J
h. 10 x 5
5 x 10 mm

Art. 1763J
h. 20 x 9
6 x 14 mm

Art. 1761J
h. 12 x 7
5,5 x 12 mm

Art. 1764J
h. 25 x 9
6 x 14 mm

Art. 1762J
h. 15 x 7
5,5 x 12 mm

(sezione ■)

CURA LA NOSTRA QUALITÀ CARE OF OUR QUALITY

ARTICOLI IN BRONZO - OTTONE E FINITURE CUBIC SMALTATO BIANCO - BRILLIANT BLACK - MERCURIO PALLADIO

1. Per la pulizia utilizzare solamente panni morbidi e acqua.

L'utilizzo di panni ruvidi può danneggiare la finitura del prodotto e favorirne l'ossidazione.

Si consiglia l'utilizzo del nostro Spray lucidante e conservante LUXOR a base di cera. Non utilizzare prodotti chimici generici.

2. Per il montaggio **NON UTILIZZARE SILICONE ACETICO** e maneggiare con cura.

I prodotti verniciati sono delicati. L'impatto con superfici rigide può danneggiare lo strato protettivo alterando di molto la tenuta alle ossidazioni.

3. I prodotti in bronzo ed ottone tendono ad ossidarsi naturalmente. Seguire le istruzioni sopra riportate per ritardarne l'effetto.

BRONZE - BRASS ARTICLES AND CUBIC - WHITE ENAMEL BRILLIANT BLACK - MERCURIO - PALLADIO FINISHING

1. For cleaning use soft cloths and water only.

Rough cloths might damage the product surface and enhance oxidation.

We recommend our LUXOR polishing and wax base Spray and preservative. Do not use unbranded chemical products.

2. When mounting, **DO NOT USE ACETIC SILICONE** and handle with care. Painted products are delicate.

Contact with hard surfaces might damage the protective layer and accelerate oxidation.

3. Bronze and brass articles tend to oxidate naturally. Please follow the above instructions to delay this effect.



ARTICOLI IN ACCIAIO INOSSIDABILE

1. Lavare gli articoli inox con l'utilizzo di una spugnetta o un panno morbido.

Utilizzare acqua, detersivo neutro oppure prodotti specifici per la pulizia e manutenzione dell'acciaio reperibili in commercio, facendo attenzione che tali prodotti non entrino in contatto con le superfici di marmo sulle quali normalmente sono fissati gli articoli.

Non utilizzare spugne o panni abrasivi che potrebbero rigare la superficie e favorire il deposito di pollini, smog e polvere.

STAINLESS STEEL ARTICLES

1. Wash stainless steel items with a soft cloth.

Use water, neutral detergents or specific products for steel cleaning and maintenance which are commercially available, make sure they do not touch the marble slab on which the articles are normally mounted.

Do not use abrasive cloths which might scratch the surface and enhance pollen, smog and dust deposition.



Smaltato Bianco

FINITURA BIANCO SMALTATO

- Articoli in bronzo verniciati a polvere bianca a cottura 200°.
- Alta resistenza agli agenti atmosferici.
- Ideali per le zone di mare.
- Testati in laboratorio.
- Garanzia di lunga durata.
- Abbinabili ai nostri articoli in porcellana bianca.

WHITE ENAMEL FINISH

- Bronze items finished with white powder varnish and baked at 200°.
- High resistance to weathering.
- Ideal for coastal areas.
- Laboratory tested.
- Long-term guarantee.
- Can be combined with our white porcelain articles.



Scritte personalizzate
in un unico pezzo

♦ **Art. 7626W**
h. 6 - 2,7

• • • - ▽

Art. 7366W - segni
h. 6 - 2,7



Art. 7419 - h. 1,5

● ** * Æ Þ Ð Æ Ø

Art. 7138 - h. 2,5

● ** * Æ Þ Ð Æ Ø

Art. 7209 - h. 3

● ** * Æ Þ Ð Æ Ø

Art. 7139 - h. 4

● Æ Þ Ð Æ Ø

Art. 7210 - h. 5

● Æ Þ Ð Æ Ø

• • • - ▽

Art. 7140 - segni



Legenda simboli:

● Lettere / * Numeri / * Stelle - Croci
Æ (65) - Þ (59) - Ð (71) - Æ (72) - Ø (73)

Symbols:

● Letters / * Figures / * Stars - Crosses
Æ (65) - Þ (59) - Ð (71) - Æ (72) - Ø (73)



Art. 7418 - h. 1,5

● ** * + ■ Æ Þ Ð Æ Ø

Art. 7169 - h. 2,5

● ** * Æ Þ Ð Æ Ø

Art. 7171 - h. 4

● * Æ Þ Ð Æ Ø

Art. 7170 - h. 3

● ** * Æ Þ Ð Æ Ø

Art. 7172 - h. 5

● Æ Þ Ð Æ Ø

• • • - ▽

Art. 7174 - segni



Art. 2724W
h. 5 - 2,5

Art. 2455W
h. 8 - 4

Art. 2723W - h. 2,5
numeri MN
vocali sciolte

Art. 2877W - h. 4
numeri MN
vocali sciolte

☉ ☽ ☼ ☾ ☽
Art. 2057W
segni h. 2,5

Art. 2888W
segni h. 4



Art. 7566W
fino a cm 12 x 10

Art. 756601W
fino a cm 18 x 15

Art. 756602W
fino a cm 24 x 20



Art. 7568W
fino a cm 8 x 15

Art. 756801W
fino a cm 16 x 28

Art. 756802W
fino a cm 20 x 35



Art. 7567W
fino a cm 8 x 15

Art. 756701W
fino a cm 16 x 28

Art. 756702W
fino a cm 20 x 35



Dettaglio del rilievo

Dicitura con lettere in rilievo compresa nel prezzo
Caratteri in rilievo: Vedi finitura bronzo a pag. 19
Free inscription

Caratteri in rilievo

Tipo "BM" ABCDEFG Tipo "BL" ABCDEF

Tipo "BS" ABCDEFGH Tipo "RL" ABCDEFGH



Art. 7559W
h. 8,5 x 8,5

Standard dicitura colore oro.
A richiesta disponibili versioni: nero, rosso, marrone

Incisione gratuita
Free engraving

Tipo "CD" Abcdef Tipo "BM" ABCDEFG

Tipo "BL" ABCDEF Tipo "BS" ABCDEFGH



Art. 2693W
h. 16 x 24



Art. 2909W
h. 17 x 25 - base 12 x 8



Art. 2976W
h. 13 x 23
cornice massima applicabile 7 x 9

Art. 2978W
h. 18 x 29
cornice massima applicabile 9 x 12

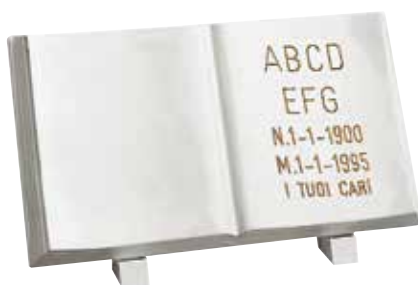

Art. 2977W
h. 13 x 23
cornice massima applicabile 7 x 9

Art. 2979W
h. 18 x 29
cornice massima applicabile 9 x 12



Art. 1492W
h. 28 x 36,5

Art. 7051W
h. 25,5 x 36 x 24
cornice massima applicabile 11 x 15 (a destra)
cornice massima applicabile 9 x 12 (a sinistra)



Art. 2905W
h. 5,5 x 12

Art. 1519W
h. 7 x 10

Art. 1520W
h. 10 x 15

Art. 1523W
h. 11 x 20

Art. 1524W
h. 14 x 23

Art. 1528W
h. 16 x 27



Art. 7033W
9 x 12
Art. 7034W
11 x 15



Art. 7024W
9 x 12
Art. 7025W
10 x 15



Art. 7062W
9 x 12
Art. 7063W
11 x 15



Art. 7016W
9 x 12
Art. 7017W
10 x 15



Art. 2945W
9 x 12
Art. 2946W
11 x 15
Art. 2992W
13 x 18



Art. 2949W
9 x 12
Art. 2948W
10 x 15
Art. 7055W
13 x 18



Art. 2955WU
9 x 12
Art. 2956WU
11 x 15
Art. 7080WU
13 x 18



Art. 2959WU
9 x 12
Art. 2960WU
10 x 15
Art. 7081WU
13 x 18



Art. 2078W
7 x 9
Art. 2075W
8 x 10
Art. 2076W
9 x 12
Art. 2077W
11 x 15
Art. 2094W
13 x 18
Art. 2095W
18 x 24



Art. 138107W
7 x 9
Art. 1381W
9 x 12
Art. 1382W
10 x 15
Art. 1378W
11 x 15
Art. 1377W
13 x 18



Art. 2955W
9 x 12
Art. 2956W
11 x 15
Art. 7080W
13 x 18
Art. 7180W
18 x 24



Art. 2959W
9 x 12
Art. 2960W
10 x 15
Art. 7081W
13 x 18



Art. 7111W

8 x 10

Art. 7112W

9 x 12

Art. 7113W

11 x 15



Art. 7115W

9 x 12

Art. 7116W

10 x 15

Art. 7098W

11 x 15

CHIAVARDE PORTANTI per spessore marmo da mm 9 a mm 22 - con perno 8 MA inox V/81 **incluso nel prezzo**



Art. 113608W

mm. 30

Art. 113508W

mm. 40



Art. 120208W

mm. 60

Art. 120108W

mm. 80

CHIAVARDE PORTANTI per spessore marmo da mm 18 a mm 22 - con perno 8 MA inox V/91F **incluso nel prezzo**

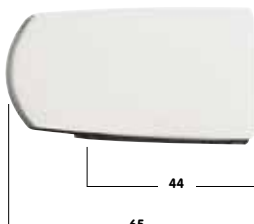

Art. 2911W

mm. 44

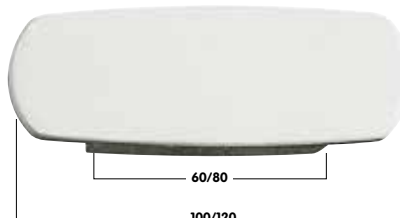

Art. 2910W

mm. 60

Art. 2908W

mm. 80

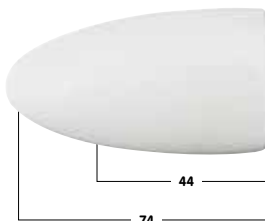

Art. 2915W

mm. 44

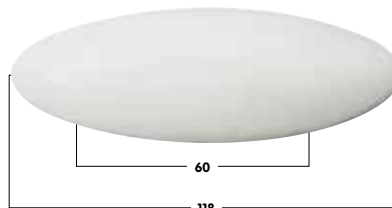

Art. 2914W

mm. 60



Art. 1159W

h. 2,5

Art. 1146W

h. 3

Art. 1148W

h. 4

***Art. 1149W**

h. 5



***Art. 1239W**

Ø 4



Art. 1683W

Ø 8

Art. 1684W

Ø 11 Portante

Le borchie vengono fornite con perno V/01 da mm. 50 passo 5 MA, salvo diversa descrizione.
In caso di sostituzione del perno, quello in dotazione verrà valutato al prezzo di listino.

* A richiesta possono essere fornite con perno fino a 10 MA.



Art. 7259WR
h. 19,5 x 19 x 12,5
R/A3Z

Art. 7259WP
h. 19,5 x 19 x 12,5
P/A3Z



Art. 7260WR
h. 19,5 x 19 x 12,5
R/A3Z

Art. 7260WP
h. 19,5 x 19 x 12,5
P/A3Z



Art. 7181WR
h. 10 x 10 x 9 R/01

Art. 7182WR
h. 10 x 10 x 9 R/01

Art. 7183WR
h. 13 x 11 x 11 R/B4

Art. 7261W
h. 22 x 14 x 13 M/41-8

Art. 7262W
h. 22 x 14 x 12 M/41-8



Art. 1439W
Ø 6 F/01

Art. 1440W
Ø 7 F/02



Art. 1441W
Ø 8 F/03

Art. 1442W
Ø 11 F/04



Art. 7256W
h. 21 x 10 x 9 F/12

Art. 7257W
h. 21 x 10 x 9 F/12

Art. 7258W
h. 25 x 11 x 11 F/03

Art. 7253WR
h. 20 x 13 x 12
R/93-AZ

Art. 7253WP
h. 20 x 13 x 12
P/83AV

Art. 7254WR
h. 20 x 13 x 11
R/93-AZ

Art. 7254WP
h. 20 x 13 x 11
P/83AV

Art. 7255WR
h. 31 x 17,5 x 16
R/B3Z

Art. 7255WP
h. 31 x 17,5 x 16
P/29**Z



Art. 7033W
9 x 12

Art. 7034W
11 x 15



Art. 7024W
9 x 12

Art. 7025W
10 x 15



Art. 7062W
9 x 12

Art. 7063W
11 x 15



Art. 7016W
9 x 12

Art. 7017W
10 x 15

Serie Solaris



Art. 755214WP
(ossario)
h. 14 x 7
P/50AV

Art. 7552WP
h. 20 x 12
P/83AV

Art. 755014WP
(ossario)
h. 14 x 6,5
P/50AV

Art. 7550WP
h. 20 x 11 P/83AV

Art. 755029WP
h. 29 P/2901



Art. 755314W
(ossario)
h. 14 x 6,5 F/01

Art. 7553W
h. 20 x 9 F/12

Art. 755114W
(ossario)
h. 14 x 5,5 F/01

Art. 7551W
h. 20 x 8 F/12

Art. 755126W
h. 27 x 11,5 F/03



Art. 7555WP
h. 17 x 12
P/A3Z

Art. 7554WP
h. 17 x 11
P/A3Z

Serie Dune



Art. 730114WP
(ossario)
h. 14 x 7 P/75Z

Art. 7301WP
h. 20 x 9,5 P/17DZ

Art. 736314WP
(ossario)
h. 14 x 7 P/75Z

Art. 7363WP
h. 20 x 9,5 P/17DZ



Art. 735114W
(ossario)
h. 14 x 6,5 F/01

Art. 7351W
h. 20 x 8 F/12

Art. 736414W
(ossario)
h. 14 x 6,5 F/01

Art. 7364W
h. 20 x 7 F/12



Art. 7401WP
h. 17,5 x 12
P/70**Z

Art. 7365WP
h. 17,5 x 11
P/70**Z

Serie Rose



Art. 7242WR
h. 20,5 x 12 x 12,5
R/93-AZ

Art. 7242WP
h. 20,5 x 12 x 12,5
P/83AV

Art. 7243WR
h. 20,5 x 12 R/93-AZ

Art. 7243WP
h. 20,5 x 12 P/83AV

Art. 7244WR
h. 29 x 15,5 R/88-DZ



Art. 7041WR
h. 10 x 10
R/87

Art. 7042WR
h. 10 x 10
R/87



Art. 7245W
h. 20 x 10 x 10,5
F/12

Art. 7246W
h. 20 x 10
F/12

Art. 7247W
h. 27 x 11,5
F/03



Art. 7248WR
h. 19 x 16 x 11,5
R/77**Z

Art. 7248WP
h. 19 x 16 x 11,5
P/70**Z

Art. 7249WR
h. 19 x 16 x 11
R/77**Z

Art. 7249WP
h. 19 x 16 x 11
P/70**Z



Art. 733713WP
(ossario)
h. 13,5 x 7 x 7,5
P/50AV



Art. 733914W
(ossario)
h. 14 x 8 x 8,5
F/01



Art. 7336WP
h. 18,5 x 16 x 12,5
P/A10

Art. 7337WP
h. 20 x 11 x 11,5
P/83AV

Art. 7344WP
h. 20 x 11 P/83AV

Art. 734514W
(ossario)
h. 14 x 8 F/01

Art. 7345W
h. 19 x 10 F/12

Art. 7348WP
h. 18,5 x 16
P/A10

Art. 734430WP
h. 30 x 16 P/2901

Art. 7339W
h. 19 x 10 x 10,5
F/12

Art. 734523W
h. 23 x 10,5
F/03



Art. 753913WP
(ossario)
h. 12 x 6,5 x 7
P/A11



Art. 754014W
(ossario)
h. 14 x 7 x 7,5
F/01



Art. 7538WP
18,5 x 16 x 12,5
P/A10

Art. 7548WP
h. 18,5 x 16
P/A10

Art. 753916WP
h. 16 x 9 P/65**Z

Art. 7544WP
h. 20 x 11 P/92-AZ

Art. 7540W
h. 19 x 9 x 9,5
F/02

Art. 7545W
h. 19 x 9
F/02

Art. 7539WP
h. 20 x 11 x 11,5
P/92-AZ

Art. 753930WP
h. 29 x 16
P/29-AZ

Art. 7541W
h. 23 x 10 F/03



Art. 7391WP
h. 12,6 x 4,3
P/A13



Art. 7097W
h. 10 x 5 P/55
(ossario)

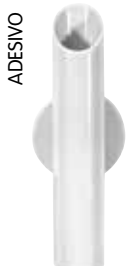

ADESIVO

Art. 7067W
h. 13 x 4,5 P/38
(ossario)



Art. 2268W
h. 10,5 x 8 x 7,5
B/11
(ossario)



Art. 2149WP
h. 9 x 8 x 7,5
P/76
(ossario)



Art. 2148W
h. 12,5 x 8
F/01
(ossario)

(sezione ▾)

Art. 709717W
h. 17 P/55
(ossario)

Art. 706717W
h. 17 P/38
(ossario)



Art. 7302WP new
h. 20,5 x 12 P/83AV

Art. 7308WR
h. 20,5 x 12 R/93-AZ



Art. 7304W
h. 20 x 10 F/12



Art. 7305WP new
h. 19 x 16 x 11 P/A3Z

Art. 7310WP new
h. 19 x 16 x 11 P/A3Z

Art. 7302WR
h. 20,5 x 12 R/93-AZ

Art. 7303WP new
h. 29 x 15,5 P/68

Art. 7309W
h. 20 x 10 F/12

Art. 7305WR
h. 19 x 16 x 11 R/77**Z

Art. 7310WR
h. 19 x 16 x 11 R/77**Z

Art. 7308WP new
h. 20,5 x 12 P/83AV

Art. 7303WR
h. 29 x 15,5 R/88-DZ

Art. 7323W
h. 25 x 11 F/03

Serie Onda



Art. 7119WR
h. 18 x 18 x 13
R/A3Z

Art. 7120WR
h. 18 x 18 x 13
R/A3Z



Art. 7117W
h. 23 x 14
M/41-8

Art. 7118W
h. 23 x 14
M/41-8



Art. 7433W (ossario)
h. 14 x 6 x 7 F/01

Art. 7109W
h. 20 x 10 F/12

Art. 7434W (ossario)
h. 14 x 6 F/01

Art. 7110W
h. 20 x 10 F/12



Art. 7431WP (ossario)
h. 12 x 6 x 6,5
P/43**Z

Art. 7106WR
h. 20 x 12
R/97Z

Art. 7106WP
h. 20 x 12
P/92-AZ

Art. 7432WP (ossario)
h. 12 x 6 P/43**Z

Art. 7107WR
h. 20 x 12 R/97Z

Art. 7107WP
h. 20 x 12 P/92-AZ

Art. 7108WR
h. 30 x 18 R/B3Z

Art. 7108WP
h. 30 x 18 P/29**Z

Serie Lotus



Art. 4603WP
h. 17 x 10
P/A2**Z



Art. 4627WP
h. 20 x 12
P/28-CZ

Art. 4626W
h. 20 x 10
F/02



Art. 7111W
8 x 10

Art. 7112W
9 x 12

Art. 7113W
11 x 15



Art. 7115W
9 x 12

Art. 7116W
10 x 15

Art. 7098W
11 x 15



Art. 7327WP new
h. 20,5 x 12 x 12,5
P/83AV

Art. 7330WP new
h. 20,5 x 12
P/83AV



Art. 7328W
h. 20 x 10 x 10,5
F/12



Art. 7326WP new
h. 19 x 16 x 11,5
P/A3Z

Art. 7329WP new
h. 19 x 16 x 11
P/A3Z

Art. 7327WR
h. 20,5 x 12 x 12,5
R/93-AZ

Art. 7330WR
h. 20,5 x 12
R/93-AZ

Art. 7331W
h. 20 x 10
F/12

Art. 7326WR
h. 19 x 16 x 11,5
R/77**Z

Art. 7329WR
h. 19 x 16 x 11
R/77**Z

Serie Decò



Art. 7102WR
h. 20 x 12
R/97Z

Art. 7105WR
h. 20 x 12
R/97Z



Art. 7100WR
h. 19 x 17 x 12
R/A3Z



Art. 7101W
h. 20 x 10 F/12

Art. 7102WP
h. 20 x 12
P/92-AZ

Art. 7105WP
h. 20 x 12
P/92-AZ

Art. 7103WR
h. 19 x 17
R/A3Z

Art. 7104W
h. 20 x 9,5 F/12

Serie Impero



Art. 2984WU
h. 23 x 14 x 14 M/41-8



Art. 27E1WRU
h. 20 x 12 R/81Z



Art. 27E2WU
h. 20 x 9,5 F/02

Art. 2971WU
h. 23 x 14 M/41-8

Art. 27E3WRU
h. 20 x 12 R/81Z

Art. 27E4WU
h. 20 x 9,5 F/02

Serie Rio





Art. 7069WP
h. 22 x 12 P/73-AZ



Art. 2744W
h. 28 x 17 M/54-8



Art. 7070W
h. 20 x 10 F/02



Art. 2984W
h. 23 x 14 x 14 M/41-8

Art. 7071WP
h. 22 x 11 P/73-AZ

Art. 7072W
h. 20 x 10 F/02

Art. 2971W
h. 23 x 14 M/41-8

Art. 7198WP
h. 27 x 14 P/59-BZ



Art. 7058WP
h. 18 x 19 P/87AV

(sezione ☺)



Art. 7059W
h. 23 x 14 F/02

(sezione ☺)



Art. 7410WP
h. 20,5 x 13 x 14
P/72-CZ



Art. 7417W
h. 20,5 x 9,5 x 10
F/12



Art. 7408WP
h. 19 x 20 x 15
P/A14**Z

Art. 7543WP
h. 20,5 x 13
P/72-CZ

Art. 7488W
h. 20,5 x 9,5 x 10
F/12

Art. 7483WP
h. 19 x 20
P/A14**Z

Art. 7409WP
h. 30,5 x 18
P/29**Z



Art. 7087WP
h. 14 x 9 x 9 P/50AV

Art. 7089WP
h. 14 x 9 P/50AV



Art. 7086W
h. 15 x 8 F/01

Art. 7088W
h. 15 x 8 F/01



Art. 2638WP
h. 11,5 x 6 x 5
P/43**Z

Art. 2697WP
h. 11,5 x Ø 6
P/43**Z



Art. 2641W
h. 13,5 x Ø 6
F/01

Art. 2698W
h. 13,5 x Ø 6
F/01



Art. 7076W

h. 20 x 10

Art. 1827W

h. 28 x 12

Art. 1833W

h. 39 x 17

Art. 2950W

h. 48 x 20



Art. 2735W

h. 10

Art. 2736W

h. 20

Art. 2743W

h. 14



Art. 7166W

h. 14,5 x 9,5

Art. 2098/SW

h. 20



Art. 4858W

h. 9 x 6

Art. 2412W

h. 15 x 9

Art. 1907W

h. 25 x 17



Art. 2675W

h. 12

Art. 2680W

h. 16

Art. 2676W

h. 20



Art. 1713W

h. 14 x 14



Art. 7167W
h. 14,5 x 9



Art. 1837W
h. 12

Art. 1838W
h. 17



Art. 2231W
h. 24



Art. 7289W
h. 13 x 11,5
Padre Pio



Art. 7300W
h. 21 x 13
Padre Pio



Art. 7186W
h. 14,5 x 14,5
Padre Pio



Art. 1881W
h. 22



Art. 2581/SW
h. 21



Art. 2581/DW
h. 21



Art. 2127W
h. 20 x 10



Art. 2128W
h. 25 x 10



Art. 1806W
h. 14 x 8



Art. 4214W
h. 8 x 5

Art. 1807W
h. 19 x 10



Art. 1614W
h. 16 x 8



(sezione ■)

Art. 1760W
h. 10 x 5 5 x 10 mm

Art. 1763W
h. 20 x 9 6 x 14 mm

Art. 1761W
h. 12 x 7 5,5 x 12 mm

Art. 1764W
h. 25 x 9 6 x 14 mm

Art. 1762W
h. 15 x 7 5,5 x 12 mm



Art. 716116W
h. 16 x 8

Art. 7161W
h. 25 x 12,5

Art. 2216W
h. 30 x 13

Art. 2222W
h. 40 x 16

Bronzo dipinto a Mano

BRONZO DIPINTO A MANO

Finitura realizzata completamente a mano con vernici ad alta protezione per mezzo di attrezzature altamente professionali. Data la particolarità della lavorazione possono essere considerati "pezzi unici".

HAND-PAINTED BRONZE

This completely handmade finish is achieved by means of high protection paint and cutting-edge technology. Due to the special manufacturing technique, the pieces can be considered "unique".





Art. 7410V3P
h. 20,5 x 13 x 14
P/83AV

Art. 7543V3P
h. 20,5 x 13 x 14
P/83AV



Art. 7417V3
h. 20,5 x 9,5 x 10
F/12

Art. 7488V3
h. 20,5 x 9,5 x 10
F/12



Art. 2076V3
9 x 12

Art. 2077V3
11 x 15



Art. 7408V3P
h. 19 x 20 x 15
P/A14**Z

Art. 7483V3P
h. 19 x 20
P/A14**Z



Art. 7410V4P
h. 20,5 x 13 x 14
P/83

Art. 7543V4P
h. 20,5 x 13 x 14
P/83



Art. 7417V4
h. 20,5 x 9,5 x 10
F/12

Art. 7488V4
h. 20,5 x 9,5 x 10
F/12



Art. 2076V4
9 x 12

Art. 2077V4
11 x 15



Art. 7408V4P
h. 19 x 20 x 15
P/A14**B

Art. 7483V4P
h. 19 x 20
P/A14**B



finitura Brilliant Black

1. Articoli in bronzo con finitura Nero Brillante realizzata con 4 mani di vernice
2. Colore brillante impregniato dalla luce solare
3. Alta resistenza agli agenti atmosferici
4. Ideale per le zone di mare
5. Testato in laboratorio
6. Garanzia di lunga durata



BIONDAN
0123456789

Art. 764015Y - h. 1,5
Art. 764020Y - h. 2
Art. 764025Y - h. 2,5
Art. 764030Y - h. 3
Art. 764040Y - h. 4
Art. 764050Y - h. 5
Art. 764060Y - h. 6
Art. 764080Y - h. 8
Art. 764099Y - h. 10
Art. 764000Y - segni

◆ Focus traforato

brilliant black

Biondan
0123456789

Art. 762015Y - h. 1,5
Art. 762020Y - h. 2
Art. 762025Y - h. 2,5
Art. 762030Y - h. 3
Art. 762040Y - h. 4
Art. 762050Y - h. 5
Art. 762060Y - h. 6
Art. 762080Y - h. 8
Art. 762099Y - h. 10
Art. 762000Y - segni

◆ Modus traforato

Biondan
0123456789

Art. 763015Y - h. 1,5
Art. 763020Y - h. 2
Art. 763025Y - h. 2,5
Art. 763030Y - h. 3
Art. 763040Y - h. 4
Art. 763050Y - h. 5
Art. 763060Y - h. 6
Art. 763080Y - h. 8
Art. 763099Y - h. 10
Art. 763000Y - segni

◆ Romano corsivo traforato

BIONDAN
0123456789

Art. 761015Y - h. 1,5
Art. 761020Y - h. 2
Art. 761025Y - h. 2,5
Art. 761030Y - h. 3
Art. 761040Y - h. 4
Art. 761050Y - h. 5
Art. 761060Y - h. 6
Art. 761080Y - h. 8
Art. 761099Y - h. 10
Art. 761000Y - segni

◆ Avant traforato

Nelle ordinazioni indicare sempre l'altezza della vocale minuscola. Il prezzo verrà calcolato in base all'altezza della vocale minuscola. A richiesta si forniscono numeri sciolti: uguale prezzo. Per spessore superiore a mm 3 chiedere preventivo.

The height of the small letters must always be mentioned on the order. The price will be calculated on this basis. Loose numbers (not on a bar) are available upon request at same price. For extra thickness please ask for a quote.

Serie Dune



Art. 735114Y
(ossario)
h. 14 x 6,5 F/01

Art. 7351Y
h. 20 x 8 F/12



Art. 736414Y
(ossario)
h. 14 x 6,5 F/01

Art. 7364Y
h. 20 x 7 F/12



Art. 730114YP
(ossario)
h. 14 x 7 P/75

Art. 7301YP
h. 20 x 9,5 P/17DY

Art. 736314YP
(ossario)
h. 14 x 7 P/75

Art. 7363YP
h. 20 x 8,5 P/17DY

Art. 7401YP
h. 17,5 x 12 P/70**Y

Art. 7365YP
h. 17,5 x 11 P/70**Y

Serie Solaris



Art. 755314Y
(ossario)
h. 14 x 6,5 F/01

Art. 7553Y
h. 20 x 9 F/12

Art. 755114Y
(ossario)
h. 14 x 5,5 F/01

Art. 7551Y
h. 20 x 8 F/12

Art. 755126Y
h. 27 x 11,5 F/03



Art. 755214YP
(ossario)
h. 14 x 7 P/50

Art. 7552YP
h. 20 x 12 P/60

Art. 755014YP
(ossario)
h. 14 x 6,5 P/50

Art. 7550YP
h. 20 x 11 P/60

Art. 755029YP
h. 29 P/29**Y



Art. 7555YP
h. 17 x 12 P/A3Y

Art. 7554YP
h. 17 x 11 P/A3Y

Serie Global



Art. 7417Y
h. 20,5 x 9,5 x 10
F/12

Art. 7488Y
h. 20,5 x 9,5 x 10
F/12



Art. 7410YP
h. 20,5 x 13 x 14
P/72-CY

Art. 7543YP
h. 20,5 x 13
P/72-CY

Art. 7409YP
h. 30,5 x 18
P/29**Y



Art. 7408YP
h. 19 x 20 x 15
P/A14**Y

Art. 7483YP
h. 19 x 20
P/A14**Y



■ **Art. 7087YP**
h. 14 x 9 x 9 P/50

■ **Art. 7089YP**
h. 14 x 9 P/50



■ **Art. 7086Y**
h. 15 x 8 x 8 F/01

■ **Art. 7088Y**
h. 15 x 8 F/01



■ **Art. 733713YP**
h. 13,5 x 7 x 7,5 P/50

■ **Art. 734413YP**
h. 13,5 x 7 P/50



■ **Art. 733914Y**
h. 14 x 8 x 8,5 F/01

■ **Art. 734514Y**
h. 14 x 8 F/01

Serie Egadi



■ **Art. 753913YP**
h. 12 x 6,5 x 7 P/A11

■ **Art. 754413YP**
h. 12 x 6,5 P/A11



■ **Art. 754014Y**
h. 14 x 7 x 7,5 F/01

■ **Art. 754514Y**
h. 14 x 7 F/01

Serie Capri



■ **Art. 7431YP**
h. 12 x 6 x 6,5 P/43**Y

■ **Art. 7432YP**
h. 12 x 6 P/43**Y



■ **Art. 7433Y**
h. 14 x 6 x 7 F/01

■ **Art. 7434Y**
h. 14 x 6 F/01

Serie Orum



■ **Art. 2638YP**
h. 11,5 x 6 x 5 P/43**Y

■ **Art. 2697YP**
h. 11,5 x 6 x 6 P/43**Y



■ **Art. 2641Y**
h. 13,5 x Ø 6 F/01

■ **Art. 2698Y**
h. 13,5 x Ø 6 F/01

Serie Pegaso



Art. 1614Y
h. 16 x 8



Art. 2830Y
h. 15,5



Art. 2736Y
h. 20

Art. 7382Y
h. 85 x 22,5 x 8,5

Preferibilmente per
lampade F/03



Art. 2078Y
7 x 9

Art. 2075Y
8 x 10

Art. 2076Y
9 x 12

Art. 2077Y
11 x 15



Art. 138107Y
7 x 9

Art. 1381Y
9 x 12

Art. 1378Y
11 x 15



Art. 2585Y
h. 26 x 15 M/33-B



Art. 2662Y
h. 21 x 13 M/41-8

Art. 2661Y
h. 21 x 13 M/41-8

Adattabile all'accessorio con lucchetto Art. 4000.



Art. 7391YP
h. 12,6 x 4,3
P/A13 (ossario)

(sezione )



Art. 7097Y
h. 10 x 5
P/55 (ossario)

Art. 709717Y
h. 17
P/55 (ossario)



Art. 7067Y
h. 13 x 4,5
P/38 (ossario)

Art. 706717Y
h. 17
P/38 (ossario)

Serie Musa



Art. 2268Y
h. 10,5 x 8 x 7,5
B/11 (ossario)



Art. 2149YP
h. 9 x 8 x 7,5
P/76 (ossario)



Art. 2148Y
h. 12,5 x 8
F/01 (ossario)

new

finitura Nerolucido

FINITURA NEROLUCIDO

- Articoli in bronzo doppia verniciatura a polvere nera a cottura 200°.
- Alta resistenza agli agenti atmosferici.
- Ideali per le zone di mare.
- Testati in laboratorio.
- Garanzia di lunga durata.

NEROLUCIDO FINISH

- Bronze items finished with two coats of black powder varnish and baked at 200°.
- High resistance to weathering.
- Ideal for coastal areas.
- Laboratory tested.
- Long-term guarantee.



A B C D E F G H I
 J K L M N O P Q R
 S T U V W X Y Z
 1 2 3 4 5 6 7 8 9 0 * † ' ° - ∨
 62 63 61 64 76
 68 67

Art. 7651 - h. 1,5
 ● ** ■ Æ Þ Ð Æ Ø

Art. 7652 - h. 2,5
 ● ** Æ Þ Ð Æ Ø

Art. 7653 - h. 3
 ● ** Æ Þ Ð Æ Ø

Art. 7654 - h. 4
 ● Æ Þ Ð Æ Ø

Art. 7655 - h. 5
 ● Æ Þ Ð Æ Ø

’ ° - ∨

Art. 7656 - h. 1,5-2,5-3-4-5

Legenda simboli: ● Lettere / * Numeri / ✱ Stelle (70) - Croci (69) / ■ Stelle (68) - Croci (67) - Æ (65) - Þ (59) - Ð (71) - Æ (72) - Ø (73)
 Symbols: ● Letters / * Figures / ✱ Stelle (70) - Croci (69) / ■ Stelle (68) - Croci (67) - Æ (65) - Þ (59) - Ð (71) - Æ (72) - Ø (73)

Art. 7290NL - h. 1,5

Art. 7291NL - h. 2

Art. 7292NL - h. 2,5

Art. 7293NL - h. 3

Art. 7294NL - h. 4

Art. 7295NL - h. 5

Art. 7296NL - h. 6

Art. 7297NL - h. 8

Art. 7298NL - h. 10

A B C D E F G H I J

K L M N O P Q R S

T U V W X Y Z

a b c d e f g h i j k l m

n o p q r s t u v w x z

* † n. m. 1 2 3 4 5 6 7 8 9 0

’ ° - ∨

Art. 7299NL - Segni

’ ° - ∨ . /
 62 64 76 61 63



Art. 2078NL Art. 2077NL
7 x 9 11 x 15

Art. 2075NL Art. 2094NL
8 x 10 13 x 18

Art. 2076NL Art. 2095NL
9 x 12 18 x 24



Art. 138107NL
7 x 9

Art. 1381NL
9 x 12

Art. 1382NL
10 x 15

Art. 1378NL
11 x 15

Art. 1377NL
13 x 18



Art. 1663NL
9 x 12

Art. 1664NL
11 x 15

Art. 1945NL
13 x 18

Art. 1954NL
18 x 24



Art. 1566NL
9 x 12

Art. 1567NL
10 x 15

Art. 1941NL
13 x 18



Art. 294508NLU
8 x 10

Art. 2945NLU
9 x 12

Art. 2946NLU
11 x 15



Art. 294907NLU
7 x 9

Art. 2949NLU
9 x 12

Art. 2948NLU
10 x 15



Art. 2955NLU
9 x 12

Art. 2956NLU
11 x 15



Art. 2959NLU
9 x 12

Art. 2960NLU
10 x 15



Art. 2938NLU
9 x 12

Art. 2939NLU
11 x 15



Art. 2075U
8 x 10

Art. 2076U
9 x 12

Art. 2077U
11 x 15

Art. 2094U
13 x 18



Art. 1381U
9 x 12

Art. 1382U
10 x 15

Art. 1377U
13 x 18

FINITURA DORATA



■ Art. 7087NLP
h. 14 x 9 x 9 P/50

■ Art. 7089NLP
h. 14 x 9 P/50



■ Art. 7086NL
h. 15 x 8 x 8 F/01

■ Art. 7088NL
h. 15 x 8 F/01



■ Art. 733713NLP
h. 13,5 x 7 x 7,5 P/50

■ Art. 734413NLP
h. 13,5 x 7 P/50



■ Art. 733914NL
h. 14 x 8 x 8,5 F/01

■ Art. 734514NL
h. 14 x 8 F/01



■ Art. 753913NLP
h. 12 x 6,5 x 7 P/A11

■ Art. 754413NLP
h. 12 x 6,5 P/A11



■ Art. 754014NL
h. 14 x 7 x 7,5 F/01

■ Art. 754514NL
h. 14 x 7 F/01



■ Art. 7431NLP
h. 12 x 6 x 6,5 P/43**Y

■ Art. 7432NLP
h. 12 x 6 P/43**Y



■ Art. 7433NL
h. 14 x 6 x 7 F/01

■ Art. 7434NL
h. 14 x 6 F/01



■ Art. 2638NLP
h. 11,5 x 6 x 5 P/43**Y

■ Art. 2697NLP
h. 11,5 x Ø 6 P/43**Y



■ Art. 2641NL
h. 13,5 x Ø 6 F/01

■ Art. 2698NL
h. 13,5 x Ø 6 F/01

new

nerolucido

Serie Global



Art. 7417NL
h. 20,5 x 9,5 x 10
F/12



Art. 7488NL
h. 20,5 x 9,5 x 10
F/12

Art. 7410NLP
h. 20,5 x 13 x 14
P/72-CY

Art. 7543NLP
h. 20,5 x 13
P/72-CY



Art. 7408NLP
h. 19 x 20 x 15
P/A14**Y

Art. 7409NLP
h. 30,5 x 18
P/29**Y

Art. 7483NLP
h. 19 x 20
P/A14**Y



Art. 2982NLP
h. 21 x 13 x 11 P/72



Art. 2983NLU
h. 20 x 10 x 11 F/02

Art. 2969NLP
h. 21 x 13 x 11 P/72

Art. 2970NLU
h. 20 x 10 F/02



Art. 2984NLU
h. 23 x 14 x 14 M/41-8

Art. 2971NLU
h. 23 x 14 M/41-8

Art. 29Y9NLU
h. 26 x 17 M/57



Art. 2985NLP
h. 18 x 20 x 15 P/70**N

Art. 2958NLP
h. 18 x 20 P/70**N



Art. 2942NLU
h. 24 x 14

new

nerolucido

Serie Luna Oro



Art. 2933NLU
h. 20 x 10 x 11
F/02

Art. 2929NLU
h. 20 x 10 x 11
F/02



Art. 2938NLU
9 x 12

Art. 2939NLU
11 x 15



Art. 2931NLU
h. 23 x 14 x 14
M/41-8

Art. 2925NLU
h. 23 x 14 x 14
M/41-8

Art. 2926NLU
h. 26 x 17
M/57



Art. 2937NLPU
h. 18 x 20 x 15
P/70**N

Art. 2936NLPU
h. 18 x 20
P/70**N



Art. 2932NLPU
h. 21 x 13 x 11
P/72

Art. 2927NLPU
h. 21 x 13 x 11
P/72



Art. 2935NLPU
h. 18 x 30
P/A73

Art. 2934NLPU
h. 18 x 30
P/A73

Art. 2928NLPU
h. 29 x 17
P/59-DN

Lampade Universali



Art. 2662NL
h. 21 x 13 M/41-8



Art. 2585NL
h. 26 x 14 M/33-B

Art. 2661NL
h. 21 x 13 M/41-8

Adattabile all'accessorio con lucchetto Art. 4000.

Per un maggior mantenimento nel tempo delle nostre lampade a cera consigliamo l'utilizzo dei nostri ceri a batteria Aethernum (vedi pag. 458).





Art. 2736NL
h. 20



Art. 2830NL
h. 15,5



Art. 2642NL
h. 29 x 12



Art. 2649NL
h. 21



Art. 2942NLU
h. 24 x 14



Art. 1614NL
h. 16 x 8



(sezione ■)

Art. 1762NL
h. 15 x 6,5

Art. 1763NL
h. 20 x 9

Art. 1764NL
h. 25 x 9

LED LIGHT SOLUTION
AETERNUM

CANDELE CON EFFETTO FIAMMA VERA



Candele Led a lunga durata.
Senza cera, non producono fumo,
non riscaldano, non sporcano.



Ogni articolo contiene:

- Candela AETERNUM con Led movimento a fiamma
- 2 pile Alkaline
- Istruzioni

■ ■ Art. 5100
h. 15 x 8

■ ■ Art. 510002
h. 10,5 x 6,5

■ ■ Art. 510003
h. 8 x 3,5



serie Palladio

FINITURA PALLADIO

L'oggetto di bronzo, dopo una preparazione accurata, viene spazzolato e lucidato a specchio. Tutte le lavorazioni vengono eseguite a mano. L'effetto finale si ottiene dopo un bagno galvanico che ne definisce la brillantezza e la costante tonalità dell'effetto acciaio. È inoltre protetto da una vernice trasparente che prolunga la durata del tempo.

PALLADIO FINISH

Bronze items are carefully prepared, then brushed and mirror polished. The final result is achieved by means of a galvanic bath conferring the typical brightness and stainless steel-like effect. Finally the items are protected by transparent varnish in order to extend their lifetime. All of the above processes are completed by hand.



Aa Bb Cc Dd Ee Ff Gg

Hh Ii Jj Kk Ll Mm Nn

Oo Pp Qq Rr Ss Tt Uu Vv

Ww Xx Yy Zz Ll ⁷²

abcdefghijklmnopqrstuvwxyz

qrstuvwxyzæ ⁷²

0123456789 n m A Ω * * †
66 33 68 70 67



Sistema di montaggio

Art. 7376 - h. 6
maiuscole

Art. 7377 - h. 2,7
minuscole

Art. 7378 - h. 2,7
lettere terminali

Art. 7379 - h. 2,7
Numeri e lettere
con perni

Iniziale minuscola



77



77 60 61 76 64 63 62

Art. 7384
segni

1234567890

n m A Ω * * †
66 33 68 70 67

Art. 7380 - h. 2,7
Numeri e lettere
avvitabili su barretta



Art. 7421H

cm.10 - max 4 alloggi

Art. 7422H

cm.17 - max 6 alloggi

Art. 7423H

cm.27 - max 10 alloggi

Art. 7424H

cm.29,5 - max 11 alloggi

Art. 7425H

cm.32 - max 12 alloggi

Per esempi di composizione delle barrette e misure d'ingombro vedi pag. 2/3 (bronzo).

A B C D E F G

Art. 7340 - h. 2,5
●** ÆÐŁŒ

H K I J L M N

Art. 7341 - h. 3
●** ÆÐŁŒ

O P Q R S T U

Art. 7342 - h. 4
● ÆÐŁŒ

V W X Y Z

Art. 7343 - h. 5
● ÆÐŁŒ

1 2 3 4 5 6 7 8 9 0

᠑ ᠒ ᠓ ᠔ ᠕
Art. 7225 - segni

᠖ ᠗ ᠘ ᠙ ᠚ ᠛ ᠜

62 63 61 64 76 70 67

Per quantità inferiori alla confezione e forniture di dicitura, aumento del 20%.
Legenda simboli: ● Lettere / * Numeri / ✱ Stelle - Croci - Æ (65) - Þ (59) - Ð (71) - Ł (72) - Œ (73)

20% surcharge for any order less than the minimum requirement and for specific words.
Symbols: ● Letters / * Figures / ✱ Stars - Crosses - Æ (65) - Þ (59) - Ð (71) - Ł (72) - Œ (73)

A B C D E F G

Art. 7313H - h. 1,5

H K L J L M

Art. 7314H - h. 2

N O P Q R S T

Art. 7315H - h. 2,5

U V W X Y Z

Art. 7316H - h. 3

1 2 3 4 5 6 7 8 9 0

Art. 7317H - h. 4

✱ † N . M. ᠑ ᠒ ᠓ ᠔ ᠕

Art. 7318H - h. 5

Art. 7319H - h. 6

Art. 7320H - h. 8

Art. 7321H - h. 10

Art. 7325H - segni

70 67 62 63 64 61 76

Art. 7290H - h. 1,5

Art. 7291H - h. 2

Art. 7292H - h. 2,5

Art. 7293H - h. 3

Art. 7294H - h. 4

Art. 7295H - h. 5

Art. 7296H - h. 6

Art. 7297H - h. 8

Art. 7298H - h. 10

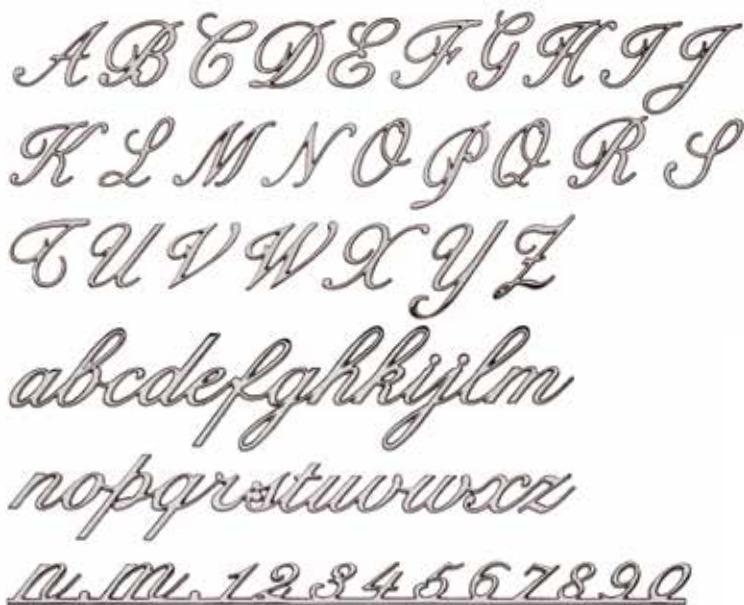

70 67



Art. 7299H - segni



62 64 76 61 63

Nelle ordinazioni indicare sempre l'altezza della vocale minuscola. Il prezzo verrà calcolato in base all'altezza della vocale minuscola.

A richiesta si forniscono numeri sciolti: uguale prezzo.

Spessore mm 3. Per spessore superiore a mm 3 chiedere preventivo.

The height of the small letters must always be mentioned on the order. The price will be calculated on this basis.

Loose numbers (not on a bar) are available upon request at same price.

Thickness 3 mm. For extra thickness please ask for a quote.



■ Art. 101101H
h. 25 x 15 x 15
M/81-L M/81-P



■ Art. 101104H
h. 21 x 14 x 14
M/82-L M/82-P

■ Art. 101105H
h. 25 x 15 x 15
M/84-L M/84-P



Art. 7253HR
h. 20 x 13 x 12 R/93-AH



Art. 7259HR
h. 19,5 x 19 x 12,5 R/A3H



Art. 7261H
h. 22 x 14 x 13 M/41-8

Art. 7254HR
h. 20 x 13 x 11 R/93-AH

Art. 7260HR
h. 19,5 x 19 x 12,5 R/A3H

Art. 7262H
h. 22 x 14 x 12 M/41-8

Art. 7255HR
h. 31 x 17,5 x 16 R/B3H



Art. 7256H
h. 21 x 10 x 10 F/12

Art. 7257H
h. 21 x 10 x 9 F/12

Art. 7258H
h. 25 x 11 x 11 F/03



Art. 7181HR
h. 10 x 10 x 9 R/01

Art. 7182HR
h. 10 x 9,5 x 9 R/01

Art. 7183HR
h. 13 x 11 x 11 R/B4



Art. 7033H
9 x 12

Art. 7034H
11 x 15



Art. 7024H
9 x 12

Art. 7025H
10 x 15



Art. 7062H
9 x 12

Art. 7063H
11 x 15



Art. 7016H
9 x 12

Art. 7017H
10 x 15



Art. 7242HR
h. 20,5 x 12 x 12,5 R/93-AH



Art. 7250HP
h. 17 x 27 x 11 P/A74

(sezione)



Art. 7248HR
h. 19 x 16 x 11,5 R/77**H

Art. 7243HR
h. 20,5 x 12 R/93-AH

Art. 7249HR
h. 19 x 16 x 11 R/77**H

Art. 7244HR
h. 29 x 15,5 R/88**H



Art. 7251H
h. 23 x 14 x 14,5 M/41-8



Art. 7245H
h. 20 x 10 x 10,5 F/12



Art. 7041HR
h. 10 x 10 R/87

Art. 7252H
h. 23 x 14 M/41-8

Art. 7246H
h. 20 x 10 F/12

Art. 7042HR
h. 10 x 9 R/87

Art. 7247H
h. 27 x 11,5 F/03

Art. 7043HR
h. 13 x 11 R/84



Art. 7349H
9 x 12



Art. 7347H
10 x 15



Art. 7355H
9 x 12



Art. 7352H
9 x 12

Art. 7350H
11 x 15

Art. 7346H
9 x 12

Art. 7356H
11 x 15

Art. 7353H
10 x 15



Art. 1649H
h. 13

Art. 2740H
h. 21



Art. 1401H
h. 11,5

Art. 1376H
h. 18



Art. 2735H
h. 10

Art. 2736H
h. 20



Art. 7166H
h. 15 x 10



Art. 7167H
h. 14,5 x 9

Art. 2743H
h. 14



Art. 1761H
h. 12 x 7
5,5 x 12 mm

Art. 1763H
h. 20 x 9
6 x 14 mm



Art. 1910H
h. 26 x 18



Art. 1540H
h. 14 x 10

Art. 1911H
h. 29 x 20



Art. 7264H
h. 16 x 9

Art. 7266H
h. 30 x 14

Art. 7265H
h. 20 x 11

Art. 7267H
h. 40 x 18

CHIAVARDE PORTANTI per spessore marmo da mm 9 a mm 22 - Con perno 8MA inox V/81 **incluso nel prezzo**



Art. 716308H



Art. 716408H

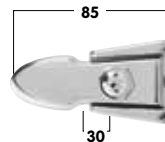

Art. 716508H

CHIAVARDE PORTANTI per spessore marmo da mm 18 a mm 22 - con perno 8 MA inox V/91F **incluso nel prezzo**

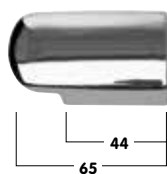

Art. 2911H
mm. 44

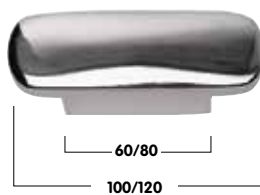

Art. 2910H
mm. 60

Art. 2908H
mm. 80



Art. 1159H
h. 2,5

Art. 1148H
h. 4

Art. 1146H
h. 3

***Art. 1149H**
h. 5



***Art. 1239H**
Ø 4

Le borchie vengono fornite con perno V/01 da mm. 50 passo 5 MA, salvo diversa descrizione. In caso di sostituzione del perno, quello in dotazione verrà valutato al prezzo di listino.

*** A richiesta possono essere fornite con perno fino a 10 MA.**

Acciaio Inox

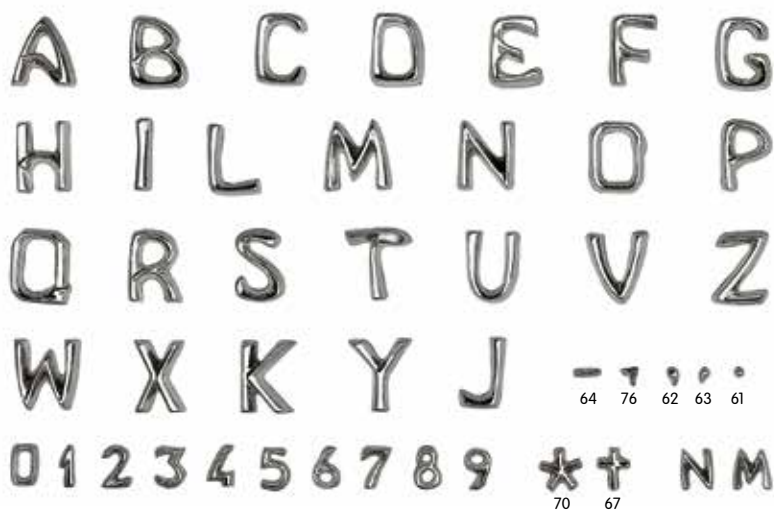

Art. 099001 ■■
h. 195 x 137 x 95

Art. 0131 - h. 2,5
●**Art. 0133 - h. 4
●, e - v
Art. 0135
●
Art. 0019Art. 0382 - h. 5
maiuscoleArt. 0383 - h. 2,5
minuscoleArt. 0380 - h. 2,5
numeri M N
vocali sciolte * +Art. 0378 - h. 2,5
vocali terminali, e - v
Art. 0384●
Art. 0019

A B C D E F G H I L M N O

P Q R S T U V Z W X K Y J

1 2 3 4 5 6 7 8 9 0 ★ † - ∨ ∩ ∙
70 67 64 76 63 62 61

Art. 0005 - h. 2,5
● * * +

Art. 0006 - h. 3
● *

Art. 0007 - h. 4
●

Art. 0008 - h. 5
●

∩ ∙ - ∨
Art. 0019

A B C D E F G H I L

M N O P Q R S T U V

Z W X K Y J Æ Þ Ð Æ Ø
65 59 71 72 73

1 2 3 4 5 6 7 8 9 0 ★ ✱ Α Ω - ∨ ∩ ∙
70 69 66 33 64 76 63 62 61

Art. 0009 - h. 2
● * Æ Þ Ð Ø

Art. 0010 - h. 2,5
● * * + Æ Þ Ð Ø

Art. 0011 - h. 3,5
● * * + Æ Þ Ð Ø

Art. 0012 - h. 4,5
● Ð Æ

Art. 0013 - h. 5,5
● * Ð Æ

Art. 0014 - h. 8
● *

Art. 0015 - h. 12,5
●

∩ ∙ - ∨
Art. 0019
h. 2 - 2,5 - 3,5 - 4,5 - 5,5

Art. 0020 - h. 8 - 12,5

A B C D E F G H I L M N O

P Q R S T U V Z W X K Y J

1 2 3 4 5 6 7 8 9 0 ☆ † - ∨ ∩ ∪

70 67 64 76 62 63 61

Art. 0001 - h. 2,5
●**Art. 0002 - h. 3
●*Art. 0003 - h. 4
●Art. 0004 - h. 5
●

, e • - ∨

Art. 0019

A B C D E F G H I L M

N O P Q R S T U V Z

W X K Y J

A	Ω	☆	✠
66	33	70	69

1 2 3 4 5 6 7 8 9 0 - ∨ ∩ ∪

64 76 63 62 61

Art. 0024 - h. 2,5
●*Art. 0010 - h. 2,5
**+Art. 0025 - h. 3,5
●*Art. 0011 - h. 3,5
**+Art. 0023 - h. 4,5
●Art. 0026 - h. 6
●

, e • - ∨

Art. 0019

A B C D E F G
 H I J K L M N
 O P Q R S T U V
 Y Z W X

Art. 0028
h. 2
 Art. 0029
h. 2,5
 Art. 0030
h. 3
 Art. 0031
h. 4
 Art. 0032
h. 5
 Art. 0033
h. 6
 Art. 0034
h. 7

abcdefghijklmnop
 qrstuvwxyz
 n 13254 m 97680

• • • - v
 Art. 0035

Le misure dei numeri sono comprensive dell'asta.

★ †
 70 67

Nelle ordinazioni indicare sempre l'altezza della vocale minuscola. Il prezzo verrà calcolato in base all'altezza della vocale minuscola.
 A richiesta si forniscono numeri sciolti: uguale prezzo. Spessore mm 1,5. Per spessore superiore, massimo fino a mm 6, chiedere preventivo.
The height of the small letters must always be mentioned on the order. The price will be calculated on this basis
 Loose numbers (not on a bar) are available upon request at same price. Thickness 1,5 mm. For extra thickness, up to max 6 mm, please ask for a quote.

Α Β Γ Δ Ε Ζ Η Θ Ι Κ Λ Μ
 10 11 12 13 14 15 16 17 18 19 20 21

Ν Ξ Ο Π Ρ Σ Τ Υ Φ Χ Ψ Ω
 22 23 24 25 26 27 28 29 30 31 32 33

1 2 3 4 5 6 7 8 9 0 ★ ✕ - v , , •
 70 69 64 76 63 62 61

Art. 0010 - h. 2,5
 ●*✕+

Art. 0023 - h. 4,5
 ●+

• • • - v
 Art. 0019

Per quantità inferiori alla confezione e forniture di dicitura, aumento del 20% .
 Legenda simboli: ● Lettere / * Numeri / ✕ Stelle - Croci / + Alpha - Omega

20% surcharge for any order less than the minimum requirement and for specific words.
 Symbols: ● Letters / * Figures / ✕ Stars - Crosses / + Alpha - Omega

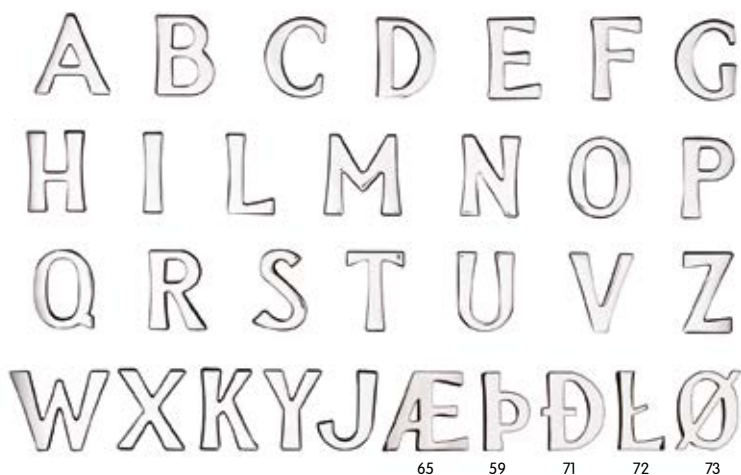

Adesive



LUCIDE

Spessore mm 2,5

Art. 0064 - h. 2,5

●**ÆÐÐØ

Art. 0093 - h. 3,5

●**ÆÐÐØ

Art. 0065 - h. 4,5

●ÆÐÐØ

Art. 0094 - h. 5,5

●ÆÐÐØ

☉ ● ● - ▽

Art. 0066

SATINATE new

Spessore mm 2,5

Art. 0564 - h. 2,5

●**ÆÐÐØ

Art. 0593 - h. 3,5

●**ÆÐÐØ

Art. 0565 - h. 4,5

●ÆÐÐØ

☉ ● ● - ▽

Art. 0566

Con perni



LUCIDE

Spessore mm 2,5

Art. 0073 - h. 2,5

●**ÆÐÐØ

Art. 0095 - h. 3,5

●**ÆÐÐØ

Art. 0074 - h. 4,5

●ÆÐÐØ

Art. 0096 - h. 5,5

●ÆÐÐØ

☉ ● ● - ▽

Art. 0092

h. 2,5 - 3,5 - 4,5 - 5,5

LUCIDE

Spessore mm 3

Art. 0018 - h. 7

●ÆÐÐØ

Art. 0098 - h. 8

●ÆÐÐØ

Art. 0099 - h. 10

●ÆÐÐØ

Art. 0107 - h. 12

●ÆÐÐØ

Art. 0109 - h. 15

●ÆÐÐØ

☉ ● ● - ▽

Art. 0110

h. 7 - 8 - 10 - 12 - 15

Per le misure non indicate chiedere preventivo.

Legenda simboli: ● Lettere / * Numeri / ✱ Stelle - Croci
Symbols: ● Letters / * Figures / ✱ Stars - Crosses

*Targa in metallo autoadesivo o con fori passanti

Art. 4997

h. 2,5 x 6,5

a richiesta si forniscono altre misure (chiedere preventivo)

Art. 4997/A

h. 2 x 7

PEZZI	500	1000	1500	2000
SCONTO	PREZZO INTERO	-15%	-20%	-25%



Art. 0858
h. 7,9 x 12,9

Art. 0864
h. 12,2 x 16,5

Art. 0865
h. 16 x 25

Art. 0866
h. 18 x 28,8

DISPONIBILI A TERRENO - CHIEDERE PREVENTIVO



Art. 0913
h. 25,5 x 34,5

Incisione gratuita · Free Engraving Tipo "CD" *Abcdef* Tipo "BW" ABCDEFG Tipo "BL" ABCDEF Tipo "BS" ABCDEFGH



Art. 0623
9 x 12



Art. 0627
9 x 12



Art. 0629
9 x 12
Art. 0620
10 x 15



Art. 0067
8 x 10

Art. 0070
11 x 15



Art. 0037
6 x 8

Art. 0040
9 x 12

Art. 0043
18 x 24



Art. 0058
8 x 10

Art. 0061
13 x 18

Art. 0068
9 x 12

Art. 0071
13 x 18

Art. 0038
7 x 9

Art. 0041
11 x 15

Art. 0059
9 x 12

Art. 0069
10 x 15

Art. 0072
18 x 24

Art. 0039
8 x 10

Art. 0042
13 x 18

Art. 0060
10 x 15



Art. 0103
9 x 12



Art. 0076
7 x 9

Art. 0079
11 x 15

Art. 0077
8 x 10

Art. 0080
13 x 18

Art. 0078
9 x 12



Art. 0082
9 x 12

Art. 0083
11 x 15



Art. 0167
9 x 12

Art. 0168
10 x 15



Art. 0165
9 x 12

Art. 0166
11 x 15



Art. 0521
9 x 12

Art. 0519
11 x 15



Art. 0085
9 x 12

Art. 0086
10 x 15

Art. 0087
11 x 15

Art. 0088
13 x 18



Art. 0260
9 x 12

Art. 0261
11 x 15



Art. 0258
9 x 12

Art. 0259
10 x 15



Art. 0240
9 x 12

Art. 0241
10 x 15



Art. 0237
9 x 12

Art. 0238
11 x 15



Art. 023701 new
9 x 12

Art. 023801 new
11 x 15



Art. 024001 new
9 x 12

Art. 024101 new
10 x 15

■ ■ Cornici con inclinazione a 30°



Art. 0209
9 x 12 ref. 0068



Art. 0128
9 x 12 ovale 0040

Art. 0129
11 x 15 ovale 0041



Art. 0628 ■ ■
9 x 12
Acciaio inox microfuso



Art. 0143
9 x 12

Art. 0144
11 x 15



Art. 0044
6 x 8

Art. 0045
7 x 9

Art. 0046
8 x 10



Art. 0047
9 x 12

Art. 0048
11 x 15

Art. 0049
13 x 18

Art. 0054
7 x 9

Art. 0055
8 x 10

Art. 0056
9 x 12

Art. 0057
11 x 15



Art. 0044SAT
6 x 8

Art. 0045SAT
7 x 9

Art. 0046SAT
8 x 10

Art. 0047SAT
9 x 12

CHIAVARDE PORTANTI per spessore marmo da mm 18 a mm 22 - con perno 8 MA inox V/91F **incluso nel prezzo**



Art. 0452
mm. 44

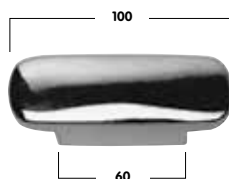

Art. 0451
mm. 60



Art. 0203
Distanziatore
per chiavarda

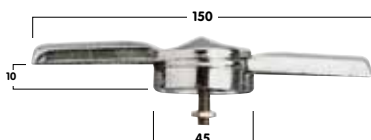

Art. 0202

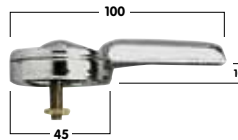

Art. 0212

PORTANTE



Art. 0414
Ø 4,8

Con perno
Inox 8 MA x 100 per
spessore mm.20/30

Con perno 6 MA x 50 inox incluso nel prezzo - per marmo mm. 10
Per marmo mm. 20 aggiungere art. 0203



Art. 0376
h. 10 x 10 - cornice per riquadro loculi regolabile in
altezza e larghezza

Art. 037601
el. lineare cm 40 x riquadro loculo cm 60

Art. 037602
el. lineare cm 45 x riquadro loculo cm 65

Art. 037603
el. lineare cm 50 x riquadro loculo cm 70

Art. 037604
el. lineare cm 55 x riquadro loculo cm 75

Art. 037609
el. lineare a cm x riquadro loculo



Art. 0189
h. 2,5

Art. 0192
h. 4,5

Art. 0190
h. 3,5

Art. 0193
h. 5,5

Art. 0191
h. 4



Art. 0175
Ø 2,5

Art. 0176
Ø 3,5

Art. 0177
Ø 4,5



Art. 0183
Ø 1,5

Art. 0184
Ø 2

Art. 0185
Ø 2,5

Art. 0186
Ø 3,5

Art. 0187
Ø 4,5



Art. 0169
h. 3,5 (senza perno)



Art. 0174
Ø 3,5 (senza perno)



Art. 0173
Ø 3,5 (senza perno)



Art. 0178 Ø 3,5

Art. 0179 Ø 4,5

Art. 0180 Ø 5

Art. 0181 Ø 5,5



Art. 0195
h. 4

Art. 0196
h. 5

SISTEMA DI SOLLEVAMENTO



Anellone alzasigilli

Art. 0017 Ø 10
con perno acciaio inox 14 MA x 190 -



Anellone pesante
Art. 0919
Ø 12,5 - Borchia 8 x 8



Anellone pesante
Art. 0920
Ø 9 - Borchia Ø 7,5



Art. 0921
Ø 10
Borchia 4,5 x 4,5



Anellone pesante
● mm 8 ● mm 10
Art. 009708 **Art. 009710**
Ø 8,5 Ø 9
Borchia Ø 5 Borchia Ø 5,5

Con perno
acciaio inox
8MA

Con perno
acciaio inox
10MA

Le borchie vengono fornite con perno V/01 da mm. 50 passo 5 MA.
In caso di sostituzione del perno, quello in dotazione verrà valutato al prezzo di listino.

● ■ ■ Materiale massiccio · Solid stainless steel



Art. 0939
h. 29 x 49,5 x 9 I/12 F/02
monoblocco

Art. 0260
9 x 12 cornice



Art. 0940
h. 19 x 49,5 x 9 I/12 M/54
monoblocco

Art. 0258
9 x 12 cornice



Art. 0925
h. 29 x 49,5 x 9 I/12 F/02
monoblocco

Art. 0260
9 x 12 cornice



Art. 0930
h. 19 x 49,5 x 9 I/12 M/54
monoblocco

Art. 0258
9 x 12 cornice



Art. 0943
h. 14,5 x 54,5 - monoplacca con incisione



Art. 0944
h. 21,5 x 54 - monoplacca con incisione



Art. 0807
h. 35 x 65 P/85 F/02

Art. 1947
9 x 12 cornice



Art. 0806
h. 22 x 58 P/72-A F/02 monoblocco

Art. 0521
9 x 12 cornice



Art. 0593
h. 13 F/01



Art. 0591
h. 13 P/43ACUT



Art. 0593SAT
h. 13 F/01



Art. 0591SAT
h. 13 P/43ACUT

Art. 0594
h. 17 F/12

Art. 0592
h. 16 P/65ACUT

Art. 0594SAT
h. 17 F/12

Art. 0592SAT
h. 16 P/65ACUT



Art. 0598
h. 13 F/01



Art. 0597
h. 16 P/65ACUT



Art. 0596
h. 13 P/12



Art. 0598SAT
h. 13 F/01



Art. 0597SAT
h. 16 P/65ACUT



Art. 0596SAT
h. 13 P/12

Art. 0601
h. 17 F/12

Art. 0601SAT
h. 17 F/12



Art. 0257
h. 9 P/A19CUT



Art. 0256
h. 12 P/A19CUT



Art. 0257SAT
h. 9 P/A19CUT



Art. 0256SAT
h. 12 P/A19CUT



Art. 0468
h. 12 x 5,5 P/55



Art. 0470
h. 7 x 5 x 5,5



Art. 0470W
h. 7 x 5 x 5,5



Art. 0470WSAT
h. 7 x 5 x 5,5



Art. 0468SAT
h. 12 x 5,5 P/55



Art. 0467
h. 11 x 7,5 P/75



Art. 0469
h. 11 x 7,5 F/01



Art. 0283
h. 8 x 10
R/72N

Art. 0284
h. 8 x 10
R/72N



Art. 0469SAT
h. 11 x 7,5 F/01



Art. 046201SAT
h. 13 x 6,5 P/75



Art. 0483
h. 9 P/A7



Art. 0480
h. 12 P/A7



Art. 0483SAT
h. 9 P/A7



Art. 0480SAT
h. 12 P/A7



Art. 0465
h. 10 x 5 P/55



Art. 0466
h. 11 x 6 P/75



Art. 0466SAT
h. 11 x 6 P/75



Art. 0264
h. 13 x 4,5
P/38GR



Art. 0264SAT
h. 13 x 4,5 P/38GR



Art. 0461AGSAT
h. 13 x 4,9 P/75

Art. 0461
h. 13 x 4,5 P/75

Art. 0461SAT
h. 13 x 4,5 P/75

Con adesivo chiedere preventivo.





Art. 0835 (ossario)
h. 13 x 7,5 x 6 P/84



Art. 0834 (ossario)
h. 13 x 7,5 F/01

Art. 0476
h. 18 x 10 x 8 P/64

Art. 0464
h. 19 x 10 x 8 F/02

Art. 0742
h. 18,5 x 10 x 7 P/64

Art. 0685
h. 19 x 10 x 7 F/02



Art. 0837 (ossario)
h. 13 x 7,5 x 6,5 P/84



Art. 0836 (ossario)
h. 13 x 7,5 x 6,5 F/01

Art. 0475
h. 18 x 10 x 8,5 P/64

Art. 0463
h. 19 x 10 x 8,5 F/02

Art. 0741
h. 18,5 x 10 x 7,5 P/64

Art. 0684
h. 19 x 10 x 7,5 F/02

Serie Bouquet



Art. 0121 P
h. 8 x 4,7 x 5,3 P/A8



Art. 0484
h. 14 x 7,5 x 10 P/05



Art. 0494
h. 11 x 7 x 5 P/A7



Art. 0488
h. 13 x 7 x 8,5 P/10

Art. 0489
h. 16 x 8 x 9 P/04



Art. 0432
h. 14,5 x 6,5 x 8 B/06



Art. 0435
h. 15 x 9 x 10 B/04



Art. 0392
h. 13,5 x 6,5 x 8 F/01



Art. 0369
h. 14 x 7 x 8 F/01



Art. 0539
h. 12 x 35 x 8 P/25**

(sezione ☺)



Art. 0542
h. 13 x 22 x 7,5 P/26**

(sezione ☺)



Art. 0543
h. 13 x 25 x 8 P/27**

(sezione ☺)



Art. 0122SAT
h. 13,5 x 6 P/50



Art. 0123SAT
h. 14 x 9 M/98



Art. 0124SAT new
h. 14 P/50 M/98

Art. 0125SAT new
h. 14 P/50 M/98



Art. 0117SAT
h. 17 P/2802



Art. 0116SAT
h. 16,5 M/94

Art. 0116
h. 16,5 M/94



Art. 0800SAT
h. 20 R/61N



Art. 0134SAT 1
h. 18,5 MI38-8



Art. 0114SAT
h. 24 P/7201



Art. 0113MSAT
h. 23 M/60-8



Art. 0364
h. 25 x 10 P/89**H



Art. 0130
h. 23 x 12,5 M/80

Art. 0364SAT new
h. 25 x 10 P/89**H

Art. 0130SAT new
h. 23 x 12,5 M/80



■ Art. 0588
h. 20,5 x 11 P/2801

■ Art. 0590
h. 20,5 x 10,5 P/2801



■ Art. 0587
h. 20 x 9 F/02

■ Art. 0589
h. 20 x 8,5 F/02



■ Art. 023301 new
h. 19 x 12 x 9 I/11

■ Art. 023401 new
h. 19 x 12 x 8 I/11



■ Art. 023501 new
h. 18 x 11 x 7 F/02

■ Art. 023601 new
h. 18 x 11 F/02



■ Art. 002228 ■■
h. 28 P/7201



■ Art. 0021M ■■
h. 23 M/93BD



■ Art. 0319
h. 19 x 12,5 x 7,5 I/06

■ Art. 0320
h. 19 x 12,5 x 7,5 I/06



■ Art. 0321
h. 18,5 x 10 x 8 F/02

■ Art. 0359
h. 18,5 x 10 x 8 F/02



■ Art. 0426
h. 18 x 12 x 8,5 I/01

■ Art. 0430
h. 18 x 12 x 7,5 I/01



■ Art. 0423
h. 18 x 10,5 x 8,5 F/02

■ Art. 0425
h. 18 x 10,5 x 7 F/02



■ Art. 0433
h. 14 x 16,5 M/06-P

■ Art. 0434
h. 14 x 16,5 M/06-P



■ **Art. 0546**
h. 21 x 11 x 13,5
P/72**H

■ **Art. 0548**
h. 21 x 11 x 12
P/72**H



■ **Art. 0545**
h. 21 x 9 x 11
F/02

■ **Art. 0547**
h. 21 x 9 x 9,5
F/02

Serie Bois Inox



■ **Art. 0799 R**
h. 20 x 12 R/61N

■ **Art. 0800 R**
h. 20 x 12 R/61N

Art. 0832 R
h. 30 x 15 R/92



■ **Art. 0826**
h. 20 x 10 F/02

■ **Art. 0827**
h. 20 x 10 F/02

Art. 0833
h. 25 x 11 F/03



■ **Art. 0612 R**
h. 17 x 32 x 12 R/71**N
(sezione ☺)



■ **Art. 0615 R**
h. 15 x 20 x 9
R/71-AN
(sezione ☺)



■ **Art. 0616 R**
h. 20 x 13 x 9
R/25-N

■ *Serie Torciglione*
acciaio inox microfuso



■ **Art. 0617**
h. 20 x 9 F/02



■ **Art. 0629**
9 x 12

Art. 0620
10 x 15



■ **Art. 0623**
9 x 12



■ **Art. 0618**
h. 16 x 8

Art. 0619
h. 23 x 12



Art. 0308
h. 29 x 14 x 12 I/05



Art. 0291
h. 19 x 12,5 x 7,5 I/01



Art. 0362
h. 7 x 13 incasso Ø 10 I/05



Art. 0290
h. 17,5 x 10 x 8 F/02

Art. 0249
h. 17,5 x 10 x 8 F/02



Art. 0258
9 x 12

Art. 0259
10 x 15



Art. 0260
9 x 12

Art. 0261
11 x 15



Art. 0297
h. 14 x 16,5 x 10
M/06-P



Art. 0292
h. 16,5 x 22,5 x 8,5 I/07



Art. 030401
h. 27,5 x 10 x 10 P/89**H



Art. 0334
h. 24,5 x 11,5 x 12 M/31
Apertura laterale

Art. 0304
h. 26 x 10 x 10 P/73**H



Art. 0243
h. 29 x 14 x 12 l/05



Art. 0254
h. 19 x 12,5 x 7,5 l/06



Art. 0253
h. 19 x 10 x 8 F/02

Art. 0242
h. 19 x 12,5 x 7,5 l/06

Art. 0244
h. 19 x 10 x 8 F/02



Art. 0255
h. 14 x 16,5 x 10 M/06-P



Art. 0252
h. 16,5 x 22,5 x 8,5 l/07



■ mm 10 x 10

Art. 024520
h. 20 x 10

Art. 024530
h. 30 x 13

Art. 0245
h. 40 x 20

Art. 0246
h. 50 x 20

● ■ ■■ Materiale massiccio · Solid stainless steel



Art. 044501
h. 28 x 8,5 P/7201

Art. 0445
h. 25,5 x 8,5 P/72**H



Art. 030301
h. 28 x 12 x 8,5
P/7201

Art. 0303
h. 24 x 12 x 8,5
P/7201



Art. 0333
h. 24,5 x 16 x 10,5
apertura laterale
M/31



■ Art. 0471
h. 20 x 10 F/12



■ Art. 0454
h. 20 x 10 P/2801



■ Art. 0459
h. 27,5 x 12
P/59GR**



■ Art. 0460 ■■
h. 29 x 15
R/A10

■ Art. 0473
h. 20 x 9 F/12

■ Art. 0457
h. 20 x 9 P/2801



■ Art. 01382
h. 23 x 11,5 x 12,5
S/26 fumè - L - F - M
2 porte

■ Art. 01381
h. 23 x 11,5 x 12,5
S/26 fumè - L - F
1 porta



■ Art. 01081M
h. 24 x 12 x 11,5
M/32-L-P



■ Art. 0730
h. 32 x 17 M/04

(sezione □)



■ Art. 0775
h. 25 x 14 M/04

(sezione △)



■ Art. 0862
h. 25,5 x 16 M/35



■ Art. 0119MSAT new
h. 18 M/94



■ Art. 0126MSAT new
h. 22 x 13 M/93
doppia apertura



■ Art. 0839
h. 24 x 14 M/29L



■ Art. 0327
h. 24 x 13 x 13
M/31L



■ Art. 0311
h. 23,5x 12,5 x 12,5
M/57



■ Art. 0862/E ◆
h. 24 x 16
M/35 - F/02L



■ Art. 0730/E ◆
h. 30 x 17 M/04 - F/02L



■ Art. 0449
h. 19 Base Ø 8 F/02



■ Art. 0431
h. 22,5 Base Ø 8 P/07



■ Art. 0735
h. 16 x 9 x 8,5 F/02



■ Art. 0722
h. 20 x 9 x 12 P/07



■ Art. 0621 R
h. 19 x 19 x 13 R/A3



■ Art. 0628
9 x 12



■ Art. 0622
h. 20 x 11 x 9 F/02



■ Art. 0537
h. 19,5 x 14 x 9
P/85



■ Art. 0801
h. 20,5 x 14 x 8
P/85

■ Art. 0534
h. 19,5 x 14 x 9
P/85

■ Art. 0804
h. 20,5 x 14 x 8
P/85



■ Art. 0538
h. 19 x 9 x 8
F/02

■ Art. 0802
h. 20 x 9 x 7
F/02



Art. 0779
h. 20 x 8 x 8,5 P/72-A



Art. 0780
h. 19 x 8 x 8,5 F/02

Serie Sacra Famiglia



Art. 0520
h. 20 x 11 x 9 P/06



Art. 0523
h. 19 x 11 x 9 F/02

acciaio inox

Serie Scrigno



Art. 0505
h. 20 x 12,5 x 9,5
P/77** S/23



Art. 0516
h. 21 x 13 x 8
F/02 S/22

Serie Betlemme



Art. 0577
h. 19 x 11 x 9 P/54



Art. 0266
h. 19 x 11 x 9 F/02

Art. 0509
h. 21,5 x 12,5 x 9,5
P/77** S/23

Art. 0513
h. 22,5 x 13 x 8
F/02 S/22

Art. 0790
h. 19 x 11 x 8 P/54

Art. 0852
h. 19 x 11 x 8 F/02

Serie Armonia



Art. 0438
h. 19 x Ø 9
P/60



Art. 0437
h. 16 x Ø 9
F/02



Art. 0747
h. 21 x Ø 8
P/60

Art. 0748
h. 31 x Ø 11
P/61



Art. 0746
h. 20 x Ø 8
F/02

Art. 0706
h. 28 x Ø 10
F/03

Serie Ottagonale



Art. 07748001
h. 25 x 12,5 M/32-P



Articolo Kosmolux
h. 29,5 x 10,5 x 8



Art. 072918
h. 37 x 18



Art. 072914
h. 32 x 14



Art. 072818
Ø 18



Art. 0731
h. 20 x 18



Art. 0729182
h. 37 x 18



Art. 0729181
h. 37 x 18



Art. 0729142
h. 32 x 14



Art. 0729141
h. 32 x 14



■ **Art. 0817**
h. 7 x Ø 19 P/59GR**



■ **Art. 0278 P**
h. 12 x Ø 19 P/59GR**



■ **Art. 0362**
h. 7 x 13 I/05



■ **Art. 0737**
h. 4,5 x Ø 14,5 P/59GR



■ **Art. 0526**
h. 8 x Ø 18 P/20
incasso Ø 7,5

Art. 0527
Asta h. 21
(cornice esclusa)



■ **Art. 0701**
Ø 6 F/01

Art. 0702
Ø 7 F/02

Art. 0703
Ø 8 F/03



■ **Art. 0279**
h. 14 x Ø 10,5 F/02



■ **Art. 01371SAT**
h. 20,5 Ø 37 P/82



■ **Art. 01361**
h. 20,5 Ø 28,5 P/18



■ **Art. 01362SAT**
h. 22 Ø 36 P/82



Art. 0492
h. 21 x 15 x 10 P/11



Art. 0499
h. 21 x Ø 13 P/14



Art. 0494 **Art. 0496**
h. 11 x 7 x 5 P/A7 h. 20 x 13 x 10 P/11

Art. 0495
h. 17 x 11 x 8 P/12



Art. 0507
h. 19,5 x 11 x 12 P/15



Art. 0488
h. 13 x 7 x 8,5 P/10



Art. 0503
h. 19 x 9 x 11 P/03**



Art. 0486
h. 19 x Ø 10,5 P/08

Art. 0489
h. 16 x 8 x 9 P/04

Art. 0490
h. 19 x 9 x 10 P/08



Art. 0481
h. 19 x 11 x 11 P/03**



Art. 0121 P
h. 8 x 4,7 x 5,3 P/A8



Art. 0427
h. 18 x 8,5 x 10 B/09



Art. 0432
h. 14,5 x 6,5 x 8 B/06

Art. 0484
h. 14 x 7,5 x 10 P/05

Art. 0482
h. 18 x 10 x 11 P/02



Art. 0397
h. 19 x 21 x 10 F/02



Art. 0395
h. 18 x 16 x 11 F/02



Art. 0390
h. 18 x 20 x 9 F/02



Art. 0719
h. 17 x 9 x 10 F/02



Art. 0385
h. 16 x 7 x 8 F/02



Art. 0358
h. 20 x 9 x 11 F/02



Art. 0369
h. 14 x 7 x 8 F/01



Art. 0392
h. 13,5 x 6,5 x 8 F/01

Art. 0394
h. 20 x 10 x 11 F/03

Art. 0370
h. 17 x 8 x 9 F/02

Art. 0393
h. 17 x 9 x 11 F/02



Art. 0420
h. 20 x 11 x 13 B/02



Art. 0429
h. 17 x 11 x 13 B/03



Art. 0435
h. 15 x 9 x 10 B/04



Art. 0528
h. 30 x 11 x 13 BA/1



■ **Art. 0828**
h. 13 x 7 P/10

Art. 0829
h. 19 x 8 P/04

Art. 0830
h. 21 x 9 P/08

Art. 0831
h. 29 x 13 P/01



■ **Art. 0848**
h. 22 x 13 P/11

Art. 0847
h. 18 base 6,5 P/12

Art. 0849
h. 30 x 21 P/20



■ **Art. 0824**
h. 30 x 17 P/01**



■ **Art. 0861**
h. 23 x Ø 13 P/14



■ **Art. 0860**
h. 20,5 x Ø 10,5 P/08



■ **Art. 0798**
h. 32 x 16 P/20**

Art. 0868
h. 29 x Ø 15 P/01



■ **Art. 0859**
h. 21 x 11 P/03**

Art. 0863
h. 30 x 14 P/01**



■ **Art. 0825**
h. 16 x 7,5 P/05

Art. 0823
h. 20 x 10 P/02



■ **Art. 0842**
h. 21 x 9 P/03**



■ **Art. 0821**
h. 19 x 11 P/15



Art. 0815
h. 31 x Ø 11 BA/1



Art. 0743
h. 21 x Ø 11 B/02



Art. 0691
h. 19 x 17 F/02



Art. 0667
h. 19 x 16 F/02



Art. 0655
h. 21 x 9 F/02



Art. 0668
h. 13 x 6,5 F/01



Art. 0679
h. 13 x 7 F/01

Art. 0669
h. 18 x 9 F/02

Art. 0680
h. 16 x 8 F/02



Art. 0884F03
h. 21 F/03



Art. 0884F04
h. 28 F/04

LUCE MODULATA - REAL FLAME EFFECT



Art. 5100
h. 15 x 8

Art. 510002
h. 10,5 x 6,5

Art. 510003
h. 8 x 3,5

Applicabili alle fiamme
F/01 - F/02 - F/12



Art. 0890
h. 90 x Ø 25 F/03

Art. 0892
h. 96 x Ø 32 F/04



Art. 0873
h. 51 x Ø 16 F/03



Art. 0884
h. 88 x Ø 25 F/03



Art. 0609
Ø 6

Prezzo al cm di altezza.
Le colonne di lunghezza
inferiore a 40 cm saranno
conteggiate come 40 cm.



Art. 0626
Terminale

Per ricavare il prezzo della
"colonna con terminale",
sommare il prezzo del ter-
minale Art. 0626 a quello
della colonna desiderata.
I ganci per catena sono
compresi nel prezzo del ter-
minale. Specificare la posi-
zione desiderata.



Art. 0900
maglia 6,5 x 3,2
(prezzo al dm.)



Art. 0899
maglia 5 x 2
(prezzo al dm.)



Art. 0898
Ø 4 - copricentro



Art. 0533/D
46 x 39



Art. 0922
h. 35



Art. 0934
h. 40

Art. 0533/S
46 x 39



Art. 0933
h. 15



Art. 0923
h. 20,5 x 13



Art. 0351
h. 6

Art. 0352
h. 8

Art. 0353
h. 10



Art. 0917
Ø 17



Art. 0918
Ø 17



Fedi nuziali
Art. 0924
3 x 4,6

Art. 0924SAT
3 x 4,6



■ mm 2,5

■ **Art. 0305**
h. 10 x 5,5

Art. 0306
h. 15 x 8

Art. 0305SAT
h. 10 x 5,5



■ **Art. 0618** ■■
h. 16 x 8

Art. 0619 ■■
h. 23 x 12

Croce
acciaio inox microfuso



□ mm 10 x 10

■ **Art. 0323**
h. 15 x 7

Art. 0324
h. 20 x 9

Art. 0325
h. 25 x 9

Art. 0326
h. 30 x 9



■ **Art. 0337**
h. 8,5 x 6

Art. 0340
h. 21,5 x 14

Art. 0338
h. 10,5 x 7,5

Art. 0341
h. 26 x 18

Art. 0339
h. 14 x 10,5

Art. 0342
h. 41 x 30



■ **Art. 0274**
h. 6

Art. 0275
h. 8

Art. 0276
h. 10



□ mm 7 x 10

■ **Art. 0221**
h. 15 x 5,5

Art. 0222
h. 20 x 5,5

Art. 0223
h. 25 x 7,5

Art. 0224
h. 30 x 7,5

□ mm 10 x 20

Art. 0229
h. 30 x 10

Art. 0230
h. 40 x 10



■ **Art. 0315**
h. 13 x 7,5

Art. 0316
h. 16 x 9,5

Art. 0317
h. 24 x 13,5

Art. 0318
h. 33 x 18



Art. 0530 ●● mm 6
h. 16 x 8



Art. 0386 ●● mm 8
h. 24 x 12



Art. 0529 ●● mm 6
h. 16 x 8

Art. 0536 ●● mm 6
h. 24 x 12

Art. 053630 ●● mm 10
h. 30 x 15

Art. 0213 ●● mm 12
h. 40 x 22

Art. 0214 ●● mm 12
h. 50 x 22



Art. 0531 ●● mm 6
h. 16 x 8



Art. 0386U ●● mm 8
h. 24 x 12



■ mm 10 x 10

Art. 024520
h. 20 x 10

Art. 024530
h. 30 x 13

Art. 0245
h. 40 x 20

Art. 0246
h. 50 x 20



●● mm 10 ●● mm 12
Art. 021830 Art. 021840
h. 30 x 15 h. 40 x 18

Art. 0218
h. 50 x 20,8



■ mm 8 ■ mm 10
Art. 0281 Art. 027130
h. 24 x 12,5 h. 30 x 15

Art. 0271
h. 40 x 21,5

Art. 0272
h. 50 x 21,5



■ mm 8 ■ mm 10
Art. 021930 Art. 021940
h. 30 x 15 h. 40 x 16

Art. 0219
h. 50 x 20



Esempio croce h.80
con applicazione tipo H
Art. 066108H

Example of a cross 80 cm high with
decoration type H

● mm 18

Art. 066106...
h. 60 x 30

Art. 066110...
h. 100 x 40

Art. 066108...
h. 80 x 35

Art. 066112...
h. 120 x 45



Esempio croce h.80
con applicazione tipo E
Art. 066208E

Example of a cross 80 cm high with
decoration type E

■ mm 16

Art. 066206...
h. 60 x 30

Art. 066210...
h. 100 x 40

Art. 066208...
h. 80 x 35

Art. 066212...
h. 120 x 45

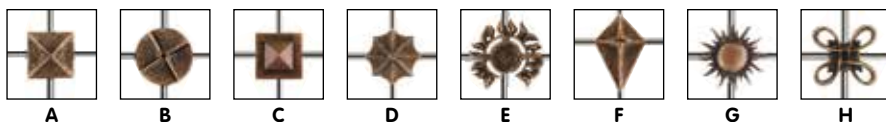

Tipi di applicazione: aggiungere la lettera corrispondente al codice prodotto.
Types of decoration

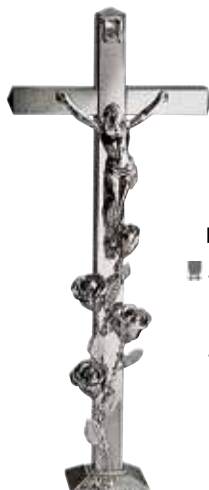

□ mm 35

Art. 0216
h. 60 x 25

Art. 0217
h. 80 x 27



●● mm 12

Art. 0211
h. 60 x 22

Art. 0204
h. 80 x 22

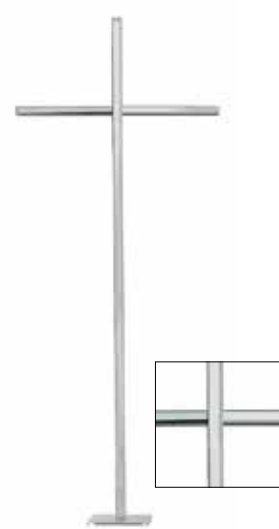
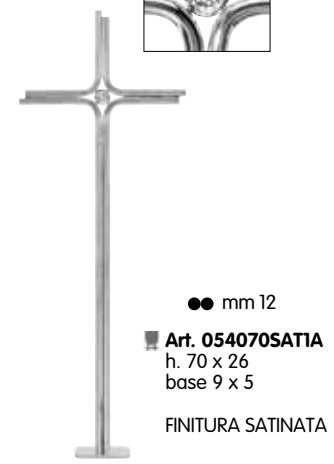
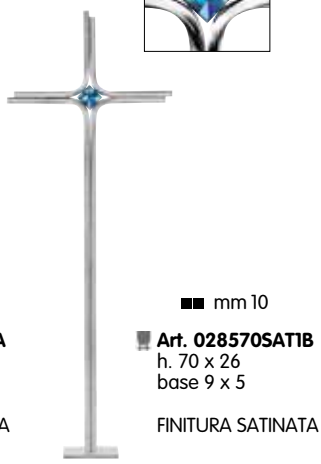
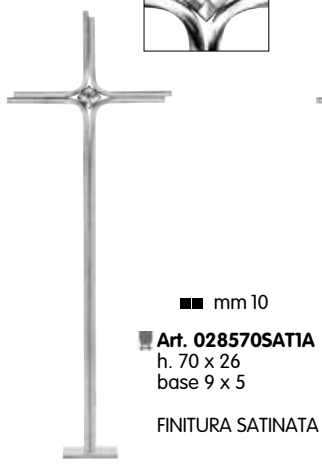
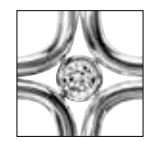
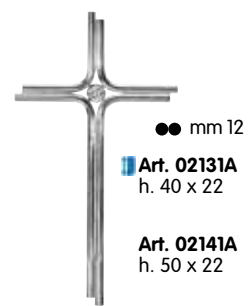
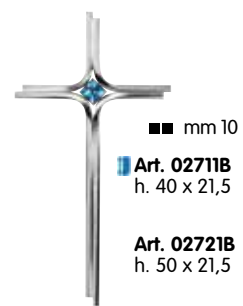
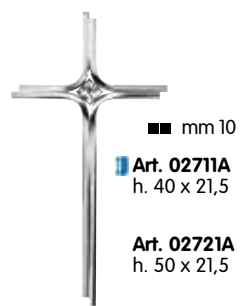



Art. 8129
h. 19 x 23 x 17
ℓ. 4 - cu. in. 244

a richiesta
 Art. 8150



Art. 8131
h. 19 x 23 x 17
ℓ. 4 - cu. in. 244

a richiesta
 Art. 8150



Art. 8127
h. 25 x Ø 20
ℓ. 4,5 - cu. in. 275



-Art. 8132
h. 23 x 18 x 18
ℓ. 4 - cu. in. 244

a richiesta
 Art. 8150



Art. 8130
h. 19 x 23 x 17
ℓ. 4 - cu. in. 244

a richiesta
 Art. 8150



Art. 8136
h. 20 x 22 x 17
ℓ. 4 - cu. in. 244

a richiesta
 Art. 8150



Art. 8139
h. 15 x 24 x 20 - ℓ . 4,7 - cu. in. 287



Art. 8138
h. 15 x 24 x 20 - ℓ . 4,7 - cu. in. 287



Art. 8137
h. 15 x 24 x 20 - ℓ . 4,7 - cu. in. 287



Art. 8140
h. 15 x 24 x 20 - ℓ . 4,7 - cu. in. 287



Art. 8147
h. 16 x 24 - ℓ . 2,5 cu. in. 153

a richiesta
 Art. 8112



Art. 8146
h. 16 x 24 - ℓ . 2,5 - cu. in. 153

a richiesta
 Art. 8112



Art. 8027
h. 16 x 24 - ℓ . 2,5 cu. in. 153

a richiesta
 Art. 8112



Art. 8038
h. 16 x 24 - ℓ . 2,5 cu. in. 153

a richiesta
 Art. 8112



Art. 8145
h. 16 x 24 - ℓ . 2,5 cu. in. 153

a richiesta
 Art. 8112



Art. 8122
h. 27 x 14
€ 2,1 - cu. in. 128



Art. 8097
h. 30 x 18
€ 4 - cu. in. 244



Art. 8125
h. 20 x 19
€ 1,9 - cu. in. 116



Art. 8126U
h. 15 x Ø 23
€ 3,5 - cu. in. 213

Art. 8119
h. 31 x 15
€ 4 - cu. in. 244



Art. 8169
h. 9 x 5 x 5
€ 0,075
cu. in. 4.5



Art. 8170
h. 7 x 3 x 3,5
€ 0,030
cu. in. 1.8



Art. 8109
h. 7,5 x 4
€ 0,004
cu. in. 0.2



Art. 8108
h. 7 x 3
€ 0,007
cu. in. 0.4



Art. 8148
h. 10 x 8,5
€ 0,25
cu. in. 15



Art. 8115
h. 15 x Ø 7
€ 0,33
cu. in. 20

Art. 8098
h. 9 x 4
€ 0,075
cu. in. 4.5

Art. 8099
h. 7 x 3
€ 0,030
cu. in. 1.8



Art. 8133U
h. 25 x 18 x 11
€ 3,5 - cu. in. 213



Art. 8133
h. 25 x 18 x 11
€ 3,5 - cu. in. 213



Esempio
con applicazione
adesiva



Art. 8134
h. 25 x 18 x 11
€ 3,5 - cu. in. 213



Esempio con targhetta e
cornice adesiva



Art. 816330
h. 31 x 18
ℓ. 4,1 - cu. in. 250



Art. 816320
h. 21 x 12
ℓ. 1,3 - cu. in. 79



Art. 816413
h. 10 x 10 x 8,5
ℓ. 0,42 - cu. in. 26



Art. 816408
h. 7 x 6
ℓ. 0,1 - cu. in. 6



Art. 816518
h. 19 x 18 x 13
ℓ. 2 - cu. in. 122



Art. 8040
h. 18,5 x 30,5
ℓ. 6,5 - cu. in. 396



Art. 8050
h. 28,5 x 22 x 8,5
ℓ. 3,5 - cu. in. 244

a richiesta
 Art. 8149

CORNICI ADESIVE · ADHESIVE FRAMES

APPLICAZIONI ADESIVE ■ ■ · ADHESIVE ORNAMENTS



Art. 1449/H
per foto 7 x 9



Art. 4276
per foto 2,5 x 3,5

Art. 27E7
h. 3,1 x 8,3



Art. 4200/A
Ø 7



Art. 4200/B
Ø 7



Art. 4200/C
Ø 7



Art. 817208
h. 46,5 x 26 x 3,5
ℓ. 3 - cu. in. 183



Art. 8172B
h. 46,5 x 26 x 3,5
ℓ. 3 - cu. in. 183

Smaltata Botticino



Art. 81725SAT
h. 48 x 31 x 4,8
ℓ. 5 - cu. in. 305

Acciaio Satinato

Esempio



Art. 8173
h. 9,5 x 23,5 x 18,5
ℓ. 3,2 - cu. in. 195



Art. 8174W
h. 10 x 46 x 20,5 ℓ. 8
cu. in. 488

urna realizzata in lamiera di acciaio



Esempio con
Art. Kosmolux K0202

Urna doppia adattabile anche come base per max. 20 kg.

Double Urn, also suitable for use as a base, up to max. 20 kg (44 lbs) weight capacity.



Art. 8060
h. 24 x 14,5
€ 4
cu. in. 244

a richiesta
 Art. 8111

Art. 8059
h. 19,5 x 16
€ 4
cu. in. 244

a richiesta
 Art. 8101

Art. 8058
h. 19 x 13
€ 2,5
cu. in. 152

a richiesta
 Art. 8100



Art. 8095
h. 24 x 14,5
€ 4
cu. in. 244

a richiesta
 Art. 8111

Art. 8094
h. 19,5 x 16
€ 4
cu. in. 244

a richiesta
 Art. 8101

Art. 8093
h. 19 x 13
€ 2,5
cu. in. 152

a richiesta
 Art. 8100



***Art. 8060R**
h. 24 x 14,5
€ 4
cu. in. 244

a richiesta
 Art. 8111

***Art. 8059R**
h. 19,5 x 16
€ 4
cu. in. 244

a richiesta
 Art. 8101

***Art. 8058R**
h. 19 x 13
€ 2,5
cu. in. 152

a richiesta
 Art. 8100



***Art. 8095R**
h. 24 x 14,5
€ 4
cu. in. 244

a richiesta
 Art. 8111

***Art. 8094R**
h. 19,5 x 16
€ 4
cu. in. 244

a richiesta
 Art. 8101

***Art. 8093R**
h. 19 x 13
€ 2,5
cu. in. 152

a richiesta
 Art. 8100



***Verde Alpi**
Art. 8152K
h. 18 x 21,5 x 10,5
€ 3 - cu. in. 183

***Radica**
Art. 8152R
h. 18 x 21,5 x 10,5
€ 3 - cu. in. 183

Bianco
Art. 8152V
h. 18 x 21,5 x 10,5
€ 3 - cu. in. 183

***Bianco Carrara**
Art. 8152L
h. 18 x 21,5 x 10,5
€ 3 - cu. in. 183

***New botticino**
Art. 8152J
h. 18 x 21,5 x 10,5
€ 3 - cu. in. 183



■ **Art. 8176W**
h. 29 x Ø 19,5
ℓ. 5 - cu. in. 305



■ **Art. 8176BE**
h. 29 x Ø 19,5
ℓ. 5 - cu. in. 305



■ **Art. 8187**
h. 29,2 x Ø 18,3
ℓ. 5 - cu. in. 305



■ **Art. 8175TB**
h. 27,6 x Ø 18,2
ℓ. 5 - cu. in. 305



Rame - Copper
■ **Art. 8178**
h. 27,4 x Ø 18,2
ℓ. 5 - cu. in. 305



■ **Art. 8183**
h. 25,8 x Ø 18,3
ℓ. 4 - cu. in. 244



■ **Art. 8175RED**
h. 27,6 x Ø 18,2
ℓ. 5 - cu. in. 305



Rame - Copper
■ **Art. 8177**
h. 28,2 x Ø 18,9
ℓ. 5 - cu. in. 305



■ **Art. 8182**
h. 27,8 x Ø 21,5
ℓ. 5 - cu. in. 305



 **Art. 8175GR**
h. 27,6 x Ø 18,2
ℓ. 5 - cu. in. 305



 **Art. 8181**
h. 26,5 x Ø 19,4
ℓ. 4,5 - cu. in. 275



 **Art. 8186**
h. 26,2 x Ø 18,3
ℓ. 4 - cu. in. 244



 **Art. 8175BLU**
h. 27,6 x Ø 18,2
ℓ. 5 - cu. in. 305



Rame - Copper
 **Art. 8180**
h. 25,4 x Ø 18,2
ℓ. 4 - cu. in. 244



 **Art. 8185**
h. 28,8 x Ø 19,2
ℓ. 5 - cu. in. 305



 **Art. 8188**
h. 27,6 x Ø 18,2
ℓ. 5 - cu. in. 305



 **Art. 8175W**
h. 27,6 x Ø 18,2
ℓ. 5 - cu. in. 305



Rame - Copper
 **Art. 8179**
h. 25,4 x Ø 18,2
ℓ. 4 - cu. in. 244



 **Art. 8184**
h. 26,6 x Ø 18,3
ℓ. 4 - cu. in. 244



■ ■ Urne cinerarie
in bronzo



***Verde Alpi**

Art. 8133K
h. 25 x 19 x 11
€ 3,5 - cu. in. 213



***Radica**

Art. 8133R
h. 25 x 19 x 11
€ 3,5 - cu. in. 213



Bianco

Art. 8133V
h. 25 x 19 x 11
€ 3,5 - cu. in. 213



***Bianco Carrara**

Art. 8133L
h. 25 x 19 x 11
€ 3,5 - cu. in. 213



***New botticino**

Art. 8133J
h. 25 x 19 x 11
€ 3,5 - cu. in. 213

■ ■ Urne cinerarie
in alluminio



***Bianco Carrara**

Art. 8151L
h. 23,5 x Ø 18
€ 3,5 - cu. in. 213



***New botticino**

Art. 8151J
h. 23,5 x Ø 18
€ 3,5 - cu. in. 213



***Verde Alpi**

Art. 8151K
h. 23,5 x Ø 18
€ 3,5 - cu. in. 213



***Radica**

Art. 8151R
h. 23,5 x Ø 18
€ 3,5 - cu. in. 213



Bianco

Art. 8151V
h. 23,5 x Ø 18
€ 3,5 - cu. in. 213





Rame Anticato

Art. 8161P01

h. 28 x 17 - \varnothing . 4 - cu. in. 244



Rame Pompeiano

Art. 8161P

h. 28 x 17 - \varnothing . 4 - cu. in. 244



Rame

Art. 8161

h. 28 x 17 - \varnothing . 4 - cu. in. 244

*Chiusura ermetica
a vite urne in rame*



Bronzo

Art. 8162P03

h. 28 x 17 - \varnothing . 4 - cu. in. 244



Bianco

Art. 8162V

h. 28 x 17 - \varnothing . 4 - cu. in. 244



Pompeiano

Art. 8162P

h. 28 x 17 - \varnothing . 4 - cu. in. 244

*Chiusura a pressione
urne in alluminio*



***Verde Alpi**

Art. 8162K

h. 28 x 17
 \varnothing . 4 - cu. in. 244



***Radica**

Art. 8162R

h. 28 x 17
 \varnothing . 4 - cu. in. 244



***Bianco Carrara**

Art. 8162L

h. 28 x 17
 \varnothing . 4 - cu. in. 244



***New Botticino**

Art. 8162J

h. 28 x 17
 \varnothing . 4 - cu. in. 244

*Chiusura a pressione
urne in alluminio*

■ ■ Urne cinerarie
Rame e Alluminio



■ ■ **Art. 8046**
h. 26,5 x Ø 18
€ 4,5 - cu. in. 275

■ ■ **Art. 8046A**
h. 26,5 x Ø 18
€ 4,5 - cu. in. 275
Alluminio



■ ■ **Art. 8088**
h. 26 x Ø 18
€ 4,5 - cu. in. 275

■ ■ **Art. 8088A**
h. 26 x Ø 18
€ 4,5 - cu. in. 275
Alluminio

■ ■ Urne cinerarie
in alluminio



***Verde Alpi**
Art. 8159K
h. 26,5 x Ø 18
€ 5,5 - cu. in. 335

a richiesta
■ ■ Art. 8144



***Radica**
Art. 8159R
h. 26,5 x Ø 18
€ 5,5 cu. in. 335

a richiesta
■ ■ Art. 8144



***Bianco Carrara**
Art. 8159L
h. 26,5 x Ø 18
€ 5,5 cu. in. 335

a richiesta
■ ■ Art. 8144



Marrone
Art. 8159
h. 26,5 x Ø 18
€ 5,5 - cu. in. 335

a richiesta
■ ■ Art. 8144



Bianco
Art. 8159V
h. 26,5 x Ø 18
€ 5,5 - cu. in. 335

a richiesta
■ ■ Art. 8144



***New botticino**
Art. 8159J
h. 26,5 x Ø 18
€ 5,5 cu. in. 335

a richiesta
■ ■ Art. 8144



Marrone

•Art. 8158
h. 19 x 25,5 x 16
ℓ. 4,5 - cu. in. 274



***Verde Alpi**

•Art. 8158K
h. 19 x 25,5 x 16
ℓ. 4,5 - cu. in. 274



Bianco

•Art. 8158V
h. 19 x 25,5 x 16
ℓ. 4,5 - cu. in. 274



Contenitore zincato per cinerari 8159

Art. 8144
h. 21 x Ø 18
ℓ. 5 - cu. in. 305



Art. 8101
ℓ. 3 - cu. in. 183
per urne 8059 - 8094

Art. 8100
ℓ. 2 - cu. in. 125
per urne 8058 - 8093

Art. 8111
ℓ. 2,8 - cu. in. 170
per urne 8060 - 8095



Art. 8112
ℓ. 2 - cu. in. 125
per urne 8027 - 8038
8145 - 8146 - 8147



Art. 8150
ℓ. 3,5 - cu. in. 213
per urne 8129 - 8130
8131 - 8132 - 8136



Art. 8149
ℓ. 2 - cu. in. 125
per urne 8040

I coperchi dei contenitori sono predisposti per la saldatura a stagno.



ZINCATO
Art. 2219E
h. 24 x 56 x 25



ZINCATO
Art. 2217
h. 25 x 51 x 22

Art. 2219
h. 25 x 56 x 24

Art. 2223
h. 28 x 62 x 28



Pstau antiurto
Art. 2214
h. 24 x 57 x 26

Chiusura ad incastro

Il coperchio è dotato di appositi bordi che consentono un'ottima chiusura con 2 viti autofilettate.

Chiusura ermetica

Con la distribuzione del silicone sui bordi del coperchio, si ottiene una saldatura ermetica.

Determinate caratteristiche tecniche costruttive studiate appositamente, contraddistinguono il cofanetto BIONDAN in Pstau.



Art. 8806
Ø 20 - ℓ 3 - cu. in. 183



Art. 8805
Ø 21 x 21,5 - ℓ 3 - cu. in. 183



Art. 8801
Ø 20 - ℓ 3 - cu. in. 183



Art. 8802
h. 18,4 x 19,2 - ℓ 3 - cu. in. 183



Art. 8802/L
h. 18,4 x 21 - ℓ 3 - cu. in. 183



Art. 8802/R
h. 18,4 x 21 - ℓ 3 - cu. in. 183



Art. 8803
h. 19 x 18,8 - ℓ 3 - cu. in. 183



Art. 8804
h. 21 x 21,5 - ℓ 3 - cu. in. 183

BIONDAN firma la nuova collezione di urne in Argento 925 Sterling

Una selezione di disegni esclusivi che prendono forma attraverso un metodo di lavorazione di altissimo livello qualitativo. Vengono utilizzate tecniche di lavorazione molto antiche come la fusione in terra di Francia, lo sbalzo, la cesellatura, arrivando alla realizzazione, interamente a mano, di prodotti di grande fascino.

BIONDAN has signed a new collection of urns in Silver 925 Sterling

A selection of exclusive designs produced by means of a top quality processing method. It lends itself to countless different kinds of processing, together with copper, according to percentages set down by the law. Ancient processing techniques are used - sand casting, embossing and engraving - to produce beautiful, entirely hand-crafted items.



Art. 0063
h. 21 x 17 x 17
z. 5 - cu. in. 305



Art. 0062
h. 21 x 21,5 x 10
z. 4 - cu. in. 245

VERSIONI CON APPLICAZIONI



Art. 0063A



Art. 0063B



Art. 0062C



Art. 0062B



Art. 0063D



Art. 0063E



Art. 0062F



Art. 0062G



Art. 0063H



Art. 0062H



Big Box

**Box in velluto
Velvet Box**

Art. 899902 ■■
h. 29,5 x 21,5 x 21,5
Dimensioni interne
h. 29 x 20,5 x 20,5



Medium Box

**Box in velluto
Velvet Box**

Art. 899903 ■■
h. 21,5 x 27 x 21,5
Dimensioni interne
h. 21 x 26 x 20,5



Small Box

**Box in velluto
Velvet Box**

Art. 899904 ■■
h. 22 x 18,5 x 18,5
Dimensioni interne
h. 21,5 x 17,5 x 17,5



**Cofanetto legno porta-urne
Wooden box for urns**

Art. 899901 ■■
h. 26,5 x 30 x 22
Dimensioni interne
h. 21 x 28 x 20



**Cofanetto legno porta-urne
Wooden box for urns**

Art. 8999 ■■
h. 34,5 x 23,5
Dimensioni interne
h. 29 x 21,5



**Esempio con
urna Art. 8162P03**



**Esempio con
applicazione
Art. 2743**

CONFEZIONI PORTA-URNE · BOXES FOR URNS

Box in velluto

Velvet Boxes

Cofanetti in legno

Wooden boxes for urns



Codice Articolo	899902	899903	899904	8999	899901
0062	-	•	-	-	•
0063	•	-	-	•	-
8027	-	•	-	-	•
8038	-	•	-	-	•
8046 8046A	•	-	-	•	-
8050	-	-	-	•	-
8058 8058R	-	-	•	-	-
8059 8059R	•	-	•	-	-
8060 8060R	•	-	-	•	-
8088 8088A	•	-	-	•	-
8093 8093R	-	-	•	-	-
8094 8094R	•	-	•	-	-
8095 8095R	•	-	-	•	-
8097	-	-	-	•	-
8122	•	-	-	•	-
8125	-	-	•	-	-
8127	•	-	-	•	-
8129	-	•	-	-	•
8130	-	•	-	-	•
8131	-	•	-	-	•
8132	•	-	-	•	-
8133 (J-K-L-R-U-V)	•	-	-	•	-
8134	•	-	-	•	-
8136	-	•	-	-	•
8137	-	•	-	-	•
8138	-	•	-	-	•
8139	-	•	-	-	•
8140	-	•	-	-	•
8145	-	•	-	-	•
8146	-	•	-	-	•
8147	-	•	-	-	•
8151 (J-K-L-R-V)	•	-	-	•	-
8152(J-K-L-R-V)	-	•	-	-	•
8159(J-K-L-R-V)	•	-	-	•	-
8161 8161P	•	-	-	•	-
8161P01	•	-	-	•	-
8162(J-K-L-P-R-V)	•	-	-	•	-
8162P03	•	-	-	•	-
816320	-	-	•	-	-
816518	-	-	•	-	-
8173	-	•	-	-	•
K2823 (AG-BL-P)	-	•	-	-	•
8175BLU	•	-	-	•	-
8175GR	•	-	-	•	-
8175TB	•	-	-	•	-
8175W	•	-	-	•	-
8175RED	•	-	-	•	-
8176BE	•	-	-	•	-
8176W	•	-	-	•	-
8177	•	-	-	•	-
8178	•	-	-	•	-
8179	•	-	-	•	-
8180	•	-	-	•	-
8181	•	-	-	•	-
8182	•	-	-	•	-
8183	•	-	-	•	-
8184	•	-	-	•	-
8185	•	-	-	•	-
8186	•	-	-	•	-
8187	•	-	-	•	-
8188	•	-	-	•	-
8801	-	-	-	•	-
8802 (L-R)	•	-	-	•	-
8803	•	-	-	•	-
8804	-	-	-	•	-
8806	-	-	-	•	-

Art. F/1008
Ø 5 cm



Art. F/1009
Ø 5 cm



Art. F/998D
iridescente
Ø 5 cm



Art. F/998G
Art. F/998B
Ø 5 cm



Art. F/99804
Ø 4 cm

Art. F/998
Ø 5 cm



Art. F/1003D
iridescente
Ø 5 cm



Art. F/100304
Ø 4 cm

Art. F/1003G
Art. F/1003B
Ø 5 cm

Art. F/1003
Ø 5 cm

Colori disponibili:



B



G



D

3 lati

3 lati

MICRO PER OSSARI



Art. F/993
Ø 4 cm



Art. F/993B
Ø 4 cm



Art. F/993G
Ø 4 cm



Art. F/993D
Ø 4 cm



Art. F/28
Ø 5 media



Art. F/31
Ø 5 media

RICAMBI ■ ■



Art. F/01L
Micro Ø 4
fiamma per
LM1F - LM8F - LM9F



Art. F/02L
Media Ø 5
fiamma per LM2F



Art. F/03L
Mignon Ø 6
fiamma con adattatore
per LM6 - 4970/E

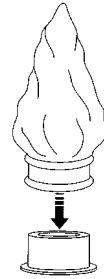

Esempio F/03L



Art. F/12
Ø 5 media



Art. F/01
Ø 4 micro



Art. F/03
Ø 6 mignon



Art. F/10



Art. F/08
Ø 2 micro

Art. F/02
Ø 5 media

Art. F/04
Ø 8 grande

Art. F/02G
Ø 5 media

LUCE INTERMITTENTE · FLICKERING LIGHT

DURATA DI FUNZIONAMENTO 6 MESI

**LM1** (rosso)
LM1M (marrone)
h. 13 x 6
(n° 2 pile/batteries
1/2 torcia 1,5V C)**LM1FM** (marrone)
LM1F (rosso)
h. 16 x 6 - F/01L
(n° 2 pile/batteries
1/2 torcia 1,5V C)**LM2** (rosso)
LM2M (marrone)
h. 10 x 7,5
(n° 4 pile/batteries
stilo 1,5V AA)**LM2F** (rosso)
LM2FM (marrone)
h. 16 x 7,5 - F/02L
(n° 4 pile/batteries
stilo 1,5V AA)**LM9** (rosso)
LM9M (marrone)
h. 9,5 x 6
(n° 4 pile/batteries
stilo 1,5V AAA)**LM9FM** (marrone)
LM9F (rosso)
h. 13 x 6 - F/01L
(n° 4 pile/batteries
stilo 1,5V AAA)

DURATA DI FUNZIONAMENTO 6 MESI

**LM8** (rosso)
LM8M (marrone)
h. 13 x 7,5
(n° 4 pile/batteries
1/2 torcia 1,5V C)**LM8FM** (marrone)
LM8F (rosso)
h. 16 x 7,5 - F/01L
(n° 4 pile/batteries
1/2 torcia 1,5V C)**LUCE MODULATA** · REAL FLAME EFFECT

DURATA DI FUNZIONAMENTO 16 MESI

**LM1BH**
h. 13 x 6
(n° 2 pile 1/2 torcia 1,5V C)**LM2BH**
h. 10 x 7,5
(n° 4 pile stilo 1,5V AA)**LM9BH**
h. 9,5 x 6
(n° 4 pile stilo 1,5V AAA)

LUCE INTERMITTENTE · FLICKERING LIGHT

DURATA DI FUNZIONAMENTO 6 MESI

**LM6**

Inseribili nelle fiamme
F/02 - F/03L - F/12
h. 12 x 4,2
(n° 4 pile/batteries
stilo 1,5V AA)

LUCE MODULATA · REAL FLAME EFFECT

DURATA DI FUNZIONAMENTO 6 MESI

**LM6BH**

Inseribili nelle fiamme
F/02 - F/03L - F/12
h. 12 x 4,2
(n° 4 pile/batteries 1,5V AA)

LUCE INTERMITTENTE · FLICKERING LIGHT

DURATA DI FUNZIONAMENTO 4 MESI

**LM7**

Inseribili nelle fiamme
F/01 - F/02 - F/12
h. 9,5 x 3,5
(n° 2 pile/batteries
stilo 1,5V AA)

LUCE MODULATA · REAL FLAME EFFECT

DURATA DI FUNZIONAMENTO 4 MESI

**LM7BH**

Inseribili nelle fiamme
F/01 - F/02 - F/12
h. 9,5 x 3,5
(n° 2 pile/batteries
stilo 1,5V AA)

**LM10**

Inseribili nelle fiamme. F/02 - F/12 - F/03L
h. 6 x 4 (n° 2 pile/batteries stilo 1,5V AA)

**LM10BH**

Inseribili nelle fiamme. F/02 - F/12 - F/03L
h. 6 x 4 (n° 2 pile/batteries stilo 1,5V AA)

RICAMBI ACCUMULATORI RICARICABILI PER LAMPADE SOLARI

Art. 4903/E
h. 3,5 x Ø 7
2 Accumulatori



Art. 4973/EA
h. 5,5 x Ø 4
3 Accumulatori



Art. 4973/EC
h. 5,5 x Ø 4
2 Accumulatori



Art. 4973/EB
h. 3,5 x Ø 7
3 Accumulatori



Art. 4932/E
7,5 x 7,5

N. 2 Accumulatori per pannello 7,5 x 7,5 Art. 4932/E - N. 3 Accumulatori per pannello 12,5 x 12,5

LUCE INTERMITTENTE · FLICKERING LIGHT

Art. 4972/EB
per lamp. cero

Art. 4972/EBM
colore marrone



Art. 4972
per lamp.
elettrica
2/3 accumulatori

Impianto Elettronico Solare completo di pannello segnalatore e accumulatore



Art. 4974/EB
per lamp. cero

Art. 4903/E
Ricambio accumulatore



Art. 4974/EA
per lamp. elettrica

Art. 4973/EC
Ricambio accumulatore

ILLUMINAZIONE A LED **BREVETTATA** PER SOSTITUZIONE LAMPADINE TRADIZIONALI
PATENTED LED LIGHT FOR REPLACEMENT OF TRADITIONAL BULBS

■ ■ LED HARMONY A LUCE MODULATA - "REAL FLAME" EFFECT



Art. 4941
 Led ottagonale
 (3 Led gialli + 1 Led blu)
 completo di cavo 95 cm
 e sostegni per F/01 e F/02
 Con il sistema Clic-Clac
 il Led può essere
 rimosso e sostituito

Art. 4941CD
 Impianto completo:
 Cavo 120 cm - Supporto
 per Led ad innesto - LED
 4941C - Sostegno per
 F/01 e F/02



Art. 4941CMA
 Impianto completo:
 Cavo 110 cm - Supporto
 per Led avvitabile - LED
 4941CM Sostegno per
 F/01 e F/02



Art. 4941C
 LED ad innesto (3 Led
 bianchi + 1 Led rosso)



Art. 4941CM
 LED avvitabile (3 Led
 bianchi + 1 Led rosso)



■ ■ LED A LUCE FISSA - CONSTANT LED LIGHT



Art. 494002
 Impianto completo:
 Cavo 120 cm - Supporto
 per Led ad innesto - LED
 494001 Sostegno per
 F/01 e F/02



Art. 494002M
 Impianto completo:
 Cavo 110 cm - Supporto
 per Led avvitabile - LED
 494001M - Sostegno per
 F/01 e F/02



Art. 494001
 LED ad innesto
 (3 Led bianchi)



Art. 494001M
 LED avvitabile
 (3 Led bianchi)



COMPLETE WIRING

LED

AETERNUM

LUCE MODULATA - REAL FLAME EFFECT



Art. 5100 ■ ■
 h. 15 x 8

Art. 510002 ■ ■
 h. 10,5 x 6,5

Art. 510003 ■ ■
 h. 8 x 3,5
 Applicabile alle fiamme
 F/01 - F/02 - F/12

(Accumulatori in omaggio)

CERI - WAX CANDLES ■

Esempio
 cero bianco



Art. 4991 Rosso - red
Art. 4991B Bianco - white
 h. 9,5 x Ø 6,5

Art. 4994 Rosso - red
Art. 4994B Bianco - white
 h. 18 x Ø 6,5



Art. 4990
 Rosso - red
 h. 3 x Ø 5

Ceri a batteria

LUXOR
BRONZE POLISH



Lucidante conservante universale per bronzi, marmi e graniti

Art. 4996 ◆
ml 250
(12 pezzi)

Art. 4984 ◆
ml 250
(1 pezzo)

Non contiene propellenti inquinanti

MASTICI ◆
GLUE



Art. 4944
mastice paglierino fluido
ml. 750

Art. 4944T
mastice incolore fluido
ml. 750

Art. 4945
mastice paglierino
Tixo verticale
ml. 750

Art. 4945T
mastice incolore
Tixo verticale
ml. 750

Art. 4945N
mastice nero
ml. 750

Regolo



Art. 0998/4 ■
Kit asta metrica per lettere adesive con livella a laser



Art. 0998/3 ■
Kit asta metrica per lettere adesive con livella classica

Verificare la pulizia delle ventose e nel caso, prima dell'utilizzo, passare un panno umido per garantire la massima resa.



Art. 5000A
misure in cm:
h. 176 x P33 x L67



Art. 5001A
misure in cm:
h. 176 x P33 x L37



Art. 5002A
misure in cm:
h. 176 x P63 x L56

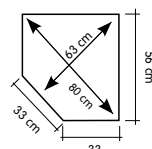

Art. 4920B
h. 248 x 75
a 3 pannelli
h. 65 x 75



Art. 4920A
h. 248 x 75
a 3 pannelli
h. 65 x 75



Art. 4920C
h. 288 x 75 x 50

Le nuove vetrine per esporre i prodotti sono la risposta alle esigenze dei nostri clienti che desiderano far vedere e toccare con mano la qualità BIONDAN; vetrine eleganti, adattabili ad ogni ambiente sia moderno che classico; vetrine indispensabili. I modelli delle vetrine possono subire leggere variazioni costruttive e non costituiscono elemento di contestazione per il costruttore.

CASELLARI ■



Pstau antiurto/
Anticrash

Art. 4913
h. 11 x 72 x 42
32 spazi

Art. 4914
h. 11 x 72 x 42
24 spazi

CASSETTIERE ■



Art. 4910
h. 106 x 74 x 59
n° 3 cassetti a 20 scomparti
n° 3 cassetti a 30 scomparti



Art. 4916
h. 55 x 60 x 50
n° 4 cassetti
a 30 scomparti



Art. 4911
h. 95 x 60 x 50
n° 8 cassetti
a 30 scomparti

CONTENITORI IN PLASTICA

Art. 4927
base 12,3 x 12,3 x h. 13,5
n° 35 per cassetto
grande

Art. 4928
base 10 x 10 x h. 12
n° 48 per cassetto
medio

Art. 4929
base 7,7 x 7,7 x h. 8
n° 88 per cassetto
piccolo



Art. 4926
h. 106 x 99 x 66



Art. 4909
vetrina da applicare sul retro della
cassettiera art. 4926 ad uso esposizione
h. 100 x 99 x 25

FORMATO OVALE



BIANCO & NERO

COLORE

Art. 4943	5 x 7		Art. 4943C	5 x 7	
Art. 4946	6 x 8	Art. 49462	Art. 4946C	6 x 8	Art. 4946C2
Art. 4947	7 x 9	Art. 49472	Art. 4947C	7 x 9	Art. 4947C2
Art. 4948	8 x 10	Art. 49482	Art. 4948C	8 x 10	Art. 4948C2
Art. 4949	9 x 12	Art. 49492	Art. 4949C	9 x 12	Art. 4949C2
Art. 4950	11 x 15	Art. 49502	Art. 4950C	11 x 15	Art. 4950C2
Art. 4951	13 x 18	Art. 49512	Art. 4951C	13 x 18	Art. 4951C2
Art. 4952	18 x 24	Art. 49522	Art. 4952C	18 x 24	Art. 4952C2

FORMATO RETTANGOLARE



BIANCO & NERO

COLORE

Art. 4954	8 x 10	Art. 49542	Art. 4954C	8 x 10	Art. 4954C2
Art. 4955	9 x 12	Art. 49552	Art. 4955C	9 x 12	Art. 4955C2
Art. 4956	10 x 15	Art. 49562	Art. 4956C	10 x 15	Art. 4956C2
Art. 4958	13 x 18	Art. 49582	Art. 4958C	13 x 18	Art. 4958C2
Art. 4959	18 x 24	Art. 49592	Art. 4959C	18 x 24	Art. 4959C2

FORMATO ROTONDO



BIANCO & NERO

COLORE

Art. 4942	Ø 5	Art. 4942C	Ø 5
Art. 4960	Ø 7	Art. 4960C	Ø 7
Art. 4961	Ø 8	Art. 4961C	Ø 8
Art. 4962	Ø 10	Art. 4962C	Ø 10
Art. 4963	Ø 12	Art. 4963C	Ø 12
Art. 4964	Ø 15	Art. 4964C	Ø 15

FORMATO CUORE



BIANCO & NERO

COLORE

Art. 49368	8 x 8	Art. 49368C	8 x 8
Art. 493610	10 x 10	Art. 493610C	10 x 10
Art. 493612	12 x 12	Art. 493612C	12 x 12
Art. 493615	15 x 15	Art. 493615C	15 x 15



Art. 4276
per foto 2,5 x 3,5
(cameo - adesiva)

FOTOSMALTO

Art. 4965 - "CAMEO" foto in bianco/nero.
Art. 4965C - "CAMEO" foto a colori.

Varie misure e formati disponibili:

Art. 4953 - **Provino fotografico** 13 x 18 cm con ritocco da eseguirsi su carta fotografica per gli originali non perfetti
Firma o diciture semplici aumento del 10%. Nel prezzo delle nostre fotoricettine è compreso il filo oro.
Art. 4937 - **Fotoritocco** da apportare alle foto originali



Universale a percussione e rotazione per graniti e marmi
 Universal rotation and percussion bit for granite and marble

- | | |
|--------------------------|-------------------------|
| Art. 0955/S Ø 2,5 | Art. 0960/S Ø 6 |
| Art. 0956/S Ø 3 | Art. 0961/S Ø 7 |
| Art. 0957/S Ø 3,5 | Art. 0962/S Ø 8 |
| Art. 0958/S Ø 4 | Art. 0963/S Ø 10 |
| Art. 0959/S Ø 5 | Art. 0964/S Ø 12 |



A percussione per granito e marmo
 Yellow, for granite and marble

- | | |
|--------------------------|-------------------------|
| Art. 0956/P Ø 3 | Art. 0962/P Ø 8 |
| Art. 0957/P Ø 3,5 | Art. 0963/P Ø 10 |
| Art. 0958/P Ø 4 | Art. 0964/P Ø 12 |
| Art. 0959/P Ø 5 | Art. 0965/P Ø 15 |
| Art. 0960/P Ø 6 | Art. 0966/P Ø 18 |
| Art. 0961/P Ø 7 | Art. 0967/P Ø 20 |



A rotazione per graniti
 Rotation punches for granite

- | | |
|--------------------------|-------------------------|
| Art. 0955/G Ø 2,5 | Art. 0962/G Ø 8 |
| Art. 0956/G Ø 3 | Art. 0963/G Ø 10 |
| Art. 0957/G Ø 3,5 | Art. 0964/G Ø 12 |
| Art. 0958/G Ø 4 | Art. 0965/G Ø 15 |
| Art. 0959/G Ø 5 | Art. 0966/G Ø 18 |
| Art. 0960/G Ø 6 | Art. 0967/G Ø 20 |
| Art. 0961/G Ø 7 | |



A rotazione per marmi
 Rotation punches for marble

- | | |
|--------------------------|-------------------------|
| Art. 0955/M Ø 2,5 | Art. 0962/M Ø 8 |
| Art. 0956/M Ø 3 | Art. 0963/M Ø 10 |
| Art. 0957/M Ø 3,5 | Art. 0964/M Ø 12 |
| Art. 0958/M Ø 4 | Art. 0965/M Ø 15 |
| Art. 0959/M Ø 5 | Art. 0966/M Ø 18 |
| Art. 0960/M Ø 6 | Art. 0967/M Ø 20 |
| Art. 0961/M Ø 7 | |



Punte a segno
 Granite and marble punches

- Art. 0968** Ø 5 x 190



Subbie a spuntare per martello pneumatico con innesto mm. 12,5

Randing elements for pneumatic hammer with hand grip mm. 12,5

- Art. 0994** Ø 8 x 200 **Art. 0995** Ø 10 x 200



Punte per pantografo Ø 10
 Bits for pantograph Ø 10

- Art. 0946**
 Tagliente a 90° / Sharp at 90°

- Art. 0946A**
 Tagliente a 30° / Sharp at 30°



Punte con attacco sds plus
 Bits with plug sds plus

- | | |
|----------------------------|-----------------------------|
| Art. 0989 Ø 4 x 100 | Art. 0952 Ø 10 x 160 |
| Art. 0947 Ø 5 x 100 | Art. 0953 Ø 10 x 200 |
| Art. 0948 Ø 6 x 120 | Art. 0954 Ø 12 x 160 |
| Art. 0949 Ø 6 x 150 | Art. 0986 Ø 12 x 200 |
| Art. 0950 Ø 8 x 120 | Art. 0987 Ø 12 x 250 |
| Art. 0951 Ø 8 x 150 | Art. 0988 Ø 12 x 300 |

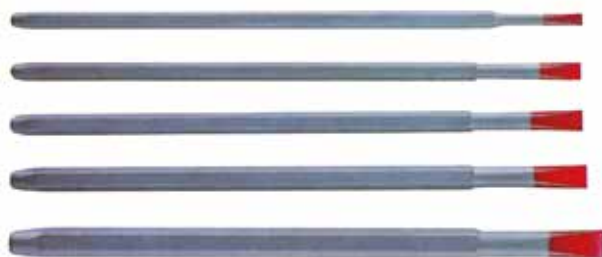

SCALPELLI A MANO PER MARMO:
(Hand chisels)

- Art. 0969 - Ø 4
- Art. 0970 - Ø 5
- Art. 0971 - Ø 6
- Art. 0972 - Ø 7
- Art. 0973 - Ø 8
- Art. 0974 - Ø 10
- Art. 0975 - Ø 12
- Art. 0976 - Ø 15
- Art. 0977 - Ø 18
- Art. 0978 - Ø 20



**SCALPELLI PER MARTELLINO PNEUMATICO
CON INNESTO MM. 12,5 PER GRANITO E
MARMO:**

(Bit for pneumatic hammer with cluth mm. 12,5)

- Art. 0969G - Ø 4
- Art. 0970G - Ø 5
- Art. 0979 - Ø 6
- Art. 0980 - Ø 8
- Art. 0981 - Ø 10
- Art. 0982 - Ø 12
- Art. 0983 - Ø 15
- Art. 0984 - Ø 18
- Art. 0985 - Ø 20



BULINATORE PER GRANITO A PERCUSSIONE:

- Art. 0996

BOCCIARDE PER MARTELLINO PNEUMATICO con attacco cilindrico mm 12,5



- Art. 6000
25 a 5 denti
- Art. 6001
20 a 9 denti
- Art. 6002
20 a 12 denti
- Art. 6003
25 a 12 denti



- Art. 6004
20 a 9 denti
- Art. 6005
20 a 16 denti
- Art. 6006
20 a 25 denti
- Art. 6007
20 a 12 denti



con gambo intercambiabile

- Art. 6008
25 a 16 denti
- Art. 6009
25 a 25 denti
- Art. 6010
30 a 16 denti
- Art. 6011
30 a 25 denti

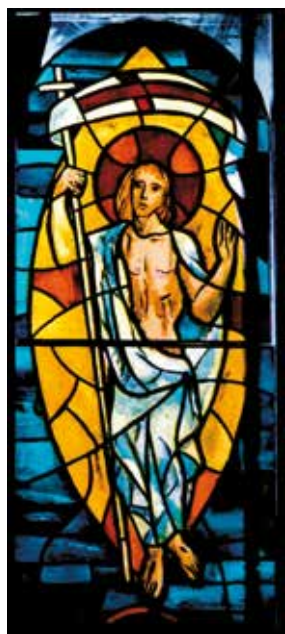

N.20



N.46



N.47



N.49

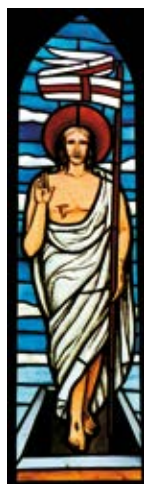

N.26



N.13



N.50



N.48



N.51



N.12



N.17



N.16



N.11



N.43

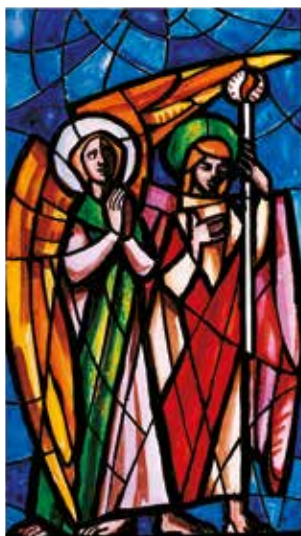

N.42



N.14



N.45



N.41



N.40



N.19

Art. 4969 ■■

Vetrata completa di telaio in ferro verniciato per la legatura della stessa. Chiedere preventivo.



N.44

Art. 4968 ■■

Vetrata con particolari in vetro rosso rubino completa di telaio in ferro verniciato per la legatura della stessa. Chiedere preventivo.

VETRATE ARTISTICHE LEGATE IN PIOMBO

Vetratae artistiche dipinte a mano con colori vetrificabili a mezzo cottura a gran fuoco. Le formelle decorate vengono legate in piombo passate e saldate nelle giunture con stagno; il pannello così formato viene pastinato con mastice speciale per dare rigidità e impermeabilità all'insieme.

I colori raffigurati sono approssimativi:

- Preventivi, bozzetti e chiarimenti verranno eseguiti senza alcun impegno.
- La vetrata viene fornita completa di supporto in ferro verniciato nero (L 25 x 15) pronta da inserire nel telaio finestra.

Per l'ordinazione è necessario, oltre alle dimensioni, anche il disegno.

Le vetratae sagomate verranno misurate nella maggiore altezza.

- I formati raffigurati in catalogo sono solo indicativi.
- PER VETRATA A TELAIO FINESTRA CHIEDERE PREVENTIVO.

NB: Le vetratae con superficie inferiori al mq. vengono conteggiate 1 mq.

All'ordinazione delle vetratae è necessario un versamento in acconto pari al 50% del costo totale.

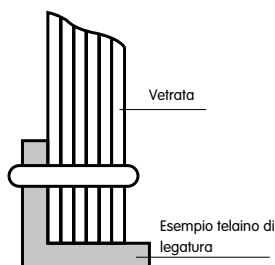
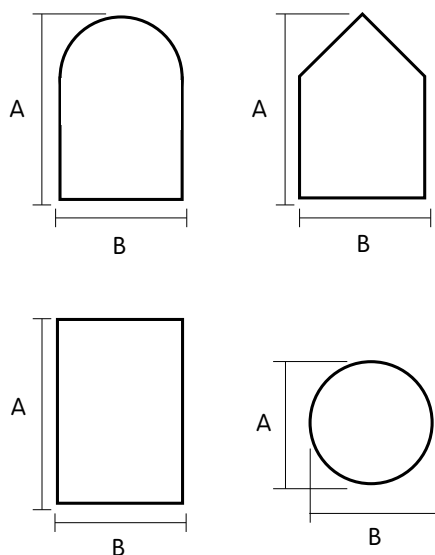

Il costo della vetrata viene rilevato calcolando le misure di ingombro (vedi esempio) $A \times B = \text{mq}$.

la Porcellana

Marmorizzato botticino

Marmorizzato bianco carrara

Porcellana bianca

Porcellana botticino

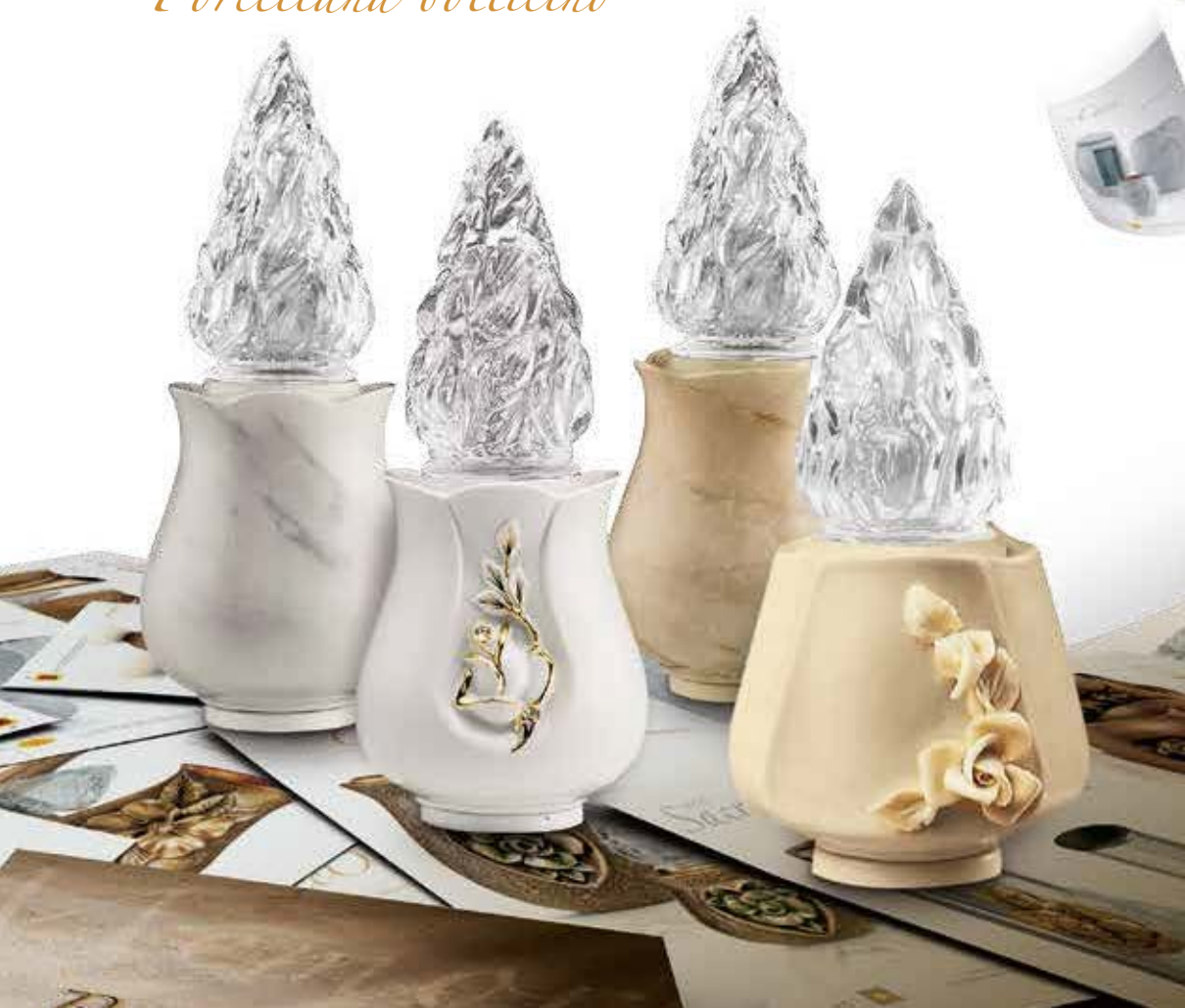



Art. 7426 - h. 1,5

● ** Æ Þ Ð Æ Ø

Art. 7468 - h. 2,5

● ** Æ Þ Ð Æ Ø

Art. 7469 - h. 3

● ** Æ Þ Ð Æ Ø

Art. 7470 - h. 4

● Æ Þ Ð Æ Ø

Art. 7471 - h. 5

● Æ Þ Ð Æ Ø

Art. 7472 - segni

NB: Le lettere sono in "bronzo" cubicate new botticino.

Per quantità inferiori alla confezione e forniture di dicitura, aumento del 20% fino a 6 cm.

Legenda simboli: ● Lettere / * Numeri / ✱ Stelle - Æ (65) - Þ (59) - Ð (71) - L (72) - Ø (73)

20% surcharge for any order less than the minimum requirement and for specific words up to 6 cm.

Symbols: ● Letters / * Figures / ✱ Stars - Æ (65) - Þ (59) - Ð (71) - L (72) - Ø (73)



Art. 6746M2

h. 20,5 x 12 x 12,5 R/93**B



Art. 6751M2

h. 20 x 10 x 10,5 F/02



Art. 6749M2

h. 19 x 16 x 11,5 R/A3B

Art. 6747M2

h. 20,5 x 12 R/93**B

Art. 6752M2

h. 20 x 10 F/02

Art. 6750M2

h. 19 x 16 x 11 R/A3B

Art. 6748M2

h. 29 x 15,5 R/88-BB

Art. 6753M2

h. 27 x 11,5 F/03



■ **Art. 6648M2 (ossario)**
h. 13 x 8 x 8 P/75B



■ **Art. 6650M2 (ossario)**
h. 14 x 6,5 x 6,5 F/01



■ **Art. 6575M2**
h. 18 x 18 x 13 R/A3B



■ **Art. 6597M2**
h. 20 x 13 x 13 B/13

■ **Art. 6576M2**
h. 20 x 12 x 13 R/93**B

■ **Art. 6577M2**
h. 20 x 9 x 9 F/02

■ **Art. 6578M2**
h. 18 x 18 x 12 R/A3B

■ **Art. 6598M2**
h. 20 x 13 x 12 B/13

■ **Art. 6649M2 (ossario)**
h. 13 x 8 P/75B

■ **Art. 6651M2 (ossario)**
h. 14 x 6,5 F/01

■ **Art. 6579M2**
h. 20 x 12 R/93**B

■ **Art. 6580M2**
h. 20 x 9 F/02

■ **Art. 6581M2**
h. 30 x 15 R/88-AB



■ **Art. 6570M2**
h. 18 x 19 x 12 R/A3B



■ **Art. 6569M2**
h. 20 x 12 x 10 F/02



■ **Art. 6571M2**
h. 18 x 33 x 17 R/73-A

■ **Art. 6573M2**
h. 18 x 19 x 11 R/A3B

■ **Art. 6572M2**
h. 20 x 12 x 9 F/02

■ **Art. 6574M2**
h. 18 x 33 x 16 R/73-A



■ **Art. 6537M2**
9 x 12

■ **Art. 6538M2**
10 x 15



■ **Art. 6629M2**
8 x 10

■ **Art. 6535M2**
9 x 12

■ **Art. 6536M2**
11 x 15

◆ Serie Delpbi



■ Art. 6683M2
h. 22 x 14 x 10 F/02

(sezione ☺)



■ Art. 6682M2
h. 19 x 20 x 13 R/A3B

(sezione ☺)

◆ Serie Alisea



■ Art. 6685M2
h. 20 x 10 x 9 F/02

(sezione ☺)



■ Art. 6686M2
h. 19 x 19,5 x 12 R/A3B

(sezione ☺)

◆ Serie Limoges



■ Art. 6695M2
h. 19,5 x 12 R/20

■ Art. 6696M2
h. 19,5 x 11 R/20

■ Art. 6709M2
h. 30 x 16 R/78



■ Art. 6698M2
h. 19 x 9 F/02

■ Art. 6697M2
h. 19 x 8,5 F/02

■ Art. 6716M2
h. 26 x 11 F/03



■ Art. 6700M2
h. 16 x 15,5 x 11
R/A3B

■ Art. 6699M2
h. 17 x 15,5 x 10,5
R/A3B



Art. 7588 - h. 1,5

●**ÆÐÐLØ

Art. 7463 - h. 2,5

●**ÆÐÐLØ

Art. 7464 - h. 3

●**ÆÐÐLØ

Art. 7465 - h. 4

●ÆÐÐLØ

Art. 7466 - h. 5

●ÆÐÐLØ

Art. 7467 - segni

NB: Le lettere sono in "bronzo" cubicate bianco carrara.

Per quantità inferiori alla confezione e forniture di diciture, aumento del 20% fino a 6 cm.

Legenda simboli: ● Lettere / * Numeri / ✱ Stelle - Croci - Æ (65) - Þ (59) - Ð (71) - L (72) - Ø (73)

20% surcharge for any order less than the minimum requirement and for specific words up to 6 cm.

Symbols: ● Letters / * Figures / ✱ Stars - Crosses - Æ (65) - Þ (59) - Ð (71) - L (72) - Ø (73)



Art. 6746M3

h. 20,5 x 12 x 12,5
R/93**Z

Art. 6747M3

h. 20,5 x 12 R/93**Z

Art. 6748M3

h. 29 x 15,5 R/88-BZ



Art. 6751M3

h. 20 x 10 x 10,5 F/02

Art. 6752M3

h. 20 x 10 F/02

Art. 6753M3

h. 27 x 11,5 F/03



Art. 6749M3

h. 19 x 16 x 11,5 R/A3Z

Art. 6750M3

h. 19 x 16 x 11 R/A3Z

◆ Serie Arianna



■ Art. 6648M3 (ossario)
h. 13 x 8 x 8 P/75Z

■ Art. 6576M3
h. 20 x 12 x 13 R/93**Z

■ Art. 6649M3 (ossario)
h. 13 x 8 P/75Z

■ Art. 6579M3
h. 20 x 12 R/93**Z

■ Art. 6581M3
h. 30 x 15 R/88-AZ



■ Art. 6650M3 (ossario)
h. 14 x 6,5 x 6,5 F/01

■ Art. 6577M3
h. 20 x 9 x 9 F/02

■ Art. 6651M3 (ossario)
h. 14 x 6,5 F/01

■ Art. 6580M3
h. 20 x 9 F/02



■ Art. 6575M3
h. 18 x 18 x 13
R/A3Z

■ Art. 6578M3
h. 18 x 18 x 12
R/A3Z



■ Art. 6597M3
h. 20 x 13 x 13
B/13

■ Art. 6598M3
h. 20 x 13 x 12
B/13

◆ Serie Luna



■ Art. 6570M3
h. 18 x 19 x 12 R/A3Z

■ Art. 6573M3
h. 18 x 19 x 11 R/A3Z



■ Art. 6569M3
h. 20 x 12 x 10 F/02

■ Art. 6572M3
h. 20 x 12 x 9 F/02



■ Art. 6571M3
h. 18 x 33 x 17 R/73-A

■ Art. 6574M3
h. 18 x 33 x 16 R/73-A



■ Art. 6537M3
9 x 12

■ Art. 6538M3
10 x 15



■ Art. 6629M3
8 x 10

■ Art. 6535M3
9 x 12

■ Art. 6536M3
11 x 15



■ Art. 6683M3
h. 22 x 14 x 10 F/02

(sezione ◡)



■ Art. 6682M3
h. 19 x 20 x 13 R/A3Z

(sezione ◡)



■ Art. 6685M3
h. 20 x 10 x 9 F/02

(sezione ◡)



■ Art. 6686M3
h. 19 x 19,5 x 12 R/A3Z

(sezione ◡)



■ Art. 6695M3
h. 19,5 x 12 R/20

■ Art. 6696M3
h. 19,5 x 11 R/20

Art. 6709M3
h. 30 x 16 R/78



■ Art. 6698M3
h. 19 x 9 F/02

■ Art. 6697M3
h. 19 x 8,5 F/02

Art. 6716M3
h. 26 x 11 F/03



■ Art. 6700M3
h. 16 x 15,5 x 11 R/A3Z

■ Art. 6699M3
h. 17 x 15,5 x 10,5 R/A3Z



Senza perni

Without pins

Art. 6582 - h. 2,5

●**x

Art. 6584 - h. 4,5

●

Art. 6586 - segni



Senza perni

Without pins

Art. 6528 - h. 2,5

●**x

Art. 6530 - h. 4,5

●

Art. 6541 - segni

Con perni

With pins

Art. 6636 - h. 2,5

●**x

Art. 6638 - h. 4,5

●

Art. 6640 - segni

Senza perni
Without pins

Art. 6612 - h. 5
maiuscole

Art. 6611 - h. 2,5
minuscole
numeri - N M

Art. 6613
segni



Art. 2724W
h. 5 - 2,5

Art. 2455W
h. 8 - 4

Art. 2723W - h. 2,5
numeri - N M - vocali sciolte

Art. 2877W - h. 4
numeri - N M - vocali sciolte

Art. 2057W - h. 2,5
segni

Art. 2888W - h. 4
segni



Art. 655101
h. 11 x 16



Art. 655102
h. 11 x 16



Art. 655103
h. 11 x 16



Art. 655104
h. 11 x 16



Art. 655105
h. 11 x 16



Art. 655106
h. 11 x 16



Art. 655107
h. 11 x 16



Art. 659202
h. 16 x 26



Art. 6551
h. 11 x 16

Art. 6592
h. 16 x 26



Art. 6542
h. 15 x 22

Art. 6543
h. 20 x 31



Art. 6670
h. 14 x 21

Art. 6671
h. 14 x 21



Art. 6623
h. 16 x 19

*Altezza lettere disponibili: minuscole h.0,6 - 1,0 - 1,2 - 1,5; maiuscole h.1,2 - 2,0 - 2,4 - 3,0.
L'altezza delle lettere sarà scelta in base al testo. Le diciture personalizzate di colore nero sono gratuite.
Engraving in black included.



Art. 6592C
h. 16 x 26 foto 9 x 12

Art. 6592N
h. 16 x 26 foto 9 x 12



Art. 6670C
h. 14 x 21 foto 8 x 10

Art. 6671C
h. 14 x 21 foto 8 x 10

Art. 6670N
h. 14 x 21 foto 8 x 10

Art. 6671N
h. 14 x 21 foto 8 x 10



Art. 6543C
h. 20 x 31 foto 10 x 13

Art. 6543N
h. 20 x 31 foto 10 x 13

Altezza lettere disponibili:
minuscole h.0,6 - 1,0 - 1,2 - 1,5;
maiuscole h.1,2 - 2,0 - 2,4 - 3,0.
L'altezza delle lettere sarà scelta in base al testo.
Le diciture personalizzate di colore nero,oro, marrone e l'immagine fotografica sono incluse.

Caratteri disponibili: CD e BM.

Immagine fotografica:

"C" a colori
"N" in Bianco e Nero

Picture:

"C" colours
"N" Black and White



Art. 6537
9 x 12



Art. 6629
8 x 10



Art. 6537CO
9 x 12



Art. 6629CO
8 x 10

Art. 6538
10 x 15

Art. 6535
9 x 12

Art. 6538CO
10 x 15

Art. 6535CO
9 x 12

Art. 6681
11 x 15

Art. 6536
11 x 15

Art. 6536CO
11 x 15



Art. 6706CO
9 x 12

Art. 6707CO
10 x 15



Art. 6703CO
8 x 10

Art. 6704CO
9 x 12

Art. 6705CO
11 x 15



Art. 6526
9 x 12



Art. 6524
9 x 12



Art. 6533
9 x 12



Art. 6531
9 x 12

Art. 6527
10 x 15

Art. 6525
11 x 15

Art. 6534
10 x 15

Art. 6532
11 x 15



Art. 6537D3
9 x 12

Art. 6538D3
10 x 15



Art. 6629D3
8 x 10

Art. 6535D3
9 x 12

Art. 6536D3
11 x 15



Art. 6706
9 x 12

Art. 6707
10 x 15



Art. 6703
8 x 10

Art. 6704
9 x 12

Art. 6705
11 x 15



Art. 6706C2
9 x 12

Art. 6707C2
10 x 15



Art. 6703C2
8 x 10

Art. 6704C2
9 x 12

Art. 6705C2
11 x 15



Art. 6706CL
9 x 12

Art. 6707CL
10 x 15



Art. 6703CL
8 x 10

Art. 6704CL
9 x 12

Art. 6705CL
11 x 15



Art. 6632
9 x 12

Art. 6633
10 x 15



Art. 6630
9 x 12

Art. 6631
11 x 15



Art. 6533D
9 x 12

Art. 6534D
10 x 15



Art. 6531D
9 x 12

Art. 6532D
11 x 15

CHIAVARDE PORTANTI per spessore marmo da mm 18 a mm 22 - con perno 8 MA inox V/91F incluso nel prezzo



Art. 2910W
mm 60

Art. 2908W
mm 80

Art. 2911W
mm 44



Art. 1159W
h. 2,5

Art. 1148W
h. 4

*Art. 1239W
Ø 4

Art. 1146W
h. 3

*Art. 1149W
h. 5



Art. 6641 vasca
h. 20 x 22 x 13 R/70**Z

Art. 6642 lampada elettrica
h. 22 x 11 x 8 F/02

Art. 6629 cornice
8 x 10

Art. 6643 Placca
con epigrafe (compresa)
colore nero
h. 15 x 31 x 3

Le borchie vengono fornite con perno V/01 da mm. 50 passo 5 MA, salvo diversa descrizione. In caso di sostituzione del perno, quello dotazione verrà valutato al prezzo di listino.

* A richiesta possono essere fornite con perno fino a 10MA.



■ Art. 6802
h. 20 P/83AV

■ Art. 6808 new
h. 20 P/83AV



■ Art. 6803
h. 19 P/A3Z

■ Art. 6809 new
h. 19 P/A3Z



■ Art. 6801
h. 20 F/02

■ Art. 6807 new
h. 20 F/02



■ Art. 6805
h. 20 P/83AV

■ Art. 6811 new
h. 20 P/83AV



■ Art. 6806
h. 19 P/A14**Z

■ Art. 6812 new
h. 19 P/A14**Z



■ Art. 6804
h. 20 F/02

■ Art. 6810 new
h. 20 F/02



■ Art. 6754
h. 20,5 x 12 P/83AV

■ Art. 6755
h. 20,5 x 12 P/83AV

■ Art. 6756
h. 29 x 15,5 R/88-BZ



■ Art. 6759
h. 20 x 10 F/02

■ Art. 6760
h. 20 x 10 F/02

■ Art. 6761
h. 27 x 11,5 F/03



■ Art. 6757
h. 19 x 16 x 11,5 P/A3Z

■ Art. 6758
h. 19 x 16 P/A3Z



■ Art. 6754C1
h. 20,5 x 12 R/93**Z

■ Art. 6755C1
h. 20,5 x 12 R/93**Z

■ Art. 6756C1
h. 29 x 15,5 R/88-BZ



■ Art. 6759C1
h. 20 x 10 F/02

■ Art. 6760C1
h. 20 x 10 F/02

■ Art. 6761C1
h. 27 x 11,5 F/03



■ Art. 6757C1
h. 19 x 16 x 11,5 R/A3Z

■ Art. 6758C1
h. 19 x 16 R/A3Z



■ Art. 6762C1
h. 20 x 13 x 13 B/13

■ Art. 6763C1
h. 20 x 13 x 12 B/13



■ Art. 6537
9 x 12

■ Art. 6538
10 x 15

■ Art. 6681
11 x 15



■ Art. 6629
8 x 10

■ Art. 6535
9 x 12

■ Art. 6536
11 x 15



■ **Art. 6754CO**
h. 20,5 x 12 R/93**Z

■ **Art. 6755CO**
h. 20,5 x 12 R/93**Z

Art. 6756CO
h. 29 x 15,5 R/88-BZ



■ **Art. 6762CO**
h. 20 x 13 x 13 B/13

■ **Art. 6763CO**
h. 20 x 13 x 12 B/13



■ **Art. 6759CO**
h. 20 x 10 F/02

■ **Art. 6760CO**
h. 20 x 10 F/02

Art. 6761CO
h. 27 x 11,5 F/03



■ **Art. 6757CO**
h. 19 x 16 x 11,5 R/A3Z

■ **Art. 6758CO**
h. 19 x 16 R/A3Z



Art. 6537CO
9 x 12

Art. 6538CO
10 x 15



Art. 6629CO
8 x 10

Art. 6535CO
9 x 12

Art. 6536CO
11 x 15



■ **Art. 6764C1**
h. 20,5 x 12,5 R/93**Z

■ **Art. 6765C1**
h. 20,5 x 12,5 R/93**Z



■ **Art. 6770C1**
h. 20 x 13 x 13 B/13

■ **Art. 6771C1**
h. 20 x 13 x 12 B/13



■ **Art. 6768C1**
h. 20,5 x 10,5 F/02

■ **Art. 6769C1**
h. 20,5 x 10,5 F/02



■ **Art. 6766C1**
h. 17,5 x 18 R/A3Z

■ **Art. 6767C1**
h. 17,5 x 18 R/A3Z



Art. 6537
9 x 12

Art. 6538
10 x 15

Art. 6681
11 x 15



Art. 6629
8 x 10

Art. 6535
9 x 12

Art. 6536
11 x 15



Art. 6764CO
h. 20,5 x 12,5 R/93**Z

Art. 6765CO
h. 20,5 x 12,5 R/93**Z



Art. 6770CO
h. 20 x 13 x 13 B/13

Art. 6771CO
h. 20 x 13 x 12 B/13



Art. 6768CO
h. 20,5 x 10,5 F/02

Art. 6769CO
h. 20,5 x 10,5 F/02



Art. 6766CO
h. 17,5 x 18 R/A3Z

Art. 6767CO
h. 17,5 x 18 R/A3Z



Art. 6537CO
9 x 12

Art. 6538CO
10 x 15



Art. 6629CO
8 x 10

Art. 6535CO
9 x 12

Art. 6536CO
11 x 15



Art. 6772C2
h. 21 x 11 R/93**Z

Art. 6773C2
h. 21 x 11 R/93**Z



Art. 6778C2
h. 20 x 13 x 13 B/13

Art. 6779C2
h. 20 x 13 x 12 B/13



Art. 6776C2
h. 20 x 9,5 F/02

Art. 6777C2
h. 20 x 9,5 F/02



Art. 6774C2
h. 17 x 16,5 x 11 R/A3Z

Art. 6775C2
h. 17 x 16,5 x 11 R/A3Z



Art. 6706C2
9 x 12

Art. 6707C2
10 x 15



Art. 6703C2
8 x 10

Art. 6704C2
9 x 12

Art. 6705C2
11 x 15



Art. 6772CO
h. 21 x 11 R/93**Z

Art. 6773CO
h. 21 x 11 R/93**Z



Art. 6778CO
h. 20 x 13 x 13 B/13

Art. 6779CO
h. 20 x 13 x 12 B/13



Art. 6776CO
h. 20 x 9,5 F/02

Art. 6777CO
h. 20 x 9,5 F/02



Art. 6774CO
h. 17 x 16,5 x 11 R/A3Z

Art. 6775CO
h. 17 x 16,5 x 11 R/A3Z



Art. 6706CO
9 x 12

Art. 6707CO
10 x 15



Art. 6703CO
8 x 10

Art. 6704CO
9 x 12

Art. 6705CO
11 x 15



Art. 6772CL
h. 21 x 11 R/93**Z

Art. 6773CL
h. 21 x 11 R/93**Z



Art. 6778CL
h. 20 x 13 x 13 B/13

Art. 6779CL
h. 20 x 13 x 12 B/13



Art. 6776CL
h. 20 x 9,5 F/02

Art. 6777CL
h. 20 x 9,5 F/02



Art. 6774CL
h. 17 x 16,5 x 11 R/A3Z

Art. 6775CL
h. 17 x 16,5 x 11 R/A3Z



Art. 6706CL
9 x 12

Art. 6707CL
10 x 15



Art. 6703CL
8 x 10

Art. 6704CL
9 x 12

Art. 6705CL
11 x 15



■ **Art. 6746**
h. 20,5 x 12 x 12,5 R/93**Z



■ **Art. 6751**
h. 20 x 10 x 10,5 F/02



■ **Art. 6749**
h. 19 x 16 x 11,5 R/A3Z

■ **Art. 6747**
h. 20,5 x 12 R/93**Z

■ **Art. 6752**
h. 20 x 10 F/02

■ **Art. 6750**
h. 19 x 16 x 11 R/A3Z

Art. 6748
h. 29 x 15,5 R/88-BZ

Art. 6753
h. 27 x 11,5 F/03



■ **Art. 6736**
h. 20 x 12 x 13 R/97Z



■ **Art. 6737**
h. 20 x 9 x 10 F/02



■ **Art. 6735**
h. 19 x 18 x 13 R/A3Z

■ **Art. 6739**
h. 20 x 12 R/97Z

■ **Art. 6740**
h. 20 x 9 F/02

■ **Art. 6738**
h. 19 x 18 R/A3Z

Art. 6745
h. 28 x 10 R/B3Z



Art. 6570
h. 18 x 19 x 12 R/A3Z

Art. 6573
h. 18 x 19 x 11 R/A3Z



Art. 6597
h. 20 x 13 x 13 B/13

Art. 6598
h. 20 x 13 x 12 B/13



Art. 6571
h. 18 x 33 x 17 R/73-A

Art. 6574
h. 18 x 33 x 16 R/73-A



Art. 6569
h. 20 x 12 x 10 F/02

Art. 6572
h. 20 x 12 x 9 F/02



Art. 6537
9 x 12

Art. 6538
10 x 15

Art. 6681
11 x 15



Art. 6629
8 x 10

Art. 6535
9 x 12

Art. 6536
11 x 15



Art. 6570D7
h. 18 x 19 x 12 R/A3Z

Art. 6573D7
h. 18 x 19 x 11 R/A3Z



Art. 6597D7
h. 20 x 13 x 13 B/13

Art. 6598D7
h. 20 x 13 x 12 B/13



Art. 6571D7
h. 18 x 33 x 17 R/73-A

Art. 6574D7
h. 18 x 33 x 16 R/73-A



Art. 6569D7
h. 20 x 12 x 10 F/02

Art. 6572D7
h. 20 x 12 x 9 F/02



Art. 6537
9 x 12

Art. 6538
10 x 15

Art. 6681
11 x 15



Art. 6629
8 x 10

Art. 6535
9 x 12

Art. 6536
11 x 15



Art. 6570D3
h. 18 x 19 x 12 R/A3Z

Art. 6573D3
h. 18 x 19 x 11 R/A3Z



Art. 6597D3
h. 20 x 13 x 13 B/13

Art. 6598D3
h. 20 x 13 x 12 B/13



Art. 6571D3
h. 18 x 33 x 17 R/73-A

Art. 6574D3
h. 18 x 33 x 16 R/73-A



Art. 6569D3
h. 20 x 12 x 10 F/02

Art. 6572D3
h. 20 x 12 x 9 F/02



Art. 6537D3
9 x 12

Art. 6538D3
10 x 15



Art. 6629D3
8 x 10

Art. 6535D3
9 x 12

Art. 6536D3
11 x 15



Art. 6675
h. 21 x 14 x 13 R/93**Z

Art. 6676
h. 21 x 14 x 13 R/93**Z



Art. 6701
h. 20 x 11 x 10 F/02

Art. 6702
h. 20 x 11 x 10 F/02



Art. 6672
h. 20 x 19 x 14 R/70** Z

Art. 6673
h. 20 x 19 x 14 R/70** Z



Art. 6706
9 x 12

Art. 6707
10 x 15



Art. 6703
8 x 10

Art. 6704
9 x 12

Art. 6705
11 x 15

Le rose sono realizzate a mano.
Hand-made roses.

◆ Serie Viola (decorata a mano)



■ Art. 6503D
h. 20 x 19 x 12 R/A3Z



■ Art. 6505D
h. 20 x 12 x 10 F/02



■ Art. 6501D
h. 21,5 x 33 x 17 R/73-A

■ Art. 6504D
h. 20 x 19 x 11 R/A3Z

■ Art. 6506D
h. 20 x 12 x 9 F/02

■ Art. 6502D
h. 21,5 x 33 x 16 R/73-A



Art. 6533D
9 x 12

Art. 6534D
10 x 15



Art. 6531D
9 x 12

Art. 6532D
11 x 15

◆ Serie Viola oro (decorata a mano)



■ Art. 6503
h. 20 x 19 x 12 R/A3Z



■ Art. 6505
h. 20 x 12 x 10 F/02



■ Art. 6501
h. 21,5 x 33 x 17 R/73-A

■ Art. 6504
h. 20 x 19 x 11 R/A3Z

■ Art. 6506
h. 20 x 12 x 9 F/02

■ Art. 6502
h. 21,5 x 33 x 16 R/73-A



Art. 6533
9 x 12

Art. 6534
10 x 15



Art. 6531
9 x 12

Art. 6532
11 x 15



Art. 6682
h. 19 x 20 x 13 R/A3Z

(sezione ▼)



Art. 6683
h. 22 x 14 x 10 F/02

(sezione ▼)



Art. 6682D
h. 19 x 20 x 13 R/A3Z

(sezione ▼)



Art. 6683D
h. 22 x 14 x 10 F/02

(sezione ▼)



Art. 6686
h. 19 x 19,5 x 12
R/A3Z

(sezione ▼)



Art. 6685
h. 20 x 10 x 9
F/02

(sezione ▼)

◆ Serie Ulivo oro (decorata a mano)



■ Art. 6519
h. 21,5 x 15 x 13
R/93**Z



■ Art. 6517
h. 20 x 10,5 x 9
F/02



■ Art. 6515
h. 17,5 x 21 x 13
R/70**Z



■ Art. 6507
h. 21 x 16 x 13
M/41-8

■ Art. 6520
h. 21,5 x 15 x 13
R/93**Z

■ Art. 6518
h. 20 x 10,5 x 9
F/02

■ Art. 6516
h. 17,5 x 21 x 13
R/70**Z

■ Art. 6508
h. 21 x 16 x 13
M/41-8

■ Art. 6556
h. 30 x 19 x 14
R/88-BZ



■ Art. 6526
9 x 12



■ Art. 6524
9 x 12

■ Art. 6527
10 x 15

■ Art. 6525
11 x 15

◆ Serie Madreperla (decorata a mano)



■ Art. 6644
h. 20 x 17 x 12 R/93**Z



■ Art. 6645
h. 19 x 10 x 8 F/02



■ Art. 6652
h. 20 x 13 x 13 B/13

■ Art. 6646
h. 20 x 17 x 12 R/93**Z

■ Art. 6647
h. 19 x 10 x 8 F/02

■ Art. 6653
h. 20 x 12 x 12 B/13



■ Art. 6632
9 x 12



■ Art. 6630
9 x 12

■ Art. 6633
10 x 15

■ Art. 6631
11 x 15



■ **Art. 6648 (ossario)**
h. 13 x 8 x 8 P/75Z

■ **Art. 6576**
h. 20 x 12 x 13 R/93**Z

■ **Art. 6649 (ossario)**
h. 13 x 8 x 8 P/75Z

■ **Art. 6579**
h. 20 x 12 x 13 R/93**Z

■ **Art. 6581**
h. 30 x 15 R/88-AZ



■ **Art. 6650 (ossario)**
h. 14 x 6,5 x 6,5 F/01

■ **Art. 6577**
h. 20 x 9 x 9 F/02

■ **Art. 6651 (ossario)**
h. 14 x 6,5 x 6,5 F/01

■ **Art. 6580**
h. 20 x 9 x 9 F/02



■ **Art. 6575**
h. 18 x 18 x 13 R/A3Z

■ **Art. 6578**
h. 18 x 18 x 13 R/A3Z



■ **Art. 6595**
h. 20 x 13 x 13 B/13

■ **Art. 6596**
h. 20 x 13 x 12 B/13



■ **Art. 6513**
h. 21 x 14 x 12 R/93**Z

■ **Art. 6514**
h. 21 x 14 x 12 R/93**Z



■ **Art. 6511**
h. 20 x 11 x 9 F/02

■ **Art. 6512**
h. 20 x 11 x 9 F/02



■ **Art. 6509**
h. 20 x 19 x 13 R/70**Z

■ **Art. 6510**
h. 20 x 19 x 13 R/70**Z



■ **Art. 6695**
h. 19,5 x 12 R/20

■ **Art. 6696**
h. 19,5 x 11 R/20

Art. 6709
h. 30 x 16 R/78



■ **Art. 6698**
h. 19 x 9 F/02

■ **Art. 6697**
h. 19 x 8,5 F/02

Art. 6716
h. 26 x 11 F/03



■ **Art. 6669**
h. 15 x Ø 21 R/A1 G/10P



■ **Art. 6700**
h. 16 x 15,5 x 11 R/A3Z

■ **Art. 6699**
h. 17 x 15,5 x 10,5 R/A3Z



Art. 6537
9 x 12

Art. 6538
10 x 15

Art. 6681
11 x 15



Art. 6629
8 x 10

Art. 6535
9 x 12

Art. 6536
11 x 15



■ **Art. 6684**
h. 18 x Ø 30 R/66



Art. 6634C
h. 28,7 x 19



Art. 6783C
h. 25 x 14



Art. 6624C
h. 15 x 10



Art. 6545C
h. 21 x 14



Art. 6548C
h. 17 x 9

Art. 6609C
h. 22 x 15



Art. 6544C
h. 21 x 12



Art. 6674C
h. 21 x 17



Art. 6677C
h. 33 x 16



Art. 6674
h. 21 x 17



Art. 6544
h. 21 x 12



Art. 6594
h. 13 x 7

Art. 6610
h. 22 x 14



Art. 6679
h. 33 x 30



Art. 6529
h. 36 x 37



Art. 6687
h. 28 x 18



Art. 6545
h. 21 x 14



Art. 6624 **Art. 6609**
h. 15 x 10 h. 22 x 15



Art. 6625
h. 15 x 10



Art. 6548
h. 17 x 9



Art. 6540
h. 17 x 9



Art. 6521
h. 25 x 14

disponibile senza filo oro
Art. 6783
Without gold line



Art. 6546
h. 23 x 16



Art. 6539
h. 34 x 26



Art. 6549
h. 23 x 19



Art. 6626
h. 16 x 5,5



Art. 6627
h. 16 x 5,5



Art. 6628
h. 21 x 12

Art. 6547
h. 20,5 x 10,5

Art. 6523
h. 20,5 x 10,5



Art. 6626M2
marmorizzato
Bolficino
h. 16 x 5,5



Art. 6626M3
marmorizzato
Bianco Carrara
h. 16 x 5,5



Art. 6677
h. 33 x 16



Art. 6659
h. 42 x 30 x 7



Art. 6639
h. 36 x 45



Art. 6634
h. 28,7 x 19



Art. 6593
h. 20 x 16



Art. 6678
h. 26 x 40



Art. 6619
h. 43 x 27



Art. 6688
h. 45 x 12



Art. 6635
h. 43,5 x 13



■ **Art. 6614**
h. 51 x 22

■ **Art. 6615**
h. 45 x 22



■ **Art. 6522**
h. 52 x 11,5



■ **Art. 6655**
h. 33 x 13

■ **Art. 6654**
h. 33 x 13



■ **Art. 6663**
h. 33 x 13

■ **Art. 6664**
h. 33 x 13



■ **Art. 6637**
h. 12 x 12

■ **Art. 6680**
h. 34 x 30



■ **Art. 6668**
h. 40 x 12 - base 30

Senza perni

Without pins

Art. 6587 - h. 2,5

● * x

Art. 6589 - h. 4,5

●

Art. 6591 - segni



Senza perni

Without pins

Art. 6550 - h. 2,5

● * x

Art. 6552 - h. 4,5

●

Art. 6554 - segni

Con perni

With pins

Art. 6656 - h. 2,5

● * x

Art. 6658 - h. 4,5

●

Art. 6660 - segni





Senza perni

Without pins

Art. 6617 - h. 5
maiuscole

Art. 6616 - h. 2,5
minuscole
numeri - N M

Art. 6618
segni

Salvatore Angelo
17 11 1922

Art. 2724B
h. 5 - 2,5

Art. 2723B - h. 2,5
numeri - N M - vocali sciolte

Art. 2057B
h. 2,5 - segni

Art. 2455B
h. 8 - 4

Art. 2877B - h. 4
numeri - N M - vocali sciolte

Art. 2888B
h. 4 - segni



Art. 655101B
h. 11 x 16



Art. 655102B
h. 11 x 16



Art. 655103B
h. 11 x 16



Art. 655104B
h. 11 x 16



Art. 655105B
h. 11 x 16



Art. 655106B
h. 11 x 16



Art. 655107B
h. 11 x 16

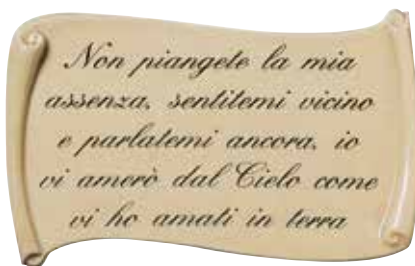

Art. 659202B
h. 16 x 26



Art. 6551B
h. 11 x 16

Art. 6592B
h. 16 x 26



Art. 6542B
h. 15 x 22

Art. 6543B
h. 20 x 31



Art. 6670B
h. 14 x 21

Art. 6671B
h. 14 x 21



Art. 6623B
h. 16 x 19

*Altezza lettere disponibili: minuscole h.0,6 - 1,0 - 1,2 - 1,5; maiuscole h.1,2 - 2,0 - 2,4 - 3,0.
L'altezza delle lettere sarà scelta in base al testo. Le diciture personalizzate di colore nero sono gratuite.
Engraving in black included.



Art. 6537B
9 x 12

Art. 6538B
10 x 15



Art. 6629B
8 x 10

Art. 6536B
11 x 15



Art. 6706B
9 x 12

Art. 6707B
10 x 15



Art. 6703B
8 x 10

Art. 6705B
11 x 15



Art. 6526B
9 x 12

Art. 6527B
10 x 15



Art. 6524B
9 x 12

Art. 6525B
11 x 15



Art. 6533B
9 x 12

Art. 6534B
10 x 15



Art. 6531B
9 x 12

Art. 6532B
11 x 15



Art. 6533BD
9 x 12

Art. 6534BD
10 x 15



Art. 6531BD
9 x 12

Art. 6532BD
11 x 15



Art. 6632B
9 x 12

Art. 6633B
10 x 15



Art. 6630B
9 x 12

Art. 6631B
11 x 15

CHIAVARDE PORTANTI per spessore marmo da mm 18 a mm 22 - con perno 8 MA inox V/91F **incluso nel prezzo**



Art. 2910B
mm 60

Art. 2908B
mm 80



Art. 2911B
mm 44



Art. 1159B
h. 2,5

Art. 1148B
h. 4

Art. 1146B
h. 3

***Art. 1149B**
h. 5



***Art. 1239B**
Ø 4

Le borchie vengono fornite con perno V/01 da mm. 50 passo 5 MA, salvo diversa descrizione.
In caso di sostituzione del perno, quello in dotazione verrà valutato al prezzo di listino.

*A richiesta possono essere fornite con perno fino a 10 MA.



■ **Art. 6736B**
h. 20 x 12 x 13 R/97B



■ **Art. 6737B**
h. 20 x 9 x 10 F/02



■ **Art. 6735B**
h. 19 x 18 x 13 R/A3B

■ **Art. 6739B**
h. 20 x 12 R/97B

■ **Art. 6740B**
h. 20 x 9 F/02

■ **Art. 6738B**
h. 19 x 18 R/A3B

Art. 6745B
h. 28 x 10 R/B3B



Art. 6537B
9 x 12

Art. 6538B
10 x 15



Art. 6629B
8 x 10

Art. 6535B
9 x 12

Art. 6536B
11 x 15



■ **Art. 6684B**
h. 18 x Ø 30 R/66



■ **Art. 6686B**
h. 19 x 19,5 x 12 R/A3B

(sezione ◡)



■ **Art. 6685B**
h. 20 x 10 x 9 F/02

(sezione ◡)



■ **Art. 6519B**
h. 21,5 x 15 x 13
R/93**B



■ **Art. 6517B**
h. 20 x 10,5 x 9
F/02



■ **Art. 6515B**
h. 17,5 x 21 x 13
R/70**B



■ **Art. 6507B**
h. 21 x 16 x 13
M/41-8

■ **Art. 6520B**
h. 21,5 x 15 x 13
R/93**B

■ **Art. 6518B**
h. 20 x 10,5 x 9
F/02

■ **Art. 6516B**
h. 17,5 x 21 x 13
R/70**B

■ **Art. 6508B**
h. 21 x 16 x 13
M/41-8

Art. 6556B
h. 30 x 19 x 14
R/88-BB



Art. 6526B
9 x 12



Art. 6524B
9 x 12

Art. 6527B
10 x 15

Art. 6525B
11 x 15



■ **Art. 6644B**
h. 20 x 17 x 12 R/93**B



■ **Art. 6645B**
h. 19 x 10 x 8 F/02



■ **Art. 6652B**
h. 20 x 13 x 13 B/13

■ **Art. 6646B**
h. 20 x 17 x 12 R/93**B

■ **Art. 6647B**
h. 19 x 10 x 8 F/02

■ **Art. 6653B**
h. 20 x 13 x 12 B/13



Art. 6632B
9 x 12



Art. 6630B
9 x 12

Art. 6633B
10 x 15

Art. 6631B
11 x 15

◆ Serie Viola (decorata a mano)



■ Art. 6503BD
h. 20 x 19 x 12 R/A3B



■ Art. 6505BD
h. 20 x 12 x 10 F/02



■ Art. 6501BD
h. 21,5 x 33 x 17 R/73-A

■ Art. 6504BD
h. 20 x 19 x 11 R/A3B

■ Art. 6506BD
h. 20 x 12 x 9 F/02

■ Art. 6502BD
h. 21,5 x 33 x 16 R/73-A



Art. 6533BD
9 x 12

Art. 6534BD
10 x 15



Art. 6531BD
9 x 12

Art. 6532BD
11 x 15

◆ Serie Vela decorata



■ Art. 6513B
h. 21 x 14 x 12
R/93**B



■ Art. 6511B
h. 20 x 11 x 9
F/02



■ Art. 6509B
h. 20 x 19 x 13
R/70**B

■ Art. 6514B
h. 21 x 14 x 12
R/93**B

■ Art. 6512B
h. 20 x 11 x 9
F/02

■ Art. 6510B
h. 20 x 19 x 13
R/70**B



■ **Art. 6503B**
h. 20 x 19 x 12 R/A3B



■ **Art. 6505B**
h. 20 x 12 x 10 F/02



■ **Art. 6501B**
h. 21,5 x 33 x 17 R/73-A

■ **Art. 6504B**
h. 20 x 19 x 11 R/A3B

■ **Art. 6506B**
h. 20 x 12 x 9 F/02

■ **Art. 6502B**
h. 21,5 x 33 x 16 R/73-A



Art. 6533B
9 x 12

Art. 6534B
10 x 15



Art. 6531B
9 x 12

Art. 6532B
11 x 15



Art. 6641B vasca
h. 20 x 22 x 13 R/70**B

Art. 6642B lampada elettrica
h. 22 x 11 x 8 F/02

Art. 6629B cornice
8 x 10

Art. 6643B Placca con epigrafe (compresa)
Engraving included
Colore nero
h. 15 x 31 x 3



■ Art. 6695B
h. 19,5 x 12 R/20

■ Art. 6696B
h. 19,5 x 11 R/20

■ Art. 6709B
h. 30 x 16 R/78



■ Art. 6698B
h. 19 x 9 F/02

■ Art. 6697B
h. 19 x 8,5 F/02

■ Art. 6716B
h. 26 x 11 F/03



■ Art. 6669B
h. 15 x Ø 21 R/A1 G/10P



■ Art. 6700B
h. 16 x 15,5 x 11 R/A3B

■ Art. 6699B
h. 17 x 15,5 x 10,5 R/A3B



■ Art. 6682B
h. 19 x 20 x 13 R/A3B

(sezione ☺)



■ Art. 6683B
h. 22 x 14 x 10 F/02

(sezione ☺)



■ **Art. 6675B**
h. 21 x 14 x 13 R/93**B

■ **Art. 6676B**
h. 21 x 14 x 13 R/93**B



■ **Art. 6701B**
h. 20 x 11 x 10
F/02

■ **Art. 6702B**
h. 20 x 11 x 10
F/02



■ **Art. 6672B**
h. 20 x 19 x 14
R/70**B

■ **Art. 6673B**
h. 20 x 19 x 14
R/70**B



Art. 6706B
9 x 12

Art. 6707B
10 x 15



Art. 6703B
8 x 10

Art. 6704B
9 x 12

Art. 6705B
11 x 15

Le rose sono realizzate a mano.
Hand-made roses.



■ **Art. 6682BD**
h. 19 x 20 x 13 R/A3B

(sezione ◡)



■ **Art. 6683BD**
h. 22 x 14 x 10 F/02

(sezione ◡)



◆ Applicazioni



Art. 6674B
h. 21 x 17



Art. 6544B
h. 21 x 12



Art. 6594B
h. 13 x 7

Art. 6610B
h. 22 x 14



Art. 6679B
h. 33 x 30



Art. 6529B
h. 36 x 37



Art. 6687B
h. 28 x 18



Art. 6545B
h. 21 x 14



Art. 6624B **Art. 6609B**
h. 15 x 10 h. 22 x 15



Art. 6625B
h. 15 x 10



Art. 6548B
h. 17 x 9



Art. 6540B
h. 17 x 9



Art. 6521B
h. 25 x 14



Art. 6546B
h. 23 x 16



Art. 6539B
h. 34 x 26



Art. 6549B
h. 23 x 19



Art. 6626B
h. 16 x 5,5



Art. 6627B
h. 16 x 5,5



Art. 6628B
h. 21 x 12

Art. 6547B
h. 20,5 x 10,5

Art. 6523B
h. 20,5 x 10,5



Art. 6677B
h. 33 x 16



Art. 6659B
h. 42 x 30 x 7



Art. 6634B
h. 28,7 x 19



Art. 6593B
h. 20 x 16



Art. 6678B
h. 26 x 40



Art. 6619B
h. 43 x 27



Art. 6688B
h. 45 x 12



Art. 6635B
h. 43,5 x 13



Art. 6614B
h. 51 x 22

Art. 6615B
h. 45 x 22



Art. 6522B
h. 52 x 11,5



Art. 6655B
h. 33 x 13

Art. 6654B
h. 33 x 13



Art. 6663B
h. 33 x 13

Art. 6664B
h. 33 x 13



Art. 6637B
h. 12 x 12

Art. 6680B
h. 34 x 30



Art. 6668B
h. 40 x 12 - base 30

Un'azienda familiare con la passione per l'Eccellenza, la Qualità e l'Innovazione



REP. STAMPI



REP. STAMPI



REP. FONDERIA A PRESSO FUSIONE



REP. FONDERIA A PRESSO FUSIONE



REP. ASSEMBLAGGIO BRONZO



REP. SALDATURA BRONZO



REP. SPAZZOLATURA



REP. SPAZZOLATURA LETTERE



REP. PREPARAZIONE VERNICIAURA

BIONDAN
ESTABLISHED 1956

BIONDAN · Sede di Montorio, Verona · IT

Area produttiva 19.000 mq
Superficie totale 56.000 mq

A World-Wide Group with passion for Excellence, Quality and Innovation



REP. PREPARAZIONE VERNICIATURA



REP. VERNICIATURA A POLVERI



REP. VERNICIATURA A POLVERI



REP. VERNICIATURA A LIQUIDO



REP. VERNICIATURA A LIQUIDO



REP. CONFEZIONI



REP. CONFEZIONI



MAGAZZINO

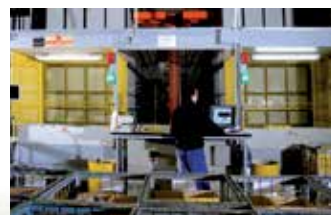

MAGAZZINO



INDICE ANALITICO
INDEX

www.biondan.it

Codice Articolo	Euro	Pag List	Codice Articolo	Euro	Pag List	Codice Articolo	Euro	Pag List
0S64		395	0062G	..	453	01362SAT		416
0S65		395	0062H	..	453	01371SAT		416
0S66		395	0063	..	453	01381		411
0S93		395	0063A	..	453	01382		411
0001		393	0063B	..	453	0143		398
0002		393	0063D	..	453	0144		398
0003		393	0063E	..	453	0165		397
0004		393	0063H	..	453	0166		397
0005		392	0064		395	0167		397
0006		392	0065		395	0168		397
0007		392	0066		395	0169		400
0008		392	0067		396	0173		400
0009		392	0068		396	0174		400
0010		392	0069		396	0175		400
0011		392	0070		396	0176		400
0012		392	0071		396	0177		400
0013		392	0072		396	0178		400
0014		392	0073		395	0179		400
0015		392	0074		395	0180		400
0017		400	0076		397	0181		400
0018		395	0077		397	0183		400
0019		392	0078		397	0184		400
0020		392	0079		397	0185		400
0021M	..	407	0080		397	0186		400
002228	..	407	0082		397	0187		400
0023		393	0083		397	0189		400
0024		393	0085		397	0190		400
0025		393	0086		397	0191		400
0026		393	0087		397	0192		400
0028	.	394	0088		397	0193		400
0029	.	394	0092		395	0195		400
0030	.	394	0093		395	0196		400
0031	.	394	0094		395	0202		399
0032	.	394	0095		395	0203		399
0033	.	394	0096		395	0204		425
0034	.	394	009708		400	0209	..	398
0035	.	394	009710	..	400	0210	..	398
0037		396	0098		395	0211		425
0038		396	0099		395	0212		399
0039		396	0103		397	0213		424
0040		396	0107		395	02131A		426
0041		396	01081		F/C	0214		424
0042		396	01081M		411	02141A		426
0043		396	0109		395	0216		425
0044		398	0110		395	0217		425
0044SAT		398	0113MSAT		406	0218		424
0045		398	0114SAT		406	021830		424
0045SAT		398	0116		406	021840		424
0046		398	0116SAT		406	0219		424
0046SAT		398	0117SAT		406	021930		424
0047		398	0119MSAT		412	021940		424
0047SAT		398	0121 P		417	0221		423
0048		398	0122SAT		406	0222		423
0049		398	0123SAT		406	0223		423
0054		398	0124SAT		406	0224		423
0055		398	0125SAT		406	0229		423
0056		398	0126MSAT		412	0230		423
0057		398	0128	..	398	023301		407
0058		396	0129	..	398	023401		407
0059		396	0130		406	023501		407
0060		396	0130SAT		406	023601		407
0061		396	0131	..	391	0237		398
0062	..	453	0133	..	391	023701		398
0062B	..	453	0134SAT1		406	0238		398
0062C	..	453	0135	..	391	023801		398
0062F	..	453	01361		416	023980SAT		426

Codice Articolo	Euro	Pag List	Codice Articolo	Euro	Pag List	Codice Articolo	Euro	Pag List
0240		398	0321		407	0454		411
024001		398	032201		F/C	0457		411
0241		398	0323		423	0459		411
024101		398	0324		423	0460	**	411
0242		410	0325		423	0461		404
0243		410	0326		423	0461AGSAT		404
0244		410	0327		412	0461SAT		404
0245		424	0333		410	046201SAT		404
024520		424	0334		409	0463		405
024530		424	0337		423	0464		405
0246		424	0338		423	0465		404
0248		409	0339		423	0466		404
0249		409	0340		423	0466SAT		404
0252		410	0341		423	0467		404
0253		410	0342		423	0468		404
0254		410	0351		422	0468SAT		404
0255		410	0352		422	0469		404
0256		403	0353		422	0469SAT		404
0256SAT		403	0358		418	0470		404
0257		403	0359		407	0470W		404
0257SAT		403	0362		416	0470WSAT		404
0258		397	0364		406	0471		411
0259		397	0364SAT		406	0473		411
0260		397	0369		418	0475		405
0261		397	0370		418	0476		405
0264		404	0376		399	0480		404
0264SAT		404	037601		399	0480 P2		NVO
0266		414	037602		399	0480 P2SAT		NVO
0271		424	037603		399	0480SAT		404
02711A		426	037604		399	0481		417
02711B		426	037609		399	0482		417
027130		424	0378	**	391	0483		404
0272		424	0380	**	391	0483SAT		404
02721A		426	0382	**	391	0484		417
02721B		426	0383	**	391	0486		417
0274		423	0384	**	391	0488		417
0275		423	0385		418	0489		417
0276		423	0386		424	0490		417
0278 P		416	0386U		424	0492		417
0279		416	0390		418	0494		417
0281		424	0392		418	0495		417
0283		404	0393		418	0496		417
0284		404	0394		418	0499		417
028570SAT		426	0395		418	0503		417
028570SAT1A		426	0397		418	0505		414
028570SAT1B		426	0414		399	0507		417
0290		409	0420		418	0509		414
0291		409	0423		407	0513		414
0292		409	0425		407	0516		414
0297		409	0426		407	0519		397
0303		410	0427		417	0520		414
030301		410	0429		418	0521		397
0304		409	0430		407	0523		414
030401		409	0431		413	0526		416
0305		423	0432		417	0527		416
0305SAT		423	0433		407	0528		418
0306		423	0434		407	0529		424
0308		409	0435		418	0530		424
0310		F/S	0437		414	0531		424
0311		412	0438		414	0533/D		422
0315		423	0439		F/C	0533/S		422
0316		423	0445		410	0534		413
0317		423	044501		410	0536		424
0318		423	0449		413	053630		424
0319		407	0451	**	399	0537		413
0320		407	0452	**	399	0538		413

Codice Articolo	Euro	Pag List	Codice Articolo	Euro	Pag List	Codice Articolo	Euro	Pag List
0539		405	0701		416	0862		411
054070SAT		426	0702		416	0862/E		412
054070SAT1A		426	0703		416	0863		419
0542		405	0706		414	0864		396
0543		405	0719		418	0865		396
0545		408	0722		413	0866		396
0545B		F/C	072818		415	0868		419
0546		408	072914		415	0873		421
0546B		F/S	0729141		415	0884		421
0547		408	0729142		415	0884F03		420
0548		408	072918		415	0884F04		420
0577		414	0729181		415	0890		421
0587		407	0729182		415	0892		421
0588		407	0730		411	0898		421
0589		407	0730/E		412	0899		421
0590		407	0731		415	0900		421
0591		403	0735		413	0913		396
0591SAT		403	0737		416	0917		422
0592		403	0741		405	0918		422
0592SAT		403	0742		405	0919		400
0593		403	0743		420	0920		400
0593SAT		403	0746		414	0921		400
0594		403	0747		414	0922		422
0594SAT		403	0748		414	0923		422
0596		403	07748001		415	0924		422
0596SAT		403	0775		411	0924SAT		422
0597		403	0779		414	0925		401
0597SAT		403	0780		414	0930		401
0598		403	0790		414	0933		422
0598SAT		403	0798		419	0934		422
0601		403	0799 R		408	0939		401
0601SAT		403	0800 R		408	0940		401
0609		421	0800SAT		406	0943		402
0612 R	..	408	0801		413	0944		402
0615 R	..	408	0802		413	0946		464
0616 R	..	408	0804		413	0946A		464
0617	..	408	0806		402	0947		464
0618	..	423	0807		402	0948		464
0619	..	423	0815		420	0949		464
0620	..	396	0817		416	0950		464
0621 R	..	413	0821		419	0951		464
0622	..	413	0823		419	0952		464
0623	..	396	0824		419	0953		464
0624 R	..	F/C	0825		419	0954		464
0625	..	F/C	0826		408	0955/G		464
0626		421	0827		408	0955/M		464
0627	..	396	0828		419	0955/P		
0628	..	398	0829		419	0955/S		464
0629	..	396	0830		419	0956/G		464
0655		420	0831		419	0956/M		464
066106A		425	0832 R		408	0956/P		464
066108A		425	0833		408	0956/S		464
066110A		425	0834		405	0957/G		464
066112A		425	0835		405	0957/M		464
066206A		425	0836		405	0957/P		464
066208A		425	0837		405	0957/S		464
066210A		425	0839		412	0958/G		464
066212A		425	0842		419	0958/M		464
0667		420	0847		419	0958/P		464
0668		420	0848		419	0958/S		464
0669		420	0849		419	0959/G		464
0679		420	0852		414	0959/M		464
0680		420	0858		396	0959/P		464
0684		405	0859		419	0959/S		464
0685		405	0860		419	0960/G		464
0691		420	0861		419	0960/M		464

Codice Articolo	Euro	Pag List	Codice Articolo	Euro	Pag List	Codice Articolo	Euro	Pag List
0960/P	▪	464	1000/3	▪	CS70	1051		7
0960/S	▪	464	1000/4	▪	CS70	1052		25
0961/G	▪	464	1001		CG22	1053		134
0961/M	▪	464	1002		CG22	1054		25
0961/P	▪	464	1003		CG22	1066		220
0961/S	▪	464	1004		CG22	106601		221
0962/G	▪	464	1005		CG22	106602		221
0962/M	▪	464	1006		6	106603		220
0962/P	▪	464	1007		6	106604		220
0962/S	▪	464	1008		6	106605		220
0963/G	▪	464	1009		6	106606		220
0963/M	▪	464	1010		6	1067		25
0963/P	▪	464	101101	•	98	1068		23
0963/S	▪	464	101101H	•	378	1069		23
0964/G	▪	464	101101J	•	290	1070		23
0964/M	▪	464	101101K	•	249	1071		23
0964/P	▪	464	101101L	•	266	1072		23
0964/S	▪	464	101102	•	98	1073		23
0965/G	▪	464	101104	•	98	-1074	▪▪	23
0965/M	▪	464	101104H	•	378	1075		23
0965/P	▪	464	101104J	•	290	1076		23
0966/G	▪	464	101104K	•	249	1077		23
0966/M	▪	464	101104L	•	266	1078		23
0966/P	▪	464	101105	•	98	1079		23
0967/G	▪	464	101105H	•	378	1081		26
0967/M	▪	464	101105J	•	290	1082		26
0967/P	▪	464	101105K	•	249	1083		26
0968	▪	464	101105L	•	266	1084		26
0969	▪	465	101106	•	98	1085		26
0969G	▪	465	101108	•	98	1086	•	CG22
0970	▪	465	101109	•	98	1087	•	CG22
0970G	▪	465	101114	•	F/C	-1088 R	▪▪	48
0971	▪	465	101119	•	F/C	1089		48
0972	▪	465	1016		6	1090	•	CG22
0973	▪	465	1017		6	1091		7
0974	▪	465	1018		6	1092		7
0975	▪	465	1019		6	1093 R	▪▪	49
0976	▪	465	1020		6	1096		25
0977	▪	465	1021	•	CG22	1097		7
0978	▪	465	1022	•	CG22	1098		7
0979	▪	465	1023	•	CG22	-1099	▪▪	27
0980	▪	465	1024	•	CG22	-1100	▪▪	27
0981	▪	465	1025	•	CG22	-1101	▪▪	27
0982	▪	465	1026	•	CG22	-1102	▪▪	27
0983	▪	465	1027	•	CG22	1105		25
0984	▪	465	-1028		7	1106		25
0985	▪	465	1029		11	1107		25
0986	▪	464	1030		11	1108		25
0987	▪	464	1031		11	1109		22
0988	▪	464	1032		7	1110		22
0989	▪	464	1033		7	1113		22
099001	▪▪	390	1034		7	1114		25
0991	▪	CS70	1035		7	1116		22
0994	▪	464	1036		7	1117		22
0995	▪	464	1037		7	1119		25
0996	▪	465	1038		7	1120		25
0998	▪	CS70	1039		7	1122		25
0998/R	▪	CS70	1040		7	1123		25
0998/1	▪	CS70	1041		7	1126G		CG22
0998/2	▪	CS70	1042		7	1127G		CG22
0998/3	▪	461	1043		26	1128		25
0998/4	▪	461	1044		26	1129		25
0999	▪	CS70	1045		26	1131		25
1000	▪	CS70	1047		7	1132		25
1000/1	▪	CS70	1048		7	1134/D		161
1000/2	▪	CS70	1050		7	1134/S		161

Codice Articolo	Euro	Pag List	Codice Articolo	Euro	Pag List	Codice Articolo	Euro	Pag List
113407/D		161	1167		31	1236 P		71
113407/S		161	1168		31	1236 R		F/S
113410/D		161	1169		31	- 1237	--	128
113410/S		161	1170		31	1239		31
1135		34	1171		31	1239B		525
1135U		CG22	1172		31	1239H		382
113508		34	1173		31	1239J		282
113508W		316	1174		31	1239K		241
1136		34	1175		7	1239L		262
1136U		37	1176		CG22	1239W		316
113608		34	1177		CG22	- 1242	--	124
113608U		37	1178		CG22	1244		31
113608W		316	1178G		CG22	1245		32
1137		31	1179G		CG22	- 1246	--	152
1138		31	- 1184	--	222	124611	--	152
1139		31	1187		222	1247		95
1140		31	1188		137	1254		31
1141		31	- 1189	--	152	1255		7
1142		31	- 1190	--	26	- 1256	--	162
1143		31	- 1190P	--	26	1257		31
1145		31	- 1191	--	26	1258		29
1146		31	- 1191P	--	26	- 1259	--	132
1146B		525	- 1192	--	26	1260		72
1146H		382	- 1192P	--	26	1262		72
1146J		282	- 1196	--	152	1264 P		72
1146K		241	1197		152	1264 R		F/S
1146L		262	1198		31	1265		95
1146W		316	1201		34	1266		95
1147		31	1201U		37	- 1267	--	129
1148		31	120108		34	1269		25
1148B		525	120108U		37	1273		F/C
1148H		382	120108W		316	1274		95
1148J		282	1202		34	1276 P		72
1148K		241	1202U		37	1276 R		F/S
1148L		262	120208		34	1277 P		72
1148W		316	120208U		37	1277 R		F/S
1149		31	120208W		316	1278		95
1149B		525	1203		85	127800A		95
1149H		382	1206		32	1279		31
1149J		282	1207		94	1281		31
1149K		241	1208		5	1282		95
1149L		262	1209		5	1284		CG22
1149W		316	1210		5	1285		CG22
1150		31	1211		5	1286		CG22
1151		7	1212		156	1287		CG22
1152		7	1213		5	1288		F/S
1153		7	1214		85	128808		32
1154		7	1220		31	1289		36
1155		7	1223		94	1290		36
1156		25	1224		94	- 1291 R	--	112
1157		25	1227		94	1293G		CG22
1158		31	1228		94	1301 P		85
1159		31	1229		31	1301 R		F/S
1159B		525	1229U		37	1302		36
1159H		382	1230		34	1303G		CG22
1159J		282	123008		34	1304 P		85
1159K		241	1231		34	1304 R		F/S
1159L		262	123108		34	1305 R		CG22
1159W		316	1232		34	1306 R		93
1160		31	123208		34	1307 R		93
1161		22	123315		F/C	1308		29
1162		31	123320		F/C	1309		29
1163		31	1234 P		78	1310		95
1164		31	1234 R			1311 R		93
1165		31	1235 P		78	1312 P		93
1166		31	1235 R			1312 R		93

Codice Articolo	Euro	Pag List	Codice Articolo	Euro	Pag List	Codice Articolo	Euro	Pag List
1313 R		93	1381K		243	1442W		317
1314 R		93	1381L		264	1443		CG22
1315 P		93	1381NL		362	1443G		CG22
1315 R		93	1381U		29	14462		98
1317		32	1381W		315	14462/E	*	96
1318		32	1381Y		354	1448		24
1320 P		94	138107		24	1449		24
1320 R		93	138107J		284	1449/H		27
1321 P		94	138107K		243	1449J		283
1321 R		93	138107L		264	1449K		242
1322 P		94	138107NL		362	1449L		263
1322 R		93	138107W		315	1450		24
1323 P		94	138107Y		354	1450J		283
1323 R		93	1382		24	1450K		242
1327 R		85	1382J		284	1450L		263
1329		29	1382K		243	1451		24
1331		85	1382L		264	1451J		283
1334		154	1382NL		362	1451K		242
1338 R		85	1382U		29	1451L		263
1340		F/C	1382W		315	1452		24
1343/D		153	1398		154	1452J		283
1343/S		153	1400		154	1452K		242
1346 R		106	1401		137	1452L		263
1346UR		CG22	1401H		381	1453		24
1347		25	1401J		294	1455		123
1348		25	1401K		253	1455G		CG22
1348G		CG22	1401L		274	1457		33
1349		25	1402		137	145708		33
1349G		CG22	1403 R		93	1459 R	**	46
1352		95	1405 R		93	1462		20
1354		95	1411 R	**	46	- 1463	**	107
1355		95	1412 P		68	- 1464	**	107
1366		36	1412 R		F/S	1465		31
1367		36	1412HALF P2		68	1467		CG22
1368		36	1417		31	1468		121
1369		31	1420		131	1470		87
1369U		37	1421		131	1471		87
1370		31	1422		131	- 1473	**	166
1370U		37	1423		86	1474	**	CG22
1371		CG22	1426		22	1476		70
- 1374	**	152	1427		22	1478		34
- 137430	**	152	1428		22	1478G		CG22
1375		36	1430UR		CG22	147808		34
1376		137	1432		94	1479 P		86
1376CG		143	1437 P		82	1480		86
1376CR		143	1437 R		82	1481 R		86
1376CW		143	1438		82	1482		86
1376H		381	1439		106	1484		22
1377		24	1439J		286	- 1485	**	22
1377J		284	1439K		245	1486		156
1377K		243	1439L		266	1487		86
1377L		264	1439W		317	1488		122
1377NL		362	1440		106	1491		136
1377U		29	1440J		286	1492		16
1377W		315	1440K		245	1492J		283
1378		24	1440L		266	1492K		242
1378J		284	1440W		317	1492L		263
1378K		243	1441		106	1492W		314
1378L		264	1441J		286	1493		29
1378NL		362	1441K		245	- 1495	**	138
1378W		315	1441L		266	1497 P		111
1378Y		354	1441W		317	1499		CG22
1379UR		CG22	1442		106	1499U		CG22
1380		CG22	1442J		286	1500		95
1381		24	1442K		245	- 1502	**	108
1381J		284	1442L		266	1503U		CG22

Codice Articolo	Euro	Pag List	Codice Articolo	Euro	Pag List	Codice Articolo	Euro	Pag List
1504		95	1537KU		250	1620		107
1505 P		105	1537L		272	1624		107
1507		95	1537LU		271	1625		34
1511		24	1537U		84	162508		34
1516		86	1538		134	1626		107
1518		86	1539		134	1627		107
1519		17	1540		134	1628		34
1519J		283	1540H		381	162808		34
1519K		242	- 1541 P	..	86	1629		107
1519L		263	- 1541 R	..	F/S	- 1630	..	155
1519W		314	1542 P		106	- 1631	..	163
151901		18	1542JP		292	- 1632	..	163
151902		18	1542KP		251	- 1633	..	163
151903		18	1542LP		272	1636		107
151904		18	1547		30	1637		107
151905		18	1548 R		93	1640		123
151906		18	1549 P		CG22	1647		123
1520		17	1549 R		93	1647J		294
1520J		283	1550 R		93	1647K		253
1520K		242	1551 R		93	1647L		274
1520L		263	1553 R		93	1648		137
1520W		314	1564 P		87	1649		137
152001		18	1564 R		F/S	1649H		381
152002		18	1566		24	1651		135
152003		18	1566NL		362	- 1652	..	30
152004		18	1567		24	1653		32
152005		18	1567NL		362	1654		30
1521 R		86	- 1574	..	109	1655		30
1522		32	- 1576 P	..	107	1656		30
1523		17	1579		94	1657		30
1523J		283	1582		109	1658		20
1523K		242	1582J		292	1659		32
1523L		263	1582K		251	1660		F/C
1523W		314	1582L		272	1663		24
152301		18	- 1583	..	109	1663NL		362
152302		18	1584		F/C	1664		24
152303		18	- 1587 P	..	86	1664NL		362
152304		18	- 1587 R	..	F/S	- 1667	..	107
152305		18	1589		110	1668		101
1524		17	1590		110	1669 P		101
1524J		283	1591		98	1669 R		F/S
1524K		242	1591C		98	1673		36
1524L		263	1596		22	1674		32
1524W		314	1597		CS12	1675		30
152401		19	- 1599	..	108	1676		36
152402		19	1600		109	- 1677	..	163
152403		19	1601		109	1682		109
152404		19	1602		135	1682U		251
152405		19	1604		109	1683		30
1525 P		86	1605		109	1683W		316
1525 R		86	1608		109	1684		30
1528		17	1611		109	1684W		316
1528J		283	1612		109	1685		134
1528K		242	1614		123	1686		134
1528L		263	1614J		294	1687		134
1528W		314	1614K		253	1688		134
152801		19	1614L		274	1689		134
152802		19	1614N		123	1690		134
152803		19	1614NL		366	1693 P		70
- 1530 R	..	86	1614W		325	1693 R		70
- 1533	..	86	1614Y		354	1694		70
- 1536	..	17	1616		101	1696		21
1537		83	1617 P		101	169608		21
1537J		292	1617 R		F/S	1697		70
1537JU		291	1618		107	1698 P		70
1537K		251	- 1619	..	163	1698 R		70

Codice Articolo	Euro	Pag List	Codice Articolo	Euro	Pag List	Codice Articolo	Euro	Pag List
-1700	..	134	1764U		122	1838L		273
-1701	..	134	1764W		325	1838W		324
1704		CG22	1765		122	-1842	..	166
1705		CG22	1766		32	-1843	..	90
1706		30	1767		122	-1844	..	166
-1707 R	..	112	1768		122	1846		81
1708		CG22	1769		122	1847 P		81
1709		CG22	1770		122	1847 R		81
1712	..	108	1772 R			-1848	..	86
1713		163	1773 P		82	-1849	..	90
1713W		323	1774		124	1850 R		86
1715		70	1775		124	1851		86
1717		CG22	1776 P		81	1852/D		138
1718		CG22	1777		CG22	1852/S		138
1719		CG22	-1779	..	86	-1853	..	90
1736		106	1780		34	1854 P		86
1738		122	178008		34	1854 R		F/S
-1739	..	130	-1781	..	86	1855		82
1743		98	1783		124	1856		123
1743/E	.	96	1784		124	1857		134
1743G		F/S	1785		80	1861		86
1743MA		F/C	1786		134	-1862	..	90
17432		98	1789		134	1863		123
17432/E	.	96	1790		134	1864		23
17432MA		F/C	1791		134	1866		30
1744 P		80	1792		122	-1867	..	155
1744 R		80	1793		122	1869 P		86
1746		F/S	1795 P		86	1869 R		F/S
174608		32	1795 R		F/S	1870		86
1747		CG22	1796		86	-1871	..	130
1748 R		CG22	-1797	..	155	-1872	..	130
1754		70	1801		78	-1873 R	..	54
1756		135	1804		134	1876		72
1759 R		CG22	1806		124	1877		109
1760		122	1806W		325	1881		137
1760J		294	1807		124	1881CG		143
1760K		253	1807W		325	1881CR		143
1760L		274	1808		124	1881CW		143
1760W		325	-1811	..	154	1881J		294
1761		122	1812 P		78	1881K		253
1761H		381	1812 R		78	1881L		274
1761J		294	-1813	..	108	1881W		325
1761K		253	1814		22	-1887 R	..	90
1761L		274	1815		22	1889		124
1761W		325	1816		22	1890		82
1762		122	-1817	..	22	1890/E	.	96
1762H		381	1818		156	-1892	..	163
1762J		294	1820		156	1893 P		86
1762K		253	1821		82	1893 R		F/S
1762L		274	1822 P		82	1895		95
1762NL		366	1822 R		82	-1896	..	90
1762W		325	-1823	..	90	1897 P		106
1763		122	1824 P		86	1897GP		F/S
1763H		381	-1825	..	90	1897JP		292
1763J		294	1827		157	1897JPU		291
1763K		253	1827W		323	1897KP		251
1763L		274	1832		81	1897KPU		250
1763NL		366	1833		157	1897LP		272
1763U		122	1833W		323	1897LPU		271
1763W		325	1834		153	1897UP		106
1764		122	1835		153	-1898	..	90
1764H		381	1837		153	1899		81
1764J		294	1837W		324	1900 P		81
1764K		253	1838		153	1900 R		81
1764L		274	1838J		293	-1906 R	..	54
1764NL		366	1838K		252	1907		154

Codice Articolo	Euro	Pag List	Codice Articolo	Euro	Pag List	Codice Articolo	Euro	Pag List
1907J		293	1988		153	2076		24
1907K		252	1990		153	2076J		284
1907L		273	- 1992	..	25	2076K		243
1907W		323	- 1996	..	25	2076L		264
- 1908	..	166	- 1997 P	..	54	2076NL		362
1910		134	1998		149	2076U		29
1910H		381	1999		149	2076V3		335
1911		134	2000 P		83	2076V4		335
1911H		381	2000 R		83	2076W		315
- 1913	..	166	2000JPU		291	2076Y		354
1914 R	..	40	2000JRU		291	2077		24
1919 P		70	2000KPU		250	2077J		284
1919 R		70	2000KRU		250	2077K		243
1920 R	..	40	2000LPU		271	2077L		264
1923	..	40	2000LRU		271	2077NL		362
1924	..	158	2000UP		84	2077U		29
1925	..	40	2000UR		84	2077V3		335
1934		110	2002		148	2077V4		335
1935		110	2003		149	2077W		315
1936		110	2005		149	2077Y		354
1937		110	2030		34	2078		24
1938		23	2031		34	2078J		284
1939		72	- 2032	..	26	2078K		243
1940		86	- 2032P	..	26	2078L		264
1941		24	- 2033	..	26	2078NL		362
1941NL		362	- 2033P	..	26	2078W		315
1942 P		70	- 2034	..	26	2078Y		354
1942 R		70	- 2034P	..	26	- 2079		7
1945		24	- 2035	..	26	- 2080		7
1945NL		362	- 2035P	..	26	- 2081		7
1947		23	- 2036	..	26	- 2083		7
1948		23	- 2036P	..	26	2087		23
1954		24	- 2037	..	26	2088		23
1954NL		362	- 2037P	..	26	2089		23
1956/D		138	2047	.	9	2090		23
1956/S		138	2051	.	9	2091		23
- 1957	..	134	2054	.	9	2092		23
1959	..	40	2057	.	9	2094		24
1961		137	2057B	.	521	2094J		284
1961CG		143	2057J	.	281	2094K		243
1961CR		143	2057K	.	240	2094L		264
1961CW		143	2057L	.	261	2094NL		362
1962		138	2057W	.	313	2094U		29
1962CG		144	2060 R		86	2094W		315
1962CR		144	2061		86	2095		24
1962CW		144	2062		29	2095J		284
1963		138	2063		26	2095K		243
1964/D		138	2065	.	9	2095L		264
1964/S		138	2066	.	9	2095NL		362
1965		138	2067	.	9	2095W		315
1965CG		144	2068	.	9	2097		153
1965CR		144	2069	.	9	2098		153
1965CW		144	2070	.	9	2098/S		153
- 1966 R	..	111	2071	.	9	2098/SW		323
- 1967 R	..	111	2072	.	9	2100		99
1973		81	2073	.	9	2101 R		83
1974 P		81	2074/D		161	2101UR		84
1974 R		81	2074/S		161	2103 R		83
1979		70	2075		24	2103JRU		291
1983		21	2075J		284	2103KRU		250
1983G		CG22	2075K		243	2103LRU		271
1984 P		F/S	2075L		264	2103UR		84
1984 R		70	2075NL		362	2105 R		112
1986/D		55	2075U		29	2105JRU		291
1986/S		55	2075W		315	2105KRU		250
- 1987 R	..	55	2075Y		354	2105LRU		271

Codice Articolo	Euro	Pag List	Codice Articolo	Euro	Pag List	Codice Articolo	Euro	Pag List
2105UR		84	2194		101	2268W		319
2106		83	2195 P		101	2268Y		354
2106JU		291	2196		88	2270		82
2106KU		250	2197		88	2276 R	..	43
2106LU		271	- 2203 P	..	91	2277	..	43
2106U		84	- 2203 R	..	91	2278	..	43
2107		109	- 2205	..	91	2279	..	43
2107JU		292	- 2206	..	91	2281	..	45
2107KU		251	- 2207 R	..	91	2283 R		82
2107LU		272	- 2208 P	..	91	2284		110
2107U		109	- 2208 R	..	91	- 2285	..	110
2111		121	2209		26	- 2286	..	110
2112		121	2210		26	2288		106
2113		121	- 2211	..	91	2288/E	.	96
2115 P		83	2213 P		87	2289		110
2115 R		83	2214	..	451	2299	..	45
2115JRU		291	2216		121	- 2300	..	166
2115KRU		250	2216J		294	2303		106
2115LRU		271	2216K		253	2303U		106
2115UP		84	2216L		274	2304/D		153
2115UR		84	2216W		325	2304/S		153
2116			2217	..	451	2306		31
2117			2219	..	451	2307		31
2118		F/S	2219E	..	451	2308		31
2119		F/S	2221	..	45	2309		31
2127		125	2222		121	2315		30
2127W		325	2222J		294	2316		121
2128		125	2222K		253	2317		121
2128W		325	2222L		274	2324		22
2129		125	2222W		325	2325		95
2133		101	2223	..	451	2326		95
2134 P		101	2225		150	2327		CG22
2136 P		68	2226		150	2337		25
2136 R		68	2227		29	2339 R		72
2137		68	2228		29	2340		122
2138 P		68	2229		99	2341		122
2138 R		68	2231		154	2342		122
2139		68	2231J		293	2343		122
- 2142	..	26	2231K		252	2345 P	..	46
- 2142P	..	26	2231L		273	2346		156
- 2143	..	26	2231W		324	2347		154
- 2143P	..	26	- 2232	..	125	2348		157
- 2144	..	26	2233 P		CG31	2349		29
- 2144P	..	26	2234 R		111	2350		30
2145		152	2235	..	43	- 2351 P	..	50
2148		102	2237		24	2352		50
2148W		319	2239 P		72	2354		135
2148Y		354	2239 R		F/S	2354J		294
2149 P		102	2240 P		72	2354K		253
2149WP		319	2240 R		F/S	2354L		274
2149YP		354	2241 P		112	2355		25
- 2155	..	91	2242 P		F/S	2356		80
2159			2244 P		82	2357		71
2160			2244 R		82	2358		71
2161		F/S	2245		109	2366		30
2162		F/S	- 2246	..	168	2367		87
2171		123	- 2247	..	168	2367/E	.	96
2172		123	- 2248	..	168	2367VL	.	CG22
- 2173	..	91	- 2249	..	168	2368 P		87
2174		129	2250 R	..	45	2372		124
2175		129	2251		154	2373		136
2179		72	2255		26	2375/D		137
2180		72	2256		26	2375/S		137
2190 P		82	2263/D	..	38	2377		24
2191 P		81	2263/S	..	38	2379		137
2193		151	2268		102	2380		138

Codice Articolo	Euro	Pag List	Codice Articolo	Euro	Pag List	Codice Articolo	Euro	Pag List
2380CG		143	2471		136	2545 R		71
2380CR		143	2472		136	2546		71
2380CW		143	2473		135	2547 P		71
2381		137	2475		24	2547 R		71
2381CG		144	2476		24	2548		71
2381CR		144	2477		24	2549 P		78
2381CW		144	2478		24	2549 R		F/S
2382		122	-2481 P	..	50	2550		78
2383		26	2482		50	2551 P		78
2386		24	-2484 P	..	54	2551 R		F/S
2387 R		68	2485		154	2552		78
2388 R		68	-2486	..	132	2553 P		78
2389		24	-2487	..	129	2553 R		F/S
2390		4	2490 P		F/S	2554		78
2391		4	2490 R		CG22	2555		78
2392		4	2491		68	2556		153
2393		4	2492		68	2558		153
2394		4	-2495	..	128	2568		87
2395		4	-2496	..	124	2571 P		71
2396		4	2497/D		150	2571 R		71
2397		4	2497/S		150	2572		5
-2398	..	165	249705/D		150	2573		5
-2399	..	163	249705/S		150	2574		5
2404		24	249710/D		150	2575		5
2405		24	249710/S		150	2576		5
2408		24	2498 P		68	2577		5
2409		24	2498 R		F/S	2578		5
2410			2499 P		68	2579		5
2412		154	2499 R		F/S	2580		5
2412J		293	2500 P		68	2581/D		136
2412K		252	2500 R		CG22	2581/DW		325
2412L		273	2503		135	2581/S		136
2412W		323	2505 R		CG22	2581/SW		325
2413		127	2506		24	2583		135
2414		127	2507		24	2584		135
2415		127	-2509	..	130	2585		97
2416		127	-2510/D	..	52	2585/E	.	96
2418		154	-2510/S	..	52	2585NL		365
2419 R		71	-2511	..	53	2585U		CG22
-2422	..	17	-2512	..	130	2585VL	.	CG22
-2423	..	17	2513 P		71	2585Y		354
-2424	..	17	2514		68	-2586 R	..	47
-2425	..	17	2515		68	-2588 R	..	112
2426		26	2516		24	-2589 R	..	112
2431		34	2519		24	-2590 R	..	47
2432		34	2520		20	-2591	..	47
2434		135	2521		165	-2592	..	47
2435 P		105	2522		165	-2593	..	47
2441		127	2523		122	2594 P		71
2442		127	2524		122	2594 R		F/S
2444		122	2525	..	41	2595		71
2445		122	-2526 R	..	53	2599		78
-2453	..	27	-2527	..	27	2600		154
-2454	..	27	2528/D	..	41	2601 P		100
2455	.	9	2528/S	..	41	2604		121
2455B	.	521	2529 R	..	41	2606		106
2455J	.	281	2531		34	2606/E	.	96
2455K	.	240	253108		34	2607 P		106
2455L	.	261	2532		137	2608		121
2455W	.	313	2533		24	2609		121
2462		161	2534		71	2610		121
2463		34	2535		24	2611 P		100
246308		34	-2536	..	128	2611 R		F/S
2466		36	2537		125	2612 P		78
2467		36	2544		150	2612 R		F/S
2470		136	2545 P		71	2613	..	45

Codice Articolo	Euro	Pag List	Codice Articolo	Euro	Pag List	Codice Articolo	Euro	Pag List
2614 R	**	45	2669		137	27E3JRU		289
2615	**	45	2670 P		101	27E3KRU		248
2616	**	45	2670 R		101	27E3LRU		270
- 2617	**	154	2671		101	27E3JUR		CG22
2618 P		78	2672 P		101	27E3WRU		321
2618 R		F/S	2672 R		F/S	27E4JU		289
2619 R	**	44	2673		101	27E4KU		248
- 2620 R	**	55	2674		164	27E4LU		270
2626 R		106	2675		156	27E4U		CG22
2627 P		71	2675W		323	27E4WU		321
2628		71	2676		156	27E7	**	20
2630		157	2676W		323	27E8	**	
2630J		293	2677		17	27F1		13
2630K		252	2678		121	27F2		13
2630L		273	2679		121	27F3		13
2631		80	2680		156	27F4		13
2632		20	2680W		323	27F5		13
2633		20	2681		82	27F8	**	49
2635 R	**	44	2685		81	- 27F9	**	48
2636		134	2686		81	2700	**	41
2637 P		F/S	2687 P		81	2701		81
2637 R		F/S	2687 R		F/S	2702		81
2638 P		101	2688		25	2703 P		81
2638 R		F/S	2689		25	2703 R		F/S
2638NLP		363	2690 P		80	2706 P		68
2638WP		322	2690 R		80	2706 R		F/S
2638YP		353	2691		80	2707		68
2640 P		F/S	2693		17	2710 P		CG22
2640 R		F/S	2693J		283	2710 R		F/S
2641		101	2693K		242	2711		CG22
2641NL		363	2693L		263	2713 P		80
2641W		322	2693W		314	2713 R		80
2641Y		353	2694	**	108	2714		80
2642		157	2695 P		78	2715		25
2642J		293	2695 R		F/S	2716		25
2642K		252	2696		78	2717		105
2642L		273	2697 P		101	- 2720/D	**	51
2642NL		366	2697 R		F/S	- 2720/S	**	51
2643		34	2697NLP		363	- 2721 P	**	54
264308		34	2697WP		322	2723	*	9
2647	**	108	2697YP		353	2723B	*	521
2647G		CG22	2698		101	2723J	*	281
2649		136	2698NL		363	2723K	*	240
2649NL		366	2698W		322	2723L	*	261
2651		135	2698Y		353	2723W	*	313
2655		34	2699	**	41	2724	*	9
265508		34	27A001	**	17	2724AB	*	521
2656		28	27A002		17	2724J	*	281
- 2657 R	**	54	27A003		17	2724K	*	240
2658		32	27A004		17	2724L	*	261
2660 R		71	27A005		17	2724W	*	313
2661		97	27A3		121	2725		16
2661/E	*	96	27A4		121	2727		20
2661C		97	27C1		129	2732		21
2661NL		365	27E1JRU		289	2732G		CG22
2661U		CG22	27E1KRU		248	2733		21
2661Y		354	27E1LRH		270	2735		154
2662		97	27E1LRU		270	2735H		381
2662/E	*	96	27E1UR		CG22	2735J		293
2662NL		365	27E1WRU		321	2735K		252
2662U		CG22	27E2JU		289	2735L		273
2662Y		354	27E2KU		248	2735W		323
2663		78	27E2LH		270	2736		154
2664		97	27E2LU		270	2736H		381
266400A			27E2U		CG22	2736J		293
2666		97	27E2WU		321	2736K		252

Codice Articolo	Euro	Pag List	Codice Articolo	Euro	Pag List	Codice Articolo	Euro	Pag List
2736L		273	2806		CG22	2890 P		80
2736NL		366	- 2814/D	..	28	2890 R		80
2736W		323	- 2814/S	..	28	2891 P		80
2736Y		354	2820		105	2891 R		80
2737		154	2827 P		88	2892 P		80
2738		148	2828		88	2892 R		F/S
2739		30	2830		154	2893 P		80
2740		137	2830J		293	2893 R		F/S
2740H		381	2830K		252	2894		80
2743		154	2830L		273	2895		80
2743H		381	2830NL		366	2896		80
2743J		293	2830Y		354	2897		80
2743K		252	2831		21	2898		80
2743L		273	2832		21	29A0		13
2743W		323	2835		21	29A1		13
2744		83	2835G		CG22	29A2		13
2744/E	*	96	2836		21	29A3		13
2744J		292	2836G		CG22	29A6		13
2744JU		291	2841 P		106	29Y9		67
2744K		251	2842 R		CG22	29Y9J		288
2744KU		250	2842GR		CG22	29Y9JU		289
2744L		272	2843 R		CG22	29Y9K		247
2744LU		271	2843GR		CG22	29Y9KU		248
2744U		84	2844GR		CG22	29Y9L		268
2744W		322	2845GR		CG22	29Y9LU		269
- 2747 R	..	112	2848 P		F/S	29Y9NLU		364
2751		CG22	2848 R		CG22	29Y9U		65
2753 P		86	2848GR		CG22	2900	*	14
2753 R		F/S	2849 P		F/S	2901	*	14
2755		148	2849 R		CG22	2902	*	14
2756		150	2864UR		CG22	2903	*	14
- 2757	..	132	2867UR		CG22	2904	*	14
- 2758	..	129	2868UR		CG22	2905		17
- 2759	..	128	2870U		CG22	2905J		283
- 2760	..	124	287101		F/C	2905K		242
2761 P		F/S	287102		F/C	2905L		263
2761 R		CG22	287103		F/C	2905W		314
2763		CG22	287104		F/C	2907		67
2763G		CG22	287105		F/C	2908		35
2764 P		F/S	287204		F/C	2908B		525
2764 R		CG22	287301		F/C	2908H		382
2764GR		CG22	287302		F/C	2908J		282
2765		CG22	287303		F/C	2908K		241
2766		CG22	287304		F/C	2908L		262
2766G		CG22	2874	*	9	2908U		37
2768 R		CG22	2875	*	9	2908W		316
2768GR		CG22	2876	*	9	2909		17
2769		CG22	2877	*	9	2909J		283
2769G		CG22	2877B	*	521	2909K		242
2770		CG22	2877J	*	281	2909L		263
2770G		CG22	2877K	*	240	2909W		314
2771		CG22	2877L	*	261	2910		35
2771G		CG22	2877W	*	313	2910B		525
2772		CG22	2880	*	15	2910H		382
2777		CG22	2881	*	15	2910J		282
2778		CG22	2882	*	15	2910K		241
2793		CG22	2883	*	15	2910L		262
2793G		CG22	2884	*	15	2910U		37
2795		CG22	2886	*	15	2910W		316
2795G		CG22	2887	*	15	2911		35
2797		CG22	2888	*	9	2911B		525
2798		CG22	2888B	*	521	2911H		382
2798G		CG22	2888J	*	281	2911J		282
28A001		17	2888K	*	240	2911K		241
28A002		17	2888L	*	261	2911L		262
2804		25	2888W	*	313	2911U		37

Codice Articolo	Euro	Pag List	Codice Articolo	Euro	Pag List	Codice Articolo	Euro	Pag List
2911W		316	2939NLU		362	2956K		243
2914		35	2939U		23	2956KU		243
2914J		282	2940 P		101	2956L		264
2914K		241	2941 P		101	2956LU		264
2914L		262	2941 R		F/S	2956NLU		362
2914W		316	2942		123	2956W		315
2915		35	2942J		294	2956WU		315
2915J		282	2942K		253	2958 P		67
2915K		241	2942L		274	2958 R		F/C
2915L		262	2942NLU		366	2958JP		288
2915W		316	2942U		123	2958JPU		289
2918		31	294201U		123	2958JR		288
2919	.	14	2943		121	2958JRU		289
2920	.	14	2944		32	2958KP		247
2921	.	14	294412		32	2958KPU		248
2922	.	14	2945		23	2958KR		247
2923	.	14	2945JU		284	2958KRU		248
2924	.	14	2945KU		243	2958LP		268
2925		70	2945LU		264	2958LPU		269
2925NLU		365	2945NLU		362	2958LR		268
2925U		69	2945W		315	2958LRU		269
2926		70	294508		23	2958NLPU		364
2926NLU		365	294508NLU		362	2958UR		65
2926U		69	2946		23	2959		23
2927 R		70	2946JU		284	2959J		284
2927NLPU		365	2946KU		243	2959JU		284
2927UR		69	2946LU		264	2959K		243
2928 P		70	2946NLU		362	2959KU		243
2928 R		70	2946W		315	2959L		264
2928NLPU		365	2947U		CG22	2959LU		264
2928UR		69	2948		23	2959NLU		362
2929		70	2948JU		284	2959W		315
2929NLU		365	2948KU		243	2959WU		315
2929U		69	2948LU		264	2960		23
2930		70	2948NLU		362	2960J		284
2931		70	2948W		315	2960JU		284
2931NLU		365	2949		23	2960K		243
2931U		69	2949JU		284	2960KU		243
2932 P		70	2949KU		243	2960L		264
2932 R		70	2949LU		264	2960LU		264
2932NLPU		365	2949NLU		362	2960NLU		362
2932UR		69	2949W		315	2960W		315
2933		70	294907		23	2960WU		315
2933NLU		365	294907NLU		362	2964		145
2933U		69	2950		157	2965		11
2934 P		70	2950W		323	2966		11
2934 R		F/S	2951		29	2969 P		67
2934NLPU		365	2951X		29	2969 R		67
2934UR		69	2952		29	2969JP		288
2935 P		70	2952X		29	2969JPU		289
2935 R		F/S	2953U		CG22	2969JR		288
2935NLPU		365	295401		F/C	2969JRU		289
2935UR		69	295402		F/C	2969KP		247
2936 P		70	2955		23	2969KPU		248
2936 R		F/S	2955J		284	2969KR		247
2936NLPU		365	2955JU		284	2969KRU		248
2936UR		69	2955K		243	2969LP		268
2937 P		70	2955KU		243	2969LPU		269
2937 R		F/S	2955L		264	2969LR		268
2937NLPU		365	2955LU		264	2969LRU		269
2937UR		69	2955NLU		362	2969NLPU		364
2938		23	2955W		315	2969UR		65
2938NLU		362	2955WU		315	2970J		288
2938U		23	2956		23	2970JU		289
293808		23	2956J		284	2970K		247
2939		23	2956JU		284	2970KU		248

Codice Articolo	Euro	Pag List	Codice Articolo	Euro	Pag List	Codice Articolo	Euro	Pag List
2970L		268	2982JP		288	2994 P		78
2970LU		269	2982JPU		289	2995 P		78
2970NLU		364	2982JR		288	2996JP		288
2970U		65	2982JRU		289	2996JPU		289
2971		67	2982KP		247	2996JR		288
2971/E		96	2982KPU		248	2996JRU		289
2971J		288	2982KR		247	2996KP		247
2971JU		289	2982KRU		248	2996KPU		248
2971K		247	2982LP		268	2996KR		247
2971KU		248	2982LPH		269	2996KRU		248
2971L		268	2982LPU		269	2996LP		268
2971LU		269	2982LR		268	2996LPU		269
2971NLU		364	2982LRH		269	2996LR		268
2971U		65	2982LRU		269	2996LRU		269
2971W		322	2982NLPU		364	2996UR		65
2971WU		321	2982UR		65	2997J		288
2972G	CG22		2983		67	2997JU		289
2972U	CG22		2983J		288	2997K		247
2973G	CG22		2983JU		289	2997KU		248
2973U	CG22		2983K		247	2997L		268
2974	24		2983KU		248	2997LU		269
2974J	283		2983L		268	2997U		65
2974K	242		2983LH		269	2998		67
2974L	263		2983LU		269	3000BZ	..	209
297407	24		2983NLU		364	3001	..	201
297407J	283		2983U		65	3002	..	180
297407K	242		2984		67	- 3003	..	130
297407L	263		2984/E		96	3004	..	199
2975 P	88		2984J		288	3005	..	188
297530 P	88		2984JU		289	3006	..	198
2976	16		2984K		247	3007	..	198
2976J	283		2984KU		248	3008	..	180
2976K	242		2984L		268	3011	..	179
2976L	263		2984LU		269	3012	..	211
2976W	314		2984NLU		364	301401	..	208
297601	16		2984U		65	301401M	..	208
297602	16		2984W		322	301401P	..	208
297603	16		2984WU		321	301402	..	209
297605	16		2985 P		67	301402M	..	209
297606	16		2985 R		F/C	301402P	..	209
2977	16		2985JP		288	3015	..	208
2977J	283		2985JPU		289	3016	..	221
2977K	242		2985JR		288	3019	..	180
2977L	263		2985JRU		289	3020	..	221
2977W	314		2985KP		247	3021	..	221
2978	16		2985KPU		248	- 3022	..	178
2978J	283		2985KR		247	3024	..	184
2978K	242		2985KRU		248	3026	..	185
2978L	263		2985LP		268	3027	..	186
2978W	314		2985LPU		269	3028	..	200
2979	16		2985LR		268	3029	..	205
2979J	283		2985LRU		269	3030	..	205
2979K	242		2985NLPU		364	303001	..	205
2979L	263		2985UR		65	3031	..	205
2979W	314		2986		95	3032	..	205
2980	24		2987		88	3033	..	185
2980J	283		2988		97	- 3034	..	181
2980K	242		2989		78	3035	..	195
2980L	263		2990 P		67	3036	..	189
2981	24		2991 P		72	3037	..	189
2981J	283		2992		23	3038	..	189
2981K	242		2992JU		284	3039	..	189
2981L	263		2992KU		243	3040	..	189
298111	24		2992LU		264	3042	..	194
2982 P	67		2992W		315	- 3043	..	194
2982 R	67		2993 P		78	3044	..	132

Codice Articolo	Euro	Pag List	Codice Articolo	Euro	Pag List	Codice Articolo	Euro	Pag List
3046	..	132	- 3151	..	166	- 3243	..	221
3047	..	195	- 3152	..	131	- 3244	..	221
304701	..	194	- 3153	..	131	- 3245	..	221
3048	..	182	- 3154	..	196	- 3246	..	220
3049	..	178	- 3155	..	164	- 3250	..	224
3050	..	216	- 3156	..	131	- 3251	..	197
- 3051	..	211	- 3158	..	155	- 3253	..	134
3052	..	216	- 3162	..	168	- 3254	..	158
- 3054	..	194	3166	..	200	- 3255	..	197
3055	..	188	3167	..	188	- 3256	..	158
3057	..	211	3168	..	183	3258	..	213
3059	..	211	- 3169	..	192	3259	..	221
- 3061	..	124	- 3170	..	192	- 3260	..	197
3063	..	190	3172	..	200	- 3262	..	197
3064	..	133	- 3173	..	194	3265	..	180
3065	..	133	- 3174	..	124	- 3266	..	178
3066	..	133	3175	..	202	- 3268	..	181
3066C	..	177	3176	..	222	- 3269	..	195
- 3067	..	133	- 3178	..	131	- 3270	..	219
3069	..	182	- 3179	..	196	- 3272	..	178
- 3071	..	128	3181	..	222	- 3273	..	189
- 3072	..	124	- 3182	..	164	3274	..	167
- 3077	..	165	- 3183	..	169	3275	..	213
3079	..	195	- 3184	..	169	- 3276	..	218
- 3081	..	164	- 3185	..	169	3277	..	167
3084	..	211	- 3186	..	169	3278	..	167
3087	..	201	- 3189	..	169	3279	..	167
3092	..	185	- 3190	..	169	- 3280	..	190
- 3093	..	194	- 3191	..	169	- 3281	..	186
3094	..	180	- 3192	..	164	- 3282	..	190
3096	..	200	- 3193	..	169	- 3283	..	186
3097	..	187	- 3194	..	169	- 3284	..	194
- 3098	..	224	- 3195	..	169	3285	..	199
3099	..	179	- 3196	..	178	- 3287	..	220
- 3100/D	..	162	3197	..	178	- 3288	..	194
- 3100/S	..	162	- 3198	..	178	- 328840	..	197
- 3101	..	155	3199	..	182	- 3290	..	195
- 3102	..	166	- 3202	..	187	- 3291	..	222
3103	..	212	3204	..	190	3293	..	187
- 3106	..	133	- 3205	..	178	- 3294	..	184
3107	..	134	- 3206	..	178	- 3295	..	182
- 3108	..	133	3207	..	178	- 3296	..	186
- 3109	..	155	- 3208	..	130	3298	..	181
3110	..	198	- 3209	..	129	3299	..	183
3111	..	198	3210	..	130	3300	..	168
3112	..	167	3211	..	180	3301	..	221
3113	..	167	- 3212	..	130	- 3302	..	218
3114	..	198	- 3213	..	129	- 3303	..	192
3115	..	183	- 3216	..	178	- 3304	..	196
- 3117	..	131	3219	..	187	- 3305	..	185
- 3118	..	224	3221	..	179	- 3306	..	197
- 3119	..	167	- 3222	..	224	3307	..	133
3122	..	187	3223	..	176	3308	..	181
3125	..	200	- 3225	..	155	3309	..	181
3129	..	182	- 3226	..	164	- 3311	..	186
- 3133	..	162	- 3227	..	165	- 3314	..	186
3136	..	200	3228	..	212	- 3315	..	187
3137	..	180	3230	..	112	3316	..	222
3139	..	203	- 3231	..	178	3317	..	204
313901	..	204	3233	..	195	- 3318	..	197
- 3144	..	192	- 3234	..	220	- 3319	..	192
- 3146	..	167	3235	..	192	3322	..	156
- 3147	..	169	3236	..	186	3323	..	211
- 3148	..	169	3240	..	204	3327	..	222
- 3149	..	169	- 3241	..	220	3328	..	222
- 3150	..	169	- 3242	..	220	3329	..	191

Codice Articolo	Euro	Pag List	Codice Articolo	Euro	Pag List	Codice Articolo	Euro	Pag List
-3330	..	195	-3415	..	164	-346802	..	219
3331	..	184	-3416	..	155	-346804	..	219
3332	..	201	-3417	..	166	-3469	..	219
3333	..	190	-3418	..	156	3470	..	161
-3334	..	192	3419	..	200	3473	..	204
-3335	..		3420	..	F/C	3475	..	201
3336	..	197	3421	..	210	3476	..	217
-3338	..	190	3422	..	210	3477	..	217
-3339	..	157	3423	..	176	3478	..	217
3340	..	191	3424	..	201	3479	..	204
3342	..	192	3425	..	211	3480	..	217
3343	..	210	3426	..	199	3481	..	188
3344	..	177	-3427	..	185	3482	..	198
-3346	..	184	-3428	..	184	3486	..	183
-3347	..	190	-3429	..	196	-3487	..	155
-3348	..	185	-3430	..	CS14	3488	..	217
-3350	..	CG22	-3431	..	CS14	3489	..	217
-3351	..	166	-3432	..	218	3490	..	217
-3352	..	166	3433	..	176	3490/S	..	217
3353	..	191	3434	..	F/S	349140	..	208
-3354	..	218	3435	..	194	349160	..	208
-3356	..	193	3436	..	134	3492	..	204
3357	..	205	3437	..	205	3493	..	202
3358	..	205	3438	..	39	3493P	..	202
3359	..	216	3442	..	190	3494	..	183
3359SA	..	196	3443	..	193	3495	..	222
-3360	..	200	3444	..	193	3496	..	202
3361	..	211	-3445	..	191	3497	..	197
3368	..	199	-3446	..	191	3498	..	197
-3370	..	184	3447	..	193	377508	..	17
-3371	..	193	-3448	..	216	388001	..	204
-3372	..	195	3449	..	191	388020	..	157
3373	..	210	3450	..	203	399024	..	213
3374	..	197	-3451	..	216	399025	..	213
3375	..	191	-3451SA	..	196	399026	..	213
3376	..	191	3452	..	F/C	399027	..	214
3377	..	133	3453/F	..	221	399028	..	213
3378	..	192	3453/FP	..	221	399028P	..	213
3379	..	158	3453/M	..	221	399029	..	162
3382	..	168	3453/MP	..	221	399030	..	133
3385	..	179	3454	..	210	399031	..	214
3386	..	216	3455	..	197	399032	..	203
-3387	..	211	3456	..	189	399033/D	..	215
3388	..	132	3457	..	194	399033/S	..	215
3389	..	216	345801	..	208	399034	..	206
3390	..	216	345801P	..	208	399035	..	206
3391	..	216	345802	..	208	399036	..	206
3393	..	CG22	345802P	..	208	399037	..	207
-3394	..	200	3459	..	128	399038	..	207
3395	..	193	345901	..	128	399039	..	207
3397	..	197	-346001	..	157	4000A	..	110
3398	..	197	-346002	..	157	4000B	..	110
3399	..	196	-3461	..	F/C	4000C	..	110
3400	..	156	3462/D	..	215	4000C1	..	110
3401	..	205	3462/S	..	215	4000D	..	F/S
3402	..	205	346301	..	219	4007I	..	88
3403	..	191	346302	..	219	4011	..	135
3405	..	197	346303	..	219	4019I	..	F/C
3406	..	134	346304	..	219	4020I	..	F/S
3407	..	185	346401	..	219	4031I	..	
3408	..	210	346403	..	219	4038	..	87
3409	..	193	346404	..	219	4049	..	150
3410	..	192	3465	..	162	4050	..	150
3411	..	219	-3466	..	169	4051IP	..	112
3412	..	219	3467	..	217	4056I	..	87
-3414	..	166	-346801	..	219	4070I	..	84

Codice Articolo	Euro	Pag List	Codice Articolo	Euro	Pag List	Codice Articolo	Euro	Pag List
4079IP		112	- 4284	..	160	4800		125
4085		110	- 4285	..	159	4801		133
4101I		87	- 4286	..	160	4802		127
4102I		87	- 4296	..	156	4803		148
4104I		87	429901		145	4804		151
4105I		87	429902		145	4805		151
4108IP		112	429903		145	4809		154
4111		126	429904		145	4812		154
4112		126	429905		145	4814		127
4112N		126	4335I		97	4815		127
4113		127	4421	..	184	4816		127
4117		125	4468I		97	4817		126
411730		125	4478		127	4818		126
4118		135	- 4492	..	159	4821		149
4121		87	4498		146	4822		149
4122I		97	4499		146	4824		151
4131		148	4500		152	4831		127
4132		148	4508I		84	483116		127
4133		136	4531I		97	483120		127
4146 P		101	4533		152	483125		127
415107		102	4534		152	483150		127
415208		102	4541		95	483160		127
4163I		87	4542		95	4841		127
416401		125	4543		151	4857		124
416402		125	4544		151	4858		154
416501		126	4546I		84	4858W		323
416502		126	4570		145	4859		135
416503		126	4584		146	4860		135
4168I		88	4585		146	4861		136
- 4176	..	159	4586		146	4862		145
- 417615	..	159	4587		149	4863		145
- 4180	..	160	4588		149	4864		145
- 4181	..	160	4589		146	4864CR		145
4185F		93	4594		126	4866		127
- 4186	..	160	459430		126	4870		145
- 4187	..	160	4596		121	4878		146
- 4189	..	160	4596N		121	4880		152
4200/A	..	443	459618		121	4881		152
4200/B	..	443	459630		121	4882		145
4200/C	..	443	4597		151	4883		146
4201I		88	4598		145	4884		148
4214		124	4599		151	4885		149
4214W		325	4603 P		85	4886		150
4228 P		94	4603WP		320	4895U		122
4228 PF		94	460308 P2		85	4900		146
4228F		93	4612		146	4900F		CG22
4233F		93	4613		146	4900S		CG22
4235		93	4622		146	4901A	.	
4247I		97	4623		146	4901B	..	
4256		123	4625U		122	4902/E	..	F/C
425614		123	4626		85	4903/E	..	459
4262		93	4626W		320	4905	..	CS67
- 4264	..	159	4627 P		85	4909	..	462
- 4265	..	159	4627WP		320	4910	.	462
4268F		93	4631		146	4911	.	462
- 4269	..	159	4639		149	4913	.	462
4273		93	4640		150	4914	.	462
4273 P		94	4642		150	4916	.	462
4276		27	4645		137	4918	.	CS66
- 4277	..	160	4646		137	4919	.	
- 4278	..	159	4647		137	4919B	.	CS66
- 4279	..	160	4648		145	4920	.	CS66
- 4280	..	160	4649		135	4920A	.	461
- 4281	..	160	4650		135	4920B	.	461
- 4282	..	160	4652		99	4920C	.	461
- 4283	..	159	4658I		88	4921	.	CG22

Codice Articolato	Euro	Pag List	Codice Articolato	Euro	Pag List	Codice Articolato	Euro	Pag List
4923	•	CG22	4954C	•	463	6005	•	465
4926	•	462	4954C2	•	463	6006	•	465
4927	•	462	49542	•	463	6007	•	465
4928	•	462	4955	•	463	6008	•	465
4929	•	462	4955C	•	463	6009	•	465
4932/E	••	459	4955C2	•	463	6010	•	465
493610	•	463	49552	•	463	6011	•	465
493610C	•	463	4956	•	463	6501	•	507
493612	•	463	4956C	•	463	6501B	•	529
493612C	•	463	4956C2	•	463	6501BD	•	528
493615	•	463	49562	•	463	6501D	•	507
493615C	•	463	4958	•	463	6502	•	507
49368	•	463	4958C	•	463	6502B	•	529
49368C	•	463	4958C2	•	463	6502BD	•	528
4937	•	463	49582	•	463	6502D	•	507
494001	••	460	4959	•	463	6503	•	507
494001M	••	460	4959C	•	463	6503B	•	529
494002	••	460	4959C2	•	463	6503BD	•	528
494002M	••	460	49592	•	463	6503D	•	507
4941	••	460	4960	•	463	6504	•	507
4941C	••	460	4960C	•	463	6504B	•	529
4941CD	••	460	4961	•	463	6504BD	•	528
4941CM	••	460	4961C	•	463	6504D	•	507
4941CMA	••	460	4962	•	463	6505	•	507
4942	•	463	4962C	•	463	6505B	•	529
4942C	•	463	4963	•	463	6505BD	•	528
4943	•	463	4963C	•	463	6505D	•	507
4943C	•	463	4964	•	463	6506	•	507
4944	•	461	4964C	•	463	6506B	•	529
4944B	•		4965	•	463	6506BD	•	528
4944N	•		4965C	•	463	6506D	•	507
4944T	•	461	4968	••	469	6507	•	509
4945	•	461	4968A	••	CG22	6507B	•	527
4945B	•	F/C	4969	••	469	6508	•	509
4945N	•	461	4970/E	•	96	6508B	•	527
4945T	•	461	4971/E	•	96	6509	•	510
4946	•	463	4972	•	459	6509B	•	528
4946C	•	463	4972/EB	••	459	6510	•	510
4946C2	•	463	4972/EBM	••	459	6510B	•	528
49462	•	463	4973/EA	••	459	6511	•	510
4947	•	463	4973/EB	••	459	6511B	•	528
4947C	•	463	4973/EC	••	459	6512	•	510
4947C2	•	463	4974/EA	••	459	6512B	•	528
49472	•	463	4974/EB	••	459	6513	•	510
4948	•	463	4984	•	461	6513B	•	528
4948C	•	463	4989	•	CG22	6514	•	510
4948C2	•	463	4990	•	460	6514B	•	528
49482	•	463	4991	•	460	6515	•	509
4949	•	463	4991B	•	460	6515B	•	527
4949C	•	463	4994	•	460	6516	•	509
4949C2	•	463	4994B	•	460	6516B	•	527
49492	•	463	4996	•	461	6517	•	509
4950	•	463	4997	•	395	6517B	•	527
4950C	•	463	4997/A	•	395	6518	•	509
4950C2	•	463	4999	•	F/C	6518B	•	527
49502	•	463	5000A	•	461	6519	•	509
4951	•	463	5001A	•	461	6519B	•	527
4951C	•	463	5002A	•	461	6520	•	509
4951C2	•	463	5100	••	460	6520B	•	527
49512	•	463	510002	••	460	6521	•	513
4952	•	463	510003	••	460	6521B	•	532
4952C	•	463	6000	•	465	6522	•	516
4952C2	•	463	6001	•	465	6522B	•	535
49522	•	463	6002	•	465	6523	•	514
4953	•	463	6003	•	465	6523B	•	533
4954	•	463	6004	•	465	6524	•	491

Codice Articolo	Euro	Pag List	Codice Articolo	Euro	Pag List	Codice Articolo	Euro	Pag List
6524B	.	524	6545B	.	532	6574	.	503
6525	.	491	6545C	.	512	6574B	.	F/C
6525B	.	524	6546	.	514	6574D3	.	505
6526	.	491	6546B	.	533	6574D7	.	504
6526B	.	524	6547	.	514	6574M2	.	477
6527	.	491	6547B	.	533	6574M3	.	483
6527B	.	524	6548	.	513	6575	.	510
6528	.	487	6548B	.	532	6575M2	.	477
6529	.	513	6548C	.	512	6575M3	.	483
6529B	.	532	6549	.	514	6576	.	510
6530	.	487	6549B	.	533	6576M2	.	477
6531	.	491	6550	.	520	6576M3	.	483
6531B	.	524	6551	.	490	6577	.	510
6531BD	.	525	6551B	.	523	6577M2	.	477
6531D	.	493	655101	.	489	6577M3	.	483
6532	.	491	655101B	.	522	6578	.	510
6532B	.	524	655102	.	489	6578M2	.	477
6532BD	.	525	655102B	.	522	6578M3	.	483
6532D	.	493	655103	.	489	6579	.	510
6533	.	491	655103B	.	522	6579M2	.	477
6533B	.	524	655104	.	489	6579M3	.	483
6533BD	.	525	655104B	.	522	6580	.	510
6533D	.	493	655105	.	489	6580M2	.	477
6534	.	491	655105B	.	522	6580M3	.	483
6534B	.	524	655106	.	489	6581	.	510
6534BD	.	525	655106B	.	522	6581M2	.	477
6534D	.	493	655107	.	489	6581M3	.	483
6535	.	491	655107B	.	522	6582	.	487
6535B	.	524	6552	.	520	6584	.	487
6535CO	.	491	6554	.	520	6586	.	487
6535D3	.	492	6556	.	509	6587	.	520
6535M2	.	477	6556B	.	527	6589	.	520
6535M3	.	483	6557	.	F/S	6591	.	520
6536	.	491	6558	.	F/S	6592	.	490
6536B	.	524	6559	.	F/S	6592B	.	523
6536CO	.	491	6562	.	F/S	6592C	.	490
6536D3	.	492	6569	.	503	6592N	.	490
6536M2	.	477	6569B	.	F/C	659202	.	489
6536M3	.	483	6569D3	.	505	659202B	.	522
6537	.	491	6569D7	.	504	6593	.	515
6537B	.	524	6569M2	.	477	6593B	.	534
6537CO	.	491	6569M3	.	483	6594	.	513
6537D3	.	492	6570	.	503	6594B	.	532
6537M2	.	477	6570B	.	F/C	6595	.	510
6537M3	.	483	6570D3	.	505	6596	.	510
6538	.	491	6570D7	.	504	6597	.	503
6538B	.	524	6570M2	.	477	6597B	.	F/C
6538CO	.	491	6570M3	.	483	6597D3	.	505
6538D3	.	492	6571	.	503	6597D7	.	504
6538M2	.	477	6571B	.	F/C	6597M2	.	477
6538M3	.	483	6571D3	.	505	6597M3	.	483
6539	.	514	6571D7	.	504	6598	.	503
6539B	.	533	6571M2	.	477	6598B	.	F/C
6540	.	513	6571M3	.	483	6598D3	.	505
6540B	.	532	6572	.	503	6598D7	.	504
6541	.	487	6572B	.	F/C	6598M2	.	477
6542	.	490	6572D3	.	505	6598M3	.	483
6542B	.	523	6572D7	.	504	6602	.	F/S
6543	.	490	6572M2	.	477	6605	.	F/S
6543B	.	523	6572M3	.	483	6606	.	F/S
6543C	.	490	6573	.	503	6609	.	513
6543N	.	490	6573B	.	F/C	6609B	.	532
6544	.	513	6573D3	.	505	6609C	.	512
6544B	.	532	6573D7	.	504	6610	.	513
6544C	.	512	6573M2	.	477	6610B	.	532
6545	.	513	6573M3	.	483	6611	.	488

Codice Articolo	Euro	Pag List	Codice Articolo	Euro	Pag List	Codice Articolo	Euro	Pag List
6612	*	488	6647B	*	527	6682D	*	508
6613	*	488	6648	*	510	6682M2	*	478
6614	*	516	6648M2	*	477	6682M3	*	484
6614B	*	535	6648M3	*	483	6683	*	508
6615	*	516	6649	*	510	6683B	*	530
6615B	*	535	6649M2	*	477	6683BD	*	531
6616	*	521	6649M3	*	483	6683D	*	508
6617	*	521	6650	*	510	6683M2	*	478
6618	*	521	6650M2	*	477	6683M3	*	484
6619	*	515	6650M3	*	483	6684	*	511
6619B	*	534	6651	*	510	6684B	*	526
6621	*	F/S	6651M2	*	477	6685	*	508
6622	*	F/S	6651M3	*	483	6685B	*	526
6623	*	490	6652	*	509	6685M2	*	478
6623B	*	523	6652B	*	527	6685M3	*	484
6624	*	513	6653	*	509	6686	*	508
6624B	*	532	6653B	*	527	6686B	*	526
6624C	*	512	6654	*	516	6686M2	*	478
6625	*	513	6654B	*	535	6686M3	*	484
6625B	*	532	6655	*	516	6687	*	513
6626	*	514	6655B	*	535	6687B	*	532
6626B	*	533	6656	*	520	6688	*	515
6626M2	*	514	6658	*	520	6688B	*	534
6626M3	*	514	6659	*	515	6695	*	511
6627	*	514	6659B	*	534	6695B	*	530
6627B	*	533	6660	*	520	6695M2	*	478
6628	*	514	6663	*	516	6695M3	*	484
6628B	*	533	6663B	*	535	6696	*	511
6629	*	491	6664	*	516	6696B	*	530
6629B	*	524	6664B	*	535	6696M2	*	478
6629CO	*	491	6668	*	516	6696M3	*	484
6629D3	*	492	6668B	*	535	6697	*	511
6629M2	*	477	6669	*	511	6697B	*	530
6629M3	*	483	6669B	*	530	6697M2	*	478
6630	*	492	6670	*	490	6697M3	*	484
6630B	*	525	6670B	*	523	6698	*	511
6631	*	492	6670C	*	490	6698B	*	530
6631B	*	525	6670N	*	490	6698M2	*	478
6632	*	492	6671	*	490	6698M3	*	484
6632B	*	525	6671B	*	523	6699	*	511
6633	*	492	6671C	*	490	6699B	*	530
6633B	*	525	6671N	*	490	6699M2	*	478
6634	*	515	6672	*	506	6699M3	*	484
6634B	*	534	6672B	*	531	6700	*	511
6634C	*	512	6673	*	506	6700B	*	530
6635	*	515	6673B	*	531	6700M2	*	478
6635B	*	534	6674	*	513	6700M3	*	484
6636	*	487	6674B	*	532	6701	*	506
6637	*	516	6674C	*	512	6701B	*	531
6637B	*	535	6675	*	506	6702	*	506
6638	*	487	6675B	*	531	6702B	*	531
6639	*	515	6676	*	506	6703	*	492
6640	*	487	6676B	*	531	6703B	*	524
6641	*	493	6677	*	514	6703CL	*	492
6641B	*	529	6677B	*	533	6703CO	*	491
6642	*	493	6677C	*	512	6703C2	*	492
6642B	*	529	6678	*	515	6704	*	492
6643	*	493	6678B	*	534	6704B	*	524
6643B	*	529	6679	*	513	6704CL	*	492
6644	*	509	6679B	*	532	6704CO	*	491
6644B	*	527	6680	*	516	6704C2	*	492
6645	*	509	6680B	*	535	6705	*	492
6645B	*	527	6681	*	491	6705B	*	524
6646	*	509	6682	*	508	6705CL	*	492
6646B	*	527	6682B	*	530	6705CO	*	491
6647	*	509	6682BD	*	531	6705C2	*	492

Codice Articolo	Euro	Pag List	Codice Articolo	Euro	Pag List	Codice Articolo	Euro	Pag List
6706	.	492	6756CO	.	496	6785M3	.	F/C
6706B	.	524	6756C1	.	495	6786M2	.	F/C
6706CL	.	492	6757	.	495	6786M3	.	F/C
6706CO	.	491	6757CO	.	496	6787M2	.	F/C
6706C2	.	492	6757C1	.	495	6787M3	.	F/C
6707	.	492	6758	.	495	6801	.	494
6707B	.	524	6758CO	.	496	6802	.	494
6707CL	.	492	6758C1	.	495	6803	.	494
6707CO	.	491	6759	.	495	6804	.	494
6707C2	.	492	6759CO	.	496	6805	.	494
6709	.	511	6759C1	.	495	6806	.	494
6709B	.	530	6760	.	495	6807	.	494
6709M2	.	478	6760CO	.	496	6808	.	494
6709M3	.	484	6760C1	.	495	6809	.	494
6716	.	511	6761	.	495	6810	.	494
6716B	.	530	6761CO	.	496	6811	.	494
6716M2	.	478	6761C1	.	495	6812	.	494
6716M3	.	484	6762CO	.	496	694001	.	
6735	.	502	6762C1	.	495	694002	.	
6735B	.	526	6763CO	.	496	694003	.	
6736	.	502	6763C1	.	495	694004	.	
6736B	.	526	6764CO	.	498	694005	.	
6737	.	502	6764C1	.	497	694006	.	
6737B	.	526	6765CO	.	498	694007	.	
6738	.	502	6765C1	.	497	694007A	.	
6738B	.	526	6766CO	.	498	694008	.	
6739	.	502	6766C1	.	497	7000	.	F/C
6739B	.	526	6767CO	.	498	7001	.	F/C
6740	.	502	6767C1	.	497	7002	.	F/C
6740B	.	526	6768CO	.	498	7003	.	F/C
6741	.	F/C	6768C1	.	497	7004	.	F/C
6742	.	F/C	6769CO	.	498	7007	.	97
6743	.	F/C	6769C1	.	497	7008	.	31
6745	.	502	6770CO	.	498	7009	.	F/C
6745B	.	526	6770C1	.	497	-7011	.	9
6746	.	502	6771CO	.	498	-7012	.	9
6746M2	.	476	6771C1	.	497	-7013	.	9
6746M3	.	482	6772CL	.	501	7015	.	9
6747	.	502	6772CO	.	500	7016	.	21
6747M2	.	476	6772C2	.	499	7016H	.	379
6747M3	.	482	6773CL	.	501	7016J	.	284
6748	.	502	6773CO	.	500	7016K	.	243
6748M2	.	476	6773C2	.	499	7016L	.	264
6748M3	.	482	6774CL	.	501	7016N	.	22
6749	.	502	6774CO	.	500	7016W	.	315
6749M2	.	476	6774C2	.	499	7017	.	21
6749M3	.	482	6775CL	.	501	7017H	.	379
6750	.	502	6775CO	.	500	7017J	.	284
6750M2	.	476	6775C2	.	499	7017K	.	243
6750M3	.	482	6776CL	.	501	7017L	.	264
6751	.	502	6776CO	.	500	7017N	.	22
6751M2	.	476	6776C2	.	499	7017W	.	315
6751M3	.	482	6777CL	.	501	7018	.	97
6752	.	502	6777CO	.	500	7019	.	97
6752M2	.	476	6777C2	.	499	7020	.	CS04
6752M3	.	482	6778CL	.	501	7021	.	CS04
6753	.	502	6778CO	.	500	7022	.	CS04
6753M2	.	476	6778C2	.	499	7023	.	CS04
6753M3	.	482	6779CL	.	501	7024	.	21
6754	.	495	6779CO	.	500	7024H	.	379
6754CO	.	496	6779C2	.	499	7024J	.	284
6754C1	.	495	6783	.	513	7024K	.	243
6755	.	495	6783C	.	512	7024L	.	264
6755CO	.	496	6784M2	.	F/C	7024N	.	22
6755C1	.	495	6784M3	.	F/C	7024W	.	315
6756	.	495	6785M2	.	F/C	7025	.	21

Codice Articolo	Euro	Pag List	Codice Articolo	Euro	Pag List	Codice Articolo	Euro	Pag List
7025H		379	703510		155	7069 P		71
7025J		284	703515		155	7069JP		290
7025K		243	7036		121	7069KP		249
7025L		264	7037		121	7069LP		270
7025N		22	7038		121	7069WP		322
7025W		315	7039		121	7070		71
7026		106	- 7040	--	121	7070J		290
7027		CS04	7041 R		75	7070K		249
702818		104	7041HR		380	7070L		270
7028181		104	7041NR		76	7070W		322
7028182		104	7041WR		318	7071 P		71
7028183		104	7042 R		75	7071JP		290
7028184		104	7042HR		380	7071KP		249
7028185		104	7042NR		76	7071LP		270
7028189		F/C	7042WR		318	7071WP		322
702914		103	7043 R		75	7072		71
702914A		CG31	7043HR		380	7072J		290
7029141		CG31	7043NR		76	7072K		249
70291411		103	7050		105	7072L		270
70291412		103	7051		16	7072W		322
70291413		103	7051J		283	7073		79
70291414		F/C	7051K		242	7074		79
70291415		103	7051L		263	707480		103
70291416		F/C	7051W		314	70748001		103
70291417		103	7055		23	70748001A		103
7029142		CG31	7055JU		284	707508		32
7029143		103	7055KU		243	707512		32
7029144		103	7055LU		264	7076		157
7029145		CG31	7055W		315	7076W		323
7029146		CG31	7058 P		85	7077		155
7029149		CG31	7058JP		289	7078		26
702918		104	7058KP		248	707901		149
7029181		104	7058LP		270	707902		149
70291811		104	7058WP		322	707903		149
70291812		F/C	7059		85	7080		23
70291813		104	7059J		289	7080J		284
70291814		F/C	7059K		248	7080JU		284
70291815		104	7059L		270	7080K		243
70291816		F/C	7059W		322	7080KU		243
70291817		F/C	7062		21	7080L		264
7029182		104	7062H		379	7080LU		264
7029183		104	7062J		284	7080W		315
7029184		104	7062K		243	7080WU		315
7029185		CG31	7062L		264	7081		23
7029186		104	7062N		22	7081J		284
7029187		CG31	7062W		315	7081JU		284
7029188		CG31	7063		21	7081K		243
7029189		CG31	7063H		379	7081KU		243
7030		129	7063J		284	7081L		264
- 7031	--	129	7063K		243	7081LU		264
7032		31	7063L		264	7081W		315
7033		21	7063N		22	7081WU		315
7033H		379	7063W		315	7084		78
7033J		284	7064		105	7085		78
7033K		243	7064N		105	7086		101
7033L		264	7064P		77	7086J		288
7033N		22	7065		105	7086K		247
7033W		315	7065N		105	7086L		268
7034		21	7065P		77	7086NL		363
7034H		379	7067		99	7086W		322
7034J		284	7067W		319	7086Y		353
7034K		243	7067Y		354	7087 P		101
7034L		264	706717		99	7087JP		288
7034N		22	706717W		319	7087KP		247
7034W		315	706717Y		354	7087LP		268
703507		155	7068		17	7087NLP		363

Codice Articolo	Euro	Pag List	Codice Articolo	Euro	Pag List	Codice Articolo	Euro	Pag List
7087WP		322	7107 R		66	7119 P		66
7087YP		353	7107JP		287	7119 R		66
708701 P		101	7107JR		287	7119JP		287
708702 P		101	7107KP		246	7119JR		287
708703N P		101	7107KR		246	7119KP		246
708703R P		101	7107LP		267	7119KR		246
708703W P		101	7107LR		267	7119LP		267
7088		101	7107WP		320	7119LR		267
7088J		288	7107WR		320	7119WR		320
7088K		247	7108 P		66	7120 P		66
7088L		268	7108 R		66	7120 R		66
7088NL		363	7108JP		287	7120JP		287
7088W		322	7108JR		287	7120JR		287
7088Y		353	7108KP		246	7120KP		246
7089 P		101	7108KR		246	7120KR		246
7089JP		288	7108LP		267	7120LP		267
7089KP		247	7108LR		267	7120LR		267
7089LP		268	7108WP		320	7120WR		320
7089NLP		363	7108WR		320	7121		32
7089WP		322	7109		66	7122		29
7089YP		353	7109J		287	712309		29
7090		79	7109K		246	712310		29
7091 P		79	7109L		267	712311		29
7092 P		79	7109W		320	712312		29
7093 P		79	7110		66	7124		CS04
7096		7	7110J		287	7125		CS04
7097		99	7110K		246	7126		CS04
7097W		319	7110L		267	7127		CS04
7097Y		354	7110W		320	7128		CS04
709717		99	7111		23	7129 P		105
709717W		319	7111J		283	7130/D		148
709717Y		354	7111K		242	7130/S		148
7098		23	7111L		263	7131/D		148
7098J		283	7111W		316	7131/S		148
7098K		242	7112		23	7132		
7098L		263	7112J		283	7133 R	**	42
7098W		316	7112K		242	7134	**	42
7100 P		64	7112L		263	7135 R	**	39
7100 R		F/S	7112W		316	713617	**	122
7100WR		321	7113		23	713617A		NVO
7101		64	7113J		283	7137		105
7101W		321	7113K		242	7138		312
7102 P		64	7113L		263	7139		312
7102 R		64	7113W		316	7140		312
7102WP		321	7115		23	7141		7
7102WR		321	7115J		283	714101		7
7103 P		64	7115K		242	714102		F/C
7103 R		F/S	7115L		263	7148		239
7103WR		321	7115W		316	7149		239
7104		64	7116		23	7150		239
7104W		321	7116J		283	7151		239
7105 P		64	7116K		242	7152		239
7105 R		64	7116L		263	7153		32
7105WP		321	7116W		316	715312		32
7105WR		321	7117		66	7154		32
7106 P		66	7117E	.	96	7155		161
7106 R		66	7117J		287	7156		161
7106JP		287	7117K		246	7157		32
7106JR		287	7117L		267	7158		32
7106KP		246	7117W		320	7159		33
7106KR		246	7118		66	715908		33
7106LP		267	7118E	.	96	7160		33
7106LR		267	7118J		287	716008		33
7106WP		320	7118K		246	7161		121
7106WR		320	7118L		267	7161J		294
7107 P		66	7118W		320	7161K		253

Codice Articolo	Euro	Pag List	Codice Articolo	Euro	Pag List	Codice Articolo	Euro	Pag List
7161L		274	7188/E		96	7242 R		75
7161W		325	7190 R		89	7242HR		380
716116		121	7190PR	..	89	7242NP		76
716116W		325	7191 R	..	89	7242NR		76
7162		121	7191PR	..	89	7242PR		77
7163		33	7192	..	89	7242WP		318
716308		33	7192P	..	89	7242WR		318
716308H		382	7193	..	89	7243 P		75
7164		33	7193P	..	89	7243 R		75
716408		33	- 7194	..	89	7243HR		380
716408H		382	- 7194P	..	89	7243NP		76
7165		33	- 7195	..	89	7243NR		76
716508		33	- 7195P	..	89	7243PR		77
716508H		382	7196 P	..	F/C	7243WP		318
7166		153	7196 R	..	89	7243WR		318
7166H		381	7196PR	..	89	7244 P		75
7166N		153	7197	..	89	7244 R		75
7166W		323	7197P	..	89	7244HR		380
7167		153	7198 P	..	71	7244NP		76
7167H		381	7198JP	..	290	7244NR		76
7167N		153	7198KP	..	249	7244PR		77
7167W		324	7198LP	..	270	7244WR		318
7168		150	7198WP	..	322	7245		75
7169		312	719930	..	122	7245H		380
7170		312	7200 P	..	79	7245N		76
7171		312	7201	..	79	7245P		77
7172		312	7202 P	..	79	7245W		318
7174		312	7203 P	..	79	7246		75
7175		32	7204	..	79	7246H		380
717508		32	7205 P	..	79	7246N		76
717717		125	7206 P	..	79	7246P		77
7178 P		100	7207	..	24	7246W		318
7178JP		290	7208	..	24	7247		75
7178KP		249	7209	..	312	7247H		380
7178LP		269	7210	..	312	7247N		76
717901		149	7211	..	D098	7247P		77
717902		149	7212	..	D098	7247W		318
7180J		284	7213	..	D098	7248 P		75
7180K		243	7214 P	..	D098	7248 R		75
7180L		264	7215	..	D098	7248HR		380
7180W		315	7216 P	..	D098	7248NP		76
7181 R		73	7217 P	..	D098	7248NR		76
7181HR		379	7218	..	D098	7248PR		77
7181JR		286	7219 P	..	D098	7248WP		318
7181KR		245	7220	..	79	7248WR		318
7181LR		266	7221	..	4	7249 P		75
7181NR		74	7222	..	4	7249 R		75
7181WR		317	7223	..	4	7249HR		380
7182 R		73	7224	..	4	7249NP		76
7182HR		379	7225	..	377	7249NR		76
7182JR		286	7226	..	4	7249PR		77
7182KR		245	7228	..	156	7249WP		318
7182LR		266	7229	..	95	7249WR		318
7182NR		74	7230	..	35	7250 P		75
7182WR		317	7231	..	35	7250HP		380
7183 R		73	7232	..	35	7250NP		76
7183HR		379	7233	..	35	7251		75
7183JR		286	7234	..	35	7251H		380
7183KR		245	7235	..	35	7251N		76
7183LR		266	7236	..	35	7251P		77
7183NR		74	7237	..	35	7252		75
7183WR		317	7238	..	35	7252H		380
7186		159	7239	..	35	7252N		76
7186W		324	7240	..	35	7252P		77
7187		145	7241	..	35	7253 P		73
7188		106	7242 P	..	75	7253 R		73

Codice Articolo	Euro	Pag List	Codice Articolo	Euro	Pag List	Codice Articolo	Euro	Pag List
7253HR		379	7259LR		266	7290J	*	281
7253JP		286	7259NP		74	7290K	*	240
7253JR		286	7259NR		74	7290L	*	261
7253KP		245	7259WP		317	7290NL	*	361
7253KR		245	7259WR		317	7291	*	8
7253LP		266	7260 P		73	7291H	*	378
7253LR		266	7260 R		73	7291J	*	281
7253NP		74	7260HR		379	7291K	*	240
7253NR		74	7260JP		286	7291L	*	261
7253WP		317	7260JR		286	7291NL	*	361
7253WR		317	7260KP		245	7292	*	8
7254 P		73	7260KR		245	7292H	*	378
7254 R		73	7260LP		266	7292J	*	281
7254HR		379	7260LR		266	7292K	*	240
7254JP		286	7260NP		74	7292L	*	261
7254JR		286	7260NR		74	7292NL	*	361
7254KP		245	7260WP		317	7293	*	8
7254KR		245	7260WR		317	7293H	*	378
7254LP		266	7261		73	7293J	*	281
7254LR		266	7261H		379	7293K	*	240
7254NP		74	7261J		286	7293L	*	261
7254NR		74	7261K		245	7293NL	*	361
7254WP		317	7261L		266	7294	*	8
7254WR		317	7261N		74	7294H	*	378
7255 P		73	7261W		317	7294J	*	281
7255 R		73	7262		73	7294K	*	240
7255HR		379	7262H		379	7294L	*	261
7255JP		286	7262J		286	7294NL	*	361
7255JR		286	7262K		245	7295	*	8
7255KP		245	7262L		266	7295H	*	378
7255KR		245	7262N		74	7295J	*	281
7255LP		266	7262W		317	7295K	*	240
7255LR		266	7263		95	7295L	*	261
7255NP		74	7264		121	7295NL	*	361
7255NR		74	7264H		381	7296	*	8
7255WP		317	7265		121	7296H	*	378
7255WR		317	7265H		381	7296J	*	281
7256		73	7266		121	7296K	*	240
7256H		379	7266H		381	7296L	*	261
7256J		286	7267		121	7296NL	*	361
7256K		245	7267H		381	7297	*	8
7256L		266	7268		121	7297H	*	378
7256N		74	7269		121	7297J	*	281
7256W		317	- 7270	**	121	7297K	*	240
7257		73	727101		125	7297L	*	261
7257H		379	727102		125	7297NL	*	361
7257J		286	727103		125	7298	*	8
7257K		245	727217		125	7298H	*	378
7257L		266	7273		129	7298J	*	281
7257N		74	7274		129	7298K	*	240
7257W		317	- 7275	**	129	7298L	*	261
7258		73	- 7277 R	**	112	7298NL	*	361
7258H		379	- 7277NR	**	112	7299	*	8
7258J		286	7278 R		75	7299H	*	378
7258K		245	7278NR		76	7299J	*	281
7258L		266	7279		75	7299K	*	240
7258N		74	7279N		76	7299L	*	261
7258W		317	7280		109	7299NL	*	361
7259 P		73	7280N		109	7300	*	159
7259 R		73	7281		122	7300W	*	324
7259HR		379	7282		153	730001OT	*	159
7259JP		286	7283		153	7301 P	*	63
7259JR		286	7289		159	7301WP	*	318
7259KP		245	7289W		324	7301YP	*	352
7259KR		245	7290	*	8	730114 P	*	102
7259LP		266	7290H	*	378	730114WP	*	318

Codice Articolo	Euro	Pag List	Codice Articolo	Euro	Pag List	Codice Articolo	Euro	Pag List
730114YP		352	7309W		320	7321J	*	280
7302 P		64	7310 P		64	7321K	*	239
7302 R		64	7310JP		287	7321L	*	260
7302JP		287	7310JR		287	7323		64
7302JR		287	7310KP		246	7323J		287
7302KP		246	7310KR		246	7323K		246
7302KR		246	7310LP		267	7323L		267
7302LP		267	7310LR		267	7323W		320
7302LR		267	7310WP		320	7324 P		67
7302WP		320	7310WR		320	7324JP		288
7302WR		320	7311 P		72	7324KP		247
7303 P		64	7311 R		F/S	7324LP		268
7303 R		64	7311JPU	*	290	7325	*	8
7303JP		287	7311JRU	*	290	7325H	*	377
7303JR		287	7311KPU	*	249	7325J	*	280
7303KP		246	7311KRU	*	249	7325K	*	239
7303KR		246	7311LPU	*	270	7325L	*	260
7303LP		267	7311LRU	*	270	7326 P		67
7303LR		267	7311UR	*	72	7326JP		288
7303WP		320	7312		72	7326JR		288
7303WR		320	7312JU		290	7326KP		247
7304		64	7312KU		249	7326KR		247
7304J		287	7312LU		270	7326LP		268
7304K		246	7312U		72	7326LR		268
7304L		267	7313	*	8	7326WP		321
7304W		320	7313H	*	377	7326WR		321
7305 P		64	7313J	*	280	7327 P		67
7305JP		287	7313K	*	239	7327JP		288
7305JR		287	7313L	*	260	7327JR		288
7305KP		246	7314	*	8	7327KP		247
7305KR		246	7314H	*	377	7327KR		247
7305LP		267	7314J	*	280	7327LP		268
7305LR		267	7314K	*	239	7327LR		268
7305WP		320	7314L	*	260	7327WP		321
7305WR		320	7315	*	8	7327WR		321
7306 P		72	7315H	*	377	7328		67
7306 R		F/S	7315J	*	280	7328J		288
7306JPU		290	7315K	*	239	7328K		247
7306JRU		290	7315L	*	260	7328L		268
7306KPU		249	7316	*	8	7328W		321
7306KRU		249	7316H	*	377	7329 P		67
7306LPH		270	7316J	*	280	7329JP		288
7306LPU		270	7316K	*	239	7329JR		288
7306LRH		270	7316L	*	260	7329KP		247
7306LRU		270	7317	*	8	7329KR		247
7306UR		72	7317H	*	377	7329LP		268
7307		72	7317J	*	280	7329LR		268
7307JU		290	7317K	*	239	7329WP		321
7307KU		249	7317L	*	260	7329WR		321
7307LH		270	7318	*	8	7330 P		67
7307LU		270	7318H	*	377	7330JP		288
7307U		72	7318J	*	280	7330JR		288
7308 P		64	7318K	*	239	7330KP		247
7308 R		64	7318L	*	260	7330KR		247
7308JP		287	7319	*	8	7330LP		268
7308JR		287	7319H	*	377	7330LR		268
7308KP		246	7319J	*	280	7330WP		321
7308KR		246	7319K	*	239	7330WR		321
7308LP		267	7319L	*	260	7331		67
7308LR		267	7320	*	8	7331J		288
7308WP		320	7320H	*	377	7331K		247
7308WR		320	7320J	*	280	7331L		268
7309		64	7320K	*	239	7331W		321
7309J		287	7320L	*	260	7332 P		99
7309K		246	7321	*	8	7333		99
7309L		267	7321H	*	377	7334		99

Codice Articolo	Euro	Pag List	Codice Articolo	Euro	Pag List	Codice Articolo	Euro	Pag List
7335		99	734514K		244	736314WP		318
7336 P		61	734514L		265	736314YP		352
7336JP		285	734514NL		363	7364		63
7336KP		244	734514W		319	7364W		318
7336LP		265	734514Y		353	7364Y		352
7336WP		319	734523		61	736414		102
7337 P		61	734523J		285	736414W		318
7337JP		285	734523K		244	736414Y		352
7337KP		244	734523L		265	7365 P		63
7337LP		265	734523W		319	7365WP		318
7337WP		319	7346		21	7365YP		352
733713 P		102	7346H		380	7366		2
733713JP		285	7346N		22	7366J		279
733713KP		244	7346P		77	7366K		238
733713LP		265	7347		21	7366L		259
733713NLP		363	7347H		380	7366W		312
733713WP		319	7347N		22	7371		
733713YP		353	7347P		77	7372		88
7338/H		99	7348 P		61	7373		88
7338N/H		99	7348JP		285	7374		88
7338R/H		99	7348KP		244	7376		376
7338W/H		99	7348LP		265	7377		376
733801/H		99	7348WP		319	7378		376
733802/H		99	7349		21	7379		376
733803/H		99	7349H		380	7380		376
7339		61	7349N		22	7381		124
7339J		285	7349P		77	7382		108
7339K		244	734908		21	7382J		292
7339L		265	7350		21	7382K		251
7339W		319	7350H		380	7382L		272
733914		102	7350N		22	7382U		108
733914J		285	7350P		77	7382Y		354
733914K		244	7351		63	738308		33
733914L		265	7351W		318	7384		376
733914NL		363	7351Y		352	7385		238
733914W		319	735114		102	7386		238
733914Y		353	735114W		318	7387		238
733923		61	735114Y		352	7388		238
7340		377	7352		21	7389		238
7341		377	7352H		380	739008		33
7342		377	7352N		22	7391 P		99
7343		377	7352P		77	7391JP		288
7344 P		61	7353		21	7391KP		247
7344JP		285	7353H		380	7391LP		268
7344KP		244	7353N		22	7391WP		319
7344LP		265	7353P		77	7391YP		354
7344WP		319	735421		104	7392 P		106
734413 P		102	735427		104	7393		238
734413JP		285	7355		21	739911		104
734413KP		244	7355H		380	7401 P		63
734413LP		265	7355N		22	7401WP		318
734413NLP		363	7355P		77	7401YP		352
734413WP		319	7356		21	7408 P		60
734413YP		353	7356H		380	7408JP		285
734430 P		61	7356N		22	7408KP		244
734430JP		285	7356P		77	7408LP		265
734430KP		244	735718		104	7408NLP		364
734430LP		265	7358		2	7408V3P		335
734430WP		319	7359		2	7408V4P		335
7345		61	7360		2	7408WP		322
7345J		285	7361		3	7408YP		352
7345K		244	7362		3	7409 P		60
7345L		265	7363 P		63	7409JP		285
7345W		319	7363WP		318	7409KP		244
734514		102	7363YP		352	7409LP		265
734514J		285	736314 P		102	7409NLP		364

Codice Articolo	Euro	Pag List	Codice Articolo	Euro	Pag List	Codice Articolo	Euro	Pag List
7409WP		322	7432NLP		363	7471		280
7409YP		352	7432WP		320	7472		280
7410 P		60	7432YP		353	7473		2
7410JP		285	7433		101	7474		2
7410KP		244	7433J		287	7475		2
7410LP		265	7433K		246	7476		3
7410NLP		364	7433L		267	7477		2
7410V3P		335	7433NL		363	7477J		279
7410V4P		335	7433W		320	7477K		238
7410WP		322	7433Y		353	7477L		259
7410YP		352	7434		101	- 7478 P	..	92
7417		60	7434J		287	- 7478 R	..	92
7417J		285	7434K		246	- 7479 R	..	92
7417K		244	7434L		267	7480		103
7417L		265	7434NL		363	- 7481	..	92
7417NL		364	7434W		320	- 7482	..	92
7417V3		335	7434Y		353	7483 P		60
7417V4		335	7435		105	7483JP		285
7417W		322	7435N		105	7483KP		244
7417Y		352	7436 P		105	7483LP		265
7418		312	7436NP		105	7483NLP		364
7419		312	7437		17	7483V3P		335
7421		3	743701		17	7483V4P		335
7421H		376	743702		17	7483WP		322
7421J		279	7438/H		99	7483YP		352
7421K		238	7438N/H		99	- 7484 P	..	92
7421L		259	7438R/H		99	- 7484 R	..	92
7422		3	7438W/H		99	- 7485 R	..	92
7422H		376	743801/H		99	- 7486 P	..	92
7422J		279	743802/H		99	- 7486 R	..	92
7422K		238	743803/H		99	- 7487 R	..	92
7422L		259	7439		20	7488		60
7423		3	7440		12	7488J		285
7423H		376	7441		12	7488K		244
7423J		279	7442		12	7488L		265
7423K		238	7443		12	7488NL		364
7423L		259	7444		12	7488V3		335
7424		3	7445 P		105	7488V4		335
7424H		376	7445NP		105	7488W		322
7424J		279	7445PP		77	7488Y		352
7424K		238	7446 P		75	- 7489	..	92
7424L		259	7446NP		76	- 7490	..	92
7425		3	7446PP		77	- 7491	..	152
7425H		376	7447 P		88	- 7492 P	..	92
7425J		279	7448 P		F/C	- 7492 R	..	92
7425K		238	7449 P		88	- 7493 R	..	92
7425L		259	7451		259	- 7500	..	27
7426		280	7452		259	- 7501	..	27
7427 P		56	7453		259	- 7502	..	27
742701 P		100	7454		259	- 7503	..	27
7428 P		56	7455		259	- 7504	..	27
742801 P		100	7456		259	- 7505	..	27
7429		28	7457		279	- 7506	..	27
7430 P		56	7458		279	- 7507	..	27
743001 P		100	7459		279	- 7518 P	..	91
7431 P		101	7460		279	- 7518 R	..	91
7431JP		287	7461		279	- 7519 R	..	91
7431KP		246	7462		279	- 7520 P	..	91
7431LP		267	7463		260	- 7520 R	..	91
7431NLP		363	7464		260	- 7521 R	..	91
7431WP		320	7465		260	- 7522	..	91
7431YP		353	7466		260	- 7523	..	91
7432 P		101	7467		260	- 7524	..	102
7432JP		287	7468		280	- 7525	..	102
7432KP		246	7469		280	- 7526 P	..	102
7432LP		267	7470		280	- 7527 P	..	102

Codice Articolo	Euro	Pag List	Codice Articolo	Euro	Pag List	Codice Articolo	Euro	Pag List
-7528 P	**	91	7549		131	756908 P		99
-7529	**	102	7550 P		63	7570		1
-7530	**	102	7550WP		318	7572		1
-7531 P	**	102	7550YP		352	7574		1
-7532 P	**	102	755014 P		102	7575		1
-7533 P	**	92	755014WP		318	7577		1
-7534	**	92	755014YP		352	7580		1
-7535	**	91	755029 P		63	7582		131
7536		17	755029WP		318	7583		131
7537		17	755029YP		352	7584		131
7538 P		62	7551		63	7585		131
7538WP		319	7551W		318	7586		131
7539 P		62	7551Y		352	7587		132
7539WP		319	755114		102	758701		132
753908 P		102	755114W		318	7588		260
753913 P		102	755114Y		352	7589		239
753913NLP		363	755126		63	7590		4
753913WP		319	755126W		318	7591		4
753913YP		353	755126Y		352	759409		123
753916 P		62	7552 P		63	759414		123
753916WP		319	7552WP		318	759514		123
753930 P		62	7552YP		352	759614		152
753930WP		319	755214 P		102	759618		152
7540		62	755214BZ P		101	759714		152
7540W		319	755214WP		318	759721		152
754014		102	755214YP		352	759814		152
754014NL		363	7553		63	760014		123
754014W		319	7553W		318	7606	**	145
754014Y		353	7553Y		352	-7607 P		84
754023		62	755314		102	7608	**	142
7541		62	755314W		318	7608CW	**	142
7541W		319	755314Y		352	7608DW	**	142
7542		159	7554 P		63	7609	**	142
7542A	▲	F/C	7554WP		318	7609CW	**	142
7542B	▲	F/C	7554YP		352	7609DW	**	142
7542C	▲	F/C	7555 P		63	761000	*	10
7542P		159	7555WP		318	761000J	*	278
7542PB	▲	F/C	7555YP		352	761000K	*	237
7542PC	▲	F/C	7556		20	761000L	*	258
7543 P		60	7557		20	761000Y	*	351
7543JP		285	7558		20	761015	*	10
7543KP		244	7559		20	761015J	*	278
7543LP		265	7559W		313	761015K	*	237
7543NLP		364	7565		97	761015L	*	258
7543V3P		335	7565J		292	761015Y	*	351
7543V4P		335	7565K		251	761020	*	10
7543WP		322	7565L		272	761020J	*	278
7543YP		352	756501		NVO	761020K	*	237
7544 P		62	7566		19	761020L	*	258
7544WP		319	7566W		313	761020Y	*	351
754413 P		102	756601		19	761025	*	10
754413NLP		363	756601W		313	761025J	*	278
754413WP		319	756602		19	761025K	*	237
754413YP		353	756602W		313	761025L	*	258
7545		62	7567		19	761025Y	*	351
7545W		319	7567W		313	761030	*	10
754514		102	756701		19	761030J	*	278
754514NL		363	756701W		313	761030K	*	237
754514W		319	756702		19	761030L	*	258
754514Y		353	756702W		313	761030Y	*	351
7546		131	7568		19	761040	*	10
754601		132	7568W		313	761040J	*	278
754602		132	756801		19	761040K	*	237
7547		131	756801W		313	761040L	*	258
7548 P		62	756802		19	761040Y	*	351
7548WP		319	756802W		313	761050	*	10

Codice Articollo	Euro	Pag List	Codice Articollo	Euro	Pag List	Codice Articollo	Euro	Pag List
761050J	*	278	7619AG	**	147	763000J	*	278
761050K	*	237	7619CN	**	147	763000K	*	237
761050L	*	258	7619CR	**	147	763000L	*	258
761050Y	*	351	7619CW	**	147	763000Y	*	351
761060	*	10	7619RA	**	147	763015	*	10
761060J	*	278	7619U	**	147	763015J	*	278
761060K	*	237	76193	**	147	763015K	*	237
761060L	*	258	76193CN	**	147	763015L	*	258
761060Y	*	351	76193CR	**	147	763015Y	*	351
761080	*	10	76193CW	**	147	763020	*	10
761080J	*	278	762000	*	10	763020J	*	278
761080K	*	237	762000J	*	277	763020K	*	237
761080L	*	258	762000K	*	237	763020L	*	258
761080Y	*	351	762000L	*	257	763020Y	*	351
761099	*	10	762000Y	*	351	763025	*	10
761099J	*	278	762015	*	10	763025J	*	278
761099K	*	237	762015J	*	277	763025K	*	237
761099L	*	258	762015K	*	237	763025L	*	258
761099Y	*	351	762015L	*	257	763025Y	*	351
7611	**	141	762015Y	*	351	763030	*	10
7611CG	**	141	762020	*	10	763030J	*	278
7611CR	**	141	762020J	*	277	763030K	*	237
7611CW	**	141	762020K	*	237	763030L	*	258
7611DG	**	141	762020L	*	257	763030Y	*	351
7611DR	**	141	762020Y	*	351	763040	*	10
7611DW	**	141	762025	*	10	763040J	*	278
7612	**	139	762025J	*	277	763040K	*	237
7612CG	**	139	762025K	*	237	763040L	*	258
7612CR	**	139	762025L	*	257	763040Y	*	351
7612CRG	**	139	762025Y	*	351	763050	*	10
7612CW	**	139	762030	*	10	763050J	*	278
7612CWG	**	139	762030J	*	277	763050K	*	237
7612DG	**	139	762030K	*	237	763050L	*	258
7612DR	**	139	762030L	*	257	763050Y	*	351
7612DRG	**	139	762030Y	*	351	763060	*	10
7612DW	**	139	762040	*	10	763060J	*	278
7613	**	141	762040J	*	277	763060K	*	237
7613CG	**	141	762040K	*	237	763060L	*	258
7613CR	**	141	762040L	*	257	763060Y	*	351
7613CW	**	141	762040Y	*	351	763080	*	10
7613DG	**	141	762050	*	10	763080J	*	278
7613DR	**	141	762050J	*	277	763080K	*	237
7613DW	**	141	762050K	*	237	763080L	*	258
7614/D	*	161	762050L	*	257	763080Y	*	351
7614/S	*	161	762050Y	*	351	763099	*	10
7615	**	140	762060	*	10	763099J	*	278
7615CG	**	140	762060J	*	277	763099K	*	237
7615CR	**	140	762060K	*	237	763099L	*	258
7615CW	**	140	762060L	*	257	763099Y	*	351
7615DG	**	140	762060Y	*	351	7632	*	106
7615DR	**	140	762080	*	10	7633	*	103
7615DW	**	140	762080J	*	277	7639/H	*	27
7616	**	142	762080K	*	237	764000	*	10
7616CW	**	142	762080L	*	257	764000J	*	277
7616DW	**	142	762080Y	*	351	764000K	*	237
7617	**	142	762099	*	10	764000L	*	257
7617CW	**	142	762099J	*	277	764000Y	*	351
7617DW	**	142	762099K	*	237	764015	*	10
7618	**	147	762099L	*	257	764015J	*	277
7618AG	**	147	762099Y	*	351	764015K	*	237
7618CN	**	147	7626	*	1	764015L	*	257
7618CR	**	147	7626J	*	279	764015Y	*	351
7618CW	**	147	7626K	*	238	764020	*	10
7618RA	**	147	7626L	*	259	764020J	*	277
7618U	**	147	7626W	*	312	764020K	*	237
7619	**	147	763000	*	10	764020L	*	257

Codice Articolo	Euro	Pag List	Codice Articolo	Euro	Pag List	Codice Articolo	Euro	Pag List
764020Y	•	351	805107	••	F/C	8149	••	451
764025	•	10	805115	••	F/C	8150	••	451
764025J	•	277	805120	••	F/C	8151J	••	448
764025K	•	237	805130	••	F/C	8151K	••	448
764025L	•	257	8058	••	445	8151L	••	448
764025Y	•	351	8058G	••	CG22	8151R	••	448
764030	•	10	8058R	••	445	8151V	••	448
764030J	•	277	8059	••	445	8152J	••	445
764030K	•	237	8059G	••	CG22	8152K	••	445
764030L	•	257	8059R	••	445	8152L	••	445
764030Y	•	351	8060	••	445	8152R	••	445
764040	•	10	8060G	••	CG22	8152V	••	445
764040J	•	277	8060R	••	445	8158	••	451
764040K	•	237	8088	••	450	8158K	••	451
764040L	•	257	8088A	••	450	8158V	••	451
764040Y	•	351	8093	••	445	8159	••	450
764050	•	10	8093G	••	CG22	8159J	••	450
764050J	•	277	8093R	••	445	8159K	••	450
764050K	•	237	8094	••	445	8159L	••	450
764050L	•	257	8094G	••	CG22	8159R	••	450
764050Y	•	351	8094R	••	445	8159V	••	450
764060	•	10	8095	••	445	8161	••	449
764060J	•	277	8095G	••	CG22	8161P	••	449
764060K	•	237	8095R	••	445	8161P01	••	449
764060L	•	257	8097	••	442	8162J	••	449
764060Y	•	351	8098	••	442	8162K	••	449
764080	•	10	8099	••	442	8162L	••	449
764080J	•	277	8100	••	451	8162P	••	449
764080K	•	237	8101	••	451	8162P03	••	449
764080L	•	257	8108	••	442	8162R	••	449
764080Y	•	351	8109	••	442	8162V	••	449
764099	•	10	8111	••	451	816320	••	443
764099J	•	277	8112	••	451	816330	••	443
764099K	•	237	8113	••	CG22	816408	••	443
764099L	•	257	8115	••	442	816413	••	443
764099Y	•	351	8119	••	442	816518	••	443
764305	•	123	8121G	••	CG22	8169	••	442
764307	•	123	8122	••	442	8170	••	442
7644 P	•	105	8125	••	442	8172B	••	444
764411 P	•	105	8126G	••	CG22	817208	••	444
7645	•	17	8126U	••	442	81725SAT	••	444
7647	•	127	8127	••	440	8173	••	444
7648U	•	125	8129	••	440	8174W	••	444
764860U	•	125	8130	••	440	8175BLU	••	447
7649U	•	127	8131	••	440	8175GR	••	447
764950U	•	127	-8132	••	440	8175RED	••	446
764960U	•	127	8133	••	442	8175TB	••	446
764970U	•	127	8133G	••	CG22	8175W	••	447
7650/H	•	27	8133J	••	448	8176BE	••	446
7651	•	361	8133K	••	448	8176W	••	446
7652	•	361	8133L	••	448	8177	••	446
7653	•	361	8133R	••	448	8178	••	446
7654	•	361	8133U	••	442	8179	••	447
7655	•	361	8133V	••	448	8180	••	447
7656	•	361	8134	••	442	8181	••	447
7826	•	1	8135G	••	CG22	8182	••	446
7826J	•	279	8136	••	440	8183	••	446
7826K	•	238	8137	••	441	8184	••	447
7826L	•	259	8138	••	441	8185	••	447
8000	••	CG22	8139	••	441	8186	••	447
8027	••	441	8140	••	441	8187	••	446
8038	••	441	8144	••	451	8188	••	447
8040	••	443	8145	••	441	8801	••	452
8046	••	450	8146	••	441	8802	••	452
8046A	••	450	8147	••	441	8802/L	••	452
8050	••	443	8148	••	442	8802/R	••	452

Codice Articolo	Euro	Pag List
8803	..	452
8804	..	452
8805	..	452
8806	..	452
8999	..	454
8999A	..	F/C
8999B	..	F/C

Codice Articolo	Euro	Pag List
8999C	..	F/C
8999D	..	F/C
8999E	..	F/C
8999F	..	F/C
8999G	..	F/C
8999H	..	F/C
8999L	..	F/C

Codice Articolo	Euro	Pag List
8999M	..	F/C
899901	..	454
899902	..	454
899903	..	454
899904	..	454

RICAMBI

FIAMME: pag.342-343		GRIGLIE: pag.99		VITI: pag. 36-37		LUMINI: pag. 344-345					
Ricambio	Euro	Ricambio	Euro	Ricambio	Euro	Ricambio	Euro	Ricambio	Euro	Ricambio	Euro
A/01		I/01		M/29		M/74-8		P/10		P/53**	
A/02		I/02		M/29-6		M/75		P/11		P/53-A	
A/04		I/05		M/29-8		M/76-8		P/12		P/53-B	
B/01		I/06		M/30		M/77		P/14		P/54	
B/02		I/07		M/31		M/79		P/15		P/55	
B/03		I/08		M/31L		M/80		P/16		P/56	
B/04		I/10		M/32-L		M/81-L		P/17		P/57	
B/05		I/11		M/32-P		M/81-P		P/17**		P/59	
B/06		I/12		M/33-A		M/82-L		P/17D		P/59**	
B/08		I/13		M/33-B		M/82-P		P/17DY		P/59-A	
B/09		I/14		M/33-P		M/84-L		P/18		P/59-AB	
B/10		I/15		M/34		M/84-P		P/19		P/59-AK	
B/11		LM1		M/35		M/86-L		P/19**		P/59-AN	
B/12		LM1B		M/36-F		M/86-P		P/20		P/59-AP	
B/13		LM1BH		M/36-L		M/8616-L		P/20**		P/59-AZ	
BA/1		LM1F		M/37		M/8616-P		P/21		P/59-B	
BG/1		LM1FB		M/37STR		M/89-L		P/21**		P/59-BB	
BG/3		LM1FM		M/38		M/89-P		P/21RA		P/59-BK	
BG/5		LM1M		M/38-6		M/92		P/22		P/59-BZ	
BR/1		LM10		M/38E		M/93BD		P/22**		P/59-D	
BR/2		LM10BH		M/39		M/95BD		P/23		P/59-DB	
CF40		LM2		M/39-8		M/96-F		P/23**		P/59-DK	
CF41		LM2B		M/40		M/96-P		P/25		P/59-DN	
F/01		LM2BH		M/41-A		M/97		P/25**		P/59-DZ	
F/01L		LM2F		M/41-P		M/98		P/26		P/59AG	
F/02		LM2FB		M/41-8		MCV/98		P/26**		P/59BG	
F/02G		LM2FM		M/42		P/A1		P/27		P/59GR	
F/02L		LM2M		M/43-F		P/A10		P/27**		P/59GR**	
F/03		LM6		M/43-L		P/A11		P/28		P/60	
F/03L		LM6BH		M/44		P/A13		P/28**		P/60BR	
F/04		LM7		M/45		P/A14		P/28-C		P/61	
F/08		LM7BH		M/46		P/A14**		P/28A		P/62	
F/10		LM8		M/47		P/A14**B		P/28GR		P/62**	
F/1003		LM8B		M/48		P/A14**K		P/2801		P/63	
F/1003B		LM8F		M/48-8		P/A14**Y		P/2802		P/63**	
F/1003D		LM8FB		M/49		P/A14**Z		P/29		P/63-A	
F/1003G		LM8FM		M/50		P/A19CUT		P/29**		P/64	
F/100304		LM8M		M/51		P/A2		P/29**B		P/65	
F/1008		LM9		M/52		P/A2**		P/29**K		P/65**	
F/1009		LM9B		M/54		P/A2**Z		P/29**Y		P/65*A	
F/12		LM9BH		M/54-8		P/A2A*		P/29**Z		P/65A	
F/22		LM9F		M/55		P/A3		P/29-A		P/65A*	
F/23		LM9FB		M/56		P/A3B		P/2901		P/65AA	
F/24		LM9FM		M/57		P/A3K		P/30		P/65ACUT	
F/25		LM9M		M/58		P/A3N		P/31		P/6501A	
F/26		M/02		M/58-L		P/A3Y		P/32		P/66	
F/27		M/03		M/59		P/A3Z		P/35		P/66**	
F/28		M/04		M/59-8		P/A4		P/36		P/66*A	
F/30		M/05		M/60		P/A401		P/37**		P/67	
F/31		M/06		M/60-L		P/A7		P/38		P/68	
F/32		M/06-P		M/60-8		P/A73		P/38GR		P/70	
F/993		M/07		M/61-F		P/A73SG		P/3809		P/70**	
F/993B		M/08		M/61-L		P/A74		P/39		P/70**B	
F/993D		M/09		M/64-6		P/A74B		P/39A		P/70**K	
F/993G		M/11		M/64-8		P/A74K		P/43		P/70**N	
F/998		M/12		M/65		P/A74Z		P/43**		P/70**Y	
F/998B		M/13		M/66		P/A8		P/43**B		P/70**Z	
F/998D		M/14		M/67		P/A9		P/43**K		P/70-A	
F/998G		M/16		M/67-8		P/01		P/43**Y		P/70-B	
F/99804		M/18		M/68		P/01**		P/43**Z		P/70-C	
G/01		M/20-F		M/69		P/02		P/43*A		P/71	
G/02		M/21-F		M/69P		P/03		P/43A*		P/71**	
G/03		M/21-L		M/70		P/03**		P/43AA		P/71-A	
G/04		M/22		M/71		P/04		P/43ACUT		P/71-B	
G/08		M/23		M/72		P/05		P/50		P/71-C	
G/09		M/24		M/73-F		P/06		P/50AV		P/72	
G/10		M/26		M/73-P		P/07		P/52		P/72**	
G/10P		M/27-8		M/74		P/08		P/53		P/72**H	

Ricambio	Euro	Ricambio	Euro	Ricambio	Euro	Ricambio	Euro	Ricambio	Euro	Ricambio	Euro
P/72-A		R/A3P		R/53		R/88-AN		S/32FUMEL		V/06	
P/72-AH		R/A3Z		R/54		R/88-AZ		S/32FUMEP		V/07	
P/72-C		R/A5		R/55		R/88-B		S/33AF		V/10	
P/72-CB		R/A7		R/56		R/88-BB		S/33AL		V/11	
P/72-CK		R/B1		R/57		R/88-BN		S/35FUMEF		V/12	
P/72-CY		R/B3		R/58		R/88-BZ		S/35FUMEP		V/13	
P/72-CZ		R/B3B		R/59		R/88-C		S/36FUMEF		V/18	
P/7201		R/B3H		R/60		R/88-D		S/36FUMEP		V/19	
P/7202		R/B3K		R/61		R/88-DB		S/37FUMEF		V/20	
P/73		R/B3Z		R/61N		R/88-DK		S/37FUMEP		V/21	
P/73**		R/B4		R/62		R/88-DN		S/40B		V/22	
P/73**H		R/01		R/63		R/88-DZ		S/40G		V/26	
P/73**8		R/02		R/64		R/89		S/42B		V/27	
P/73-A		R/03		R/65		R/90D		S/42G		V/28	
P/73-AB		R/04		R/66		R/91		S/43		V/32	
P/73-AK		R/05		R/67		R/92		S/43B		V/33	
P/73-AZ		R/06		R/68		R/93		S/43G		V/34	
P/74		R/07		R/68B		R/93**		S/44BF		V/35	
P/74**		R/08		R/68K		R/93**B		S/44BL		V/38	
P/74-C		R/08B		R/68N		R/93**N		S/44GF		V/42	
P/75		R/08K		R/68Z		R/93**Z		S/44GL		V/43	
P/75**		R/08N		R/69		R/93-A		S/45B		V/44	
P/75A*		R/08Z		R/69D		R/93-AB		S/45G		V/45	
P/75K		R/09		R/70		R/93-AH		S/46G		V/47	
P/75N		R/10		R/70**		R/93-AK		S/47G		V/48	
P/75Z		R/11		R/70**B		R/93-AP		S/48B		V/49	
P/76		R/12		R/70**N		R/93-AZ		S/48G		V/51	
P/77		R/13		R/70**Z		R/93-B		S/49B		V/52	
P/77**		R/14		R/70-A		R/95		S/49G		V/53	
P/79		R/16		R/70-B		R/97		S/50B		V/54	
P/79**		R/17		R/70-C		R/97B		S/50G		V/55	
P/80		R/18		R/71		R/97K		S/51B		V/56	
P/82		R/19		R/71**		R/97N		S/51G		V/57	
P/83		R/20		R/71**N		R/97Z		S/53B		V/58	
P/83AV		R/21		R/71-A		S/01V		S/53G		V/59	
P/84		R/22		R/71-AN		S/02		S/54B		V/60	
P/85		R/23		R/71-B		S/05B		S/54G		V/61	
P/87		R/24		R/71-C		S/05G		S/58B		V/65-S	
P/87AV		R/24D		R/72		S/08B		S/58G		V/78	
P/87VE		R/25		R/72N		S/08G		S/60B		V/79	
P/88		R/25-N		R/73		S/10		S/60B-K		V/80	
P/88**		R/26		R/73-A		S/11B		S/60G		V/81	
P/88-A		R/27		R/73N		S/11G		S/60G-K		V/82	
P/89		R/27D		R/74		S/12B		S/61		V/83	
P/89**		R/28		R/75		S/12G		S/62B		V/84	
P/89**H		R/28D		R/77		S/13B		S/62G		V/85	
P/91		R/29		R/77**		S/13G		S/64B		V/86	
P/92		R/30		R/77**B		S/14		S/64G		V/87	
P/92**		R/31		R/77**K		S/15		S/66FUME		V/88	
P/92-A		R/32		R/77**N		S/15-A		S/72B		V/90	
P/92-AB		R/33		R/77**Z		S/16		S/72G		V/91	
P/92-AK		R/34		R/78		S/16-A		S/73BF		V/91F	
P/92-AZ		R/35		R/79		S/17		S/73BL		V/92	
P/93		R/36		R/80D		S/17B		S/73GF		V/94	
P/96		R/37		R/81		S/17G		S/73GL		V/96	
P/96**		R/38		R/81K		S/19		S/75		V/97	
P/97		R/39		R/82		S/22		S/75B		V/98	
P/99		R/39T		R/83		S/23		S/75G		VA/01	
PFR009		R/40		R/84		S/24		S/76		VA/12	
PFT002		R/41		R/85		S/25		S/76B		VA/13	
PFT006		R/43		R/86		S/26FUMEF		S/76G		VA/20	
PFT008		R/45		R/87		S/26FUMEL		S/77		VA/21	
R/A1		R/46		R/88		S/26FUMEM		S/80FUMEF		XB/1	
R/A10		R/47		R/88**		S/27FUME		S/80FUMEP		XB/2	
R/A3		R/48		R/88**H		S/28FUME		V/01		XB/3	
R/A3B		R/49		R/88**P		S/29		V/02		XB/4	
R/A3H		R/50		R/88-A		S/30FUME		V/03		XR/1	
R/A3K		R/51		R/88-AB		S/31		V/04		XR/2	
R/A3N		R/52		R/88-AK		S/31FUME		V/05		XR/3	

LAVORAZIONI SPECIALI

LS/1	■	AUMENTO X FILETTO CORNICE INOX
LS/2	■	AUMENTO X FILETTO CORNICE BRONZO
LS/3	■	FORATURA BICCHIERI
LS/4	■	AUMENTO TUBO FILETTATO LAMPADA
LS/5	■	AUMENTO X FILETTO LETTERE
LS/6	■	SALDATURA PERNO BORCHIE
LS/8	■	PERNI LUNGHİ SU CORSIVO SALDATO
LS/14	×	PROVA SU CARTA
LS/15P	■	AGGIUNTA APPLICAZIONE GRANDE ALLA CROCE
LS/15G	■	AGGIUNTA APPLICAZIONE PICCOLA ALLA CROCE/COFANETTO LEGNO
LS/16	■	INCLINAZIONE CORNICI ACCIAIO/BRONZO
LS/17	■	MONTAGGIO BRACCETTO A PARETE X VASI E LAMPADE
LS/19	■	CERNIERA X CORNICI BRONZO/ACCIAIO
LS/20	■	TRASFORMAZIONE CORNICI NON SALDATE IN ORIZZONTALE
LS/21	■	TRASFORMAZIONE CORNICI SALDATE IN ORIZZONTALE
LS/22	■	RIDUZIONE X FIAMME (RAGNETTI)
LS/23	■	PORTAPILE PER LM6
LS/24	■	INCISIONE LOGHI E SIMBOLI SPECIALI SU PERGAMENA O TARGA

ARTICOLI CROMATI-MERCURIO-DORATI-CUBICATI

ARTICOLI LUCIDATI A SPECCHIO

ARTICOLI SATINATI

ARTICOLI GREZZI

ARTICOLI SMALTATI X PORCELLANA (W)

ARTICOLI IN PATINA POMPEIANA

ARTICOLI IN ALTRA PATINA

L'AZIENDA SI RISERVA DI VERIFICARE LA FATTIBILITA' DELLA RICHIESTA

Caratteri e misure disponibili SCRIPTA

Available SCRIPTA characters and sizes

h cm	Scaligero	Normanno	Romano	Moderno altorlievo	Bastone	Moderno	Century	Simplex inox	Romano inox	Scaligero inox
1,5	•		•				•			
2			•		•					
2,5	•	•	•		•	•	•	•	•	•
2,7										
3	•	•	•	•	•	•	•			
3,5								•	•	
4	•	•	•	•	•	•	•			•
4,5								•	•	
5	•	•	•	•	•	•	•			
5,5								•	•	
6		•	•			•				
7	•									
8		•	•	•						
10										

INFORMAZIONI UTILI • USEFUL INFORMATION

TABELLA DIMENSIONI LETTERE CORSIVO SALDATO/AUTOCOMPONIBILE DIMENSIONS OF CURSIVE SOLDERED/AUTOCOMPOSIBLE LETTERS

Art. 2051-2723 (H. mm. 25)										Art. 2054-2724 (H. mm. 50)							
Larghezze (mm.) - Width (mm.)										Larghezze (mm.) - Width (mm.)							
A	33	H	33	Q	31	J	20	3	24	A	76	H	80	Q	45	J	42
B	33	I	22	R	27	Y	37	4	26	B	66	I	40	R	80	Y	40
C	26	L	26	S	25	K	35	5	25	C	35	L	61	S	40	K	77
D	33	M	56	T	24	X	41	6	23	D	60	M	92	T	35	X	63
E	25	N	42	U	35	W	49	7	23	E	42	N	59	U	55	W	58
F	28	O	30	V	38	1	24	8	20	F	40	O	43	V	35		
G	34	P	36	Z	30	2	27	0	20	G	43	P	43	Z	62		

NOTE GENERALI PER LETTERE SCiolTE

Per quantità inferiori alla confezione e forniture di diciture, aumento del 20% fino a 6 cm. Legenda simboli:

- Lettere / * Numeri / ✱ Stelle (70) - Croci (69) / ■ Stelle (68) - Croci (67) / + Alpha (66) - Omega (33)
- Letters / Figures / Stars / Crosses / Stars / Crosses

NOTES FOR LOOSE LETTERS

20% surcharge for any order less than the minimum requirement and for specific words up to 6 cm. Symbols:

NOTE GENERALI PER LETTERE TRAFORATE

Nelle ordinazioni indicare sempre l'altezza della vocale minuscola: il prezzo verrà calcolato in base all'altezza della vocale minuscola. Spessore: 3 mm. Per spessore superiore a 3 mm chiedere preventivo.

NOTES FOR LASER-CUT LETTERS (TRAFORATO)

The height of the small letters must always be mentioned on the order: the price will be calculated on this basis. Thickness: 3 mm. For extra thickness please ask for a quote.

CARATTERI DISPONIBILI PER INCISIONE LIBRI E PERGAMENE AVAILABLE FONTS FOR ENGRAVING ON BOOKS AND PARCHMENTS

TIPO	
"CD"	<i>Abcdef</i>
"BM"	ABCDEFGFG
"BL"	ABCDEF
"BS"	ABCDEFGFGH

CARATTERI DISPONIBILI PER TARGHE CON SCRITTA RILIEVO (pag. 19 e 313) AVAILABLE FONTS FOR PLAQUES WITH RELIEF LETTERS

TIPO	
"BM"	ABCDEFGFG
"BS"	ABCDEFGFGH
"BL"	ABCDEF
"RL"	ABCDEFGFGH

MISURE DI INGOMBRO LETTERE EPOCA • DIMENSIONS OF EPOCA LETTERS

Art. 7358 Art. 7473											
	A D H N R W	B	C	E	F J Q S Y Z	G T V	L P U	M	O I	X K	
Art. 7359 Art. 7474											
	a d g u p q v n	b e c s	f l	yz h x	w m	t j	r o k u	i			

CURA LA NOSTRA QUALITÀ CARE OF OUR QUALITY



ARTICOLI IN BRONZO - OTTONE E FINITURE CUBIC SMALTATO BIANCO - BRILLIANT BLACK - MERCURIO PALLADIO

1. Per la pulizia utilizzare solamente panni morbidi e acqua.

L'utilizzo di panni ruvidi può danneggiare la finitura del prodotto e favorirne l'ossidazione.

Si consiglia l'utilizzo del nostro Spray lucidante e conservante LUXOR a base di cera. Non utilizzare prodotti chimici generici.

2. Per il montaggio **NON UTILIZZARE SILICONE ACETICO** e maneggiare con cura.

I prodotti verniciati sono delicati. L'impatto con superfici rigide può danneggiare lo strato protettivo alterando di molto la tenuta alle ossidazioni.

3. I prodotti in bronzo ed ottone tendono ad ossidarsi naturalmente. Seguire le istruzioni sopra riportate per ritardarne l'effetto.

BRONZE - BRASS ARTICLES AND CUBIC - WHITE ENAMEL BRILLIANT BLACK - MERCURIO - PALLADIO FINISHING

1. For cleaning use soft cloths and water only.

Rough cloths might damage the product surface and enhance oxidation.

We recommend our LUXOR polishing and wax base Spray and preservative. Do not use unbranded chemical products.

2. When mounting, **DO NOT USE ACETIC SILICONE** and handle with care. Painted products are delicate.

Contact with hard surfaces might damage the protective layer and accelerate oxidation.

3. Bronze and brass articles tend to oxidate naturally. Please follow the above instructions to delay this effect.

ARTICOLI IN ACCIAIO INOSSIDABILE

1. Lavare gli articoli inox con l'utilizzo di una spugnetta o un panno morbido.

Utilizzare acqua, detersivo neutro oppure prodotti specifici per la pulizia e manutenzione dell'acciaio reperibili in commercio, facendo attenzione che tali prodotti non entrino in contatto con le superfici di marmo sulle quali normalmente sono fissati gli articoli.

Non utilizzare spugne o panni abrasivi che potrebbero rigare la superficie e favorire il deposito di pollini, smog e polvere.

STAINLESS STEEL ARTICLES

1. Wash stainless steel items with a soft cloth.

Use water, neutral detergents or specific products for steel cleaning and maintenance which are commercially available, make sure they do not touch the marble slab on which the articles are normally mounted.

Do not use abrasive cloths which might scratch the surface and enhance pollen, smog and dust deposition.



Fusione a cera persa  Lost wax casting

Fusione a terra  Sand casting

Ossari  Columbaria

Codice articolo  **Art. 7257L** Article Code
Descrizione articolo **h. 21 x 10 x 9 F/12** Description

Tutti i lumini/ceri rappresentati nelle foto dimostrative delle lampade non sono inclusi nel prezzo.

All battery lights/wax candles depicted in the candleholders are not included in the price

Legenda codice articolo		Code Legend	
Attacco a parete		Wall mounted	
Attacco a terreno		Base mounted	
Vasca a parete semicircolare		Semicircular wall mount. bowl	
Legenda descrizione articolo		Description Legend	
Fusione a terra	-	Sand casting	
Dimensioni		Dimensions	
altezza [h.]	1	st dimension = height [h.]	
larghezza	2	nd dimension = width	
profondità	3	rd dimension = depth	
Base		Base	
larghezza	1	st dimension = width	
profondità	2	nd dimension = depth	
Sezione		Section	
dimensione sezione tonda	Ø	dimension of round section	
dimensione sezione quadra	⊠	dimension of square section	
Ricambi		Spare Parts	
contenitore per acqua in rame	R/	copper vase insert	
contenitore per acqua in plastica	P/	plastic vase insert	
contenitore per acqua in acciaio inox	I/	stainless steel vase insert	
contenitore per acqua in alluminio	A/	aluminium vase insert	
fiamma	F/	glass dome	
vetro molato	M/	bevelled glass	
vetro stampato	S/	moulded glass	
griglia	G/	grill for flower separation	
bicchieri	B/BG/	glass	

Adattabile all'accessorio con lucchetto Art. 4000.  Padlock Art. 4000 applicable.

Predisposta per lucchetto  Provided with metal tongue for lock.

©2013 BIONDAN S.p.A.

Tutti i disegni, modelli e stampe sono di esclusiva proprietà della BIONDAN S.p.A. e quindi sono tutelati dalle norme in materia di diritto d'Autore. La loro riproduzione parziale o totale è pertanto vietata.

©2013 BIONDAN S.p.A.

All drawings, models and moulds are the exclusive property of BIONDAN S.p.A. and are copyright by International Law. Total or partial reproduction is prohibited.

LEGENDA PAGINA CATALOGO

I numeri di pagina si riferiscono al presente catalogo, salvo i seguenti casi

- **pagine che iniziano con CG:**
si riferiscono ai numeri di catalogo precedenti;
- **pagine che iniziano con CS:**
si riferiscono ai numeri di supplemento precedenti;
- **pagine che iniziano con D:**
si riferiscono a depliant aggiuntivi;
- **pagine NVO:**
novità, ancora non fotografate sul catalogo;
- **pagine F/C, F/S, 0000:**
articoli non disponibili su cataloghi fotografici.

CONDIZIONI GENERALI DI VENDITA

1. Vendite

Le vendite vengono effettuate alle condizioni generali della Ditta che non potranno essere modificate se non dalla medesima con esplicito atto scritto. Tutte le vendite s'intendono fatte "salvo approvazione della venditrice" che entro quindici giorni dalla data della conferma può comunicare per iscritto l'eventuale decisione di rifiutare l'ordine.

2. Consegna

a) Tutte le spedizioni vengono eseguite nel termine di circa otto giorni dal ricevimento dell'ordine.

b) Il termine di consegna è solamente indicativo e non tassativo, esso pertanto non costituisce condizione essenziale del contratto.

c) La sua determinazione si effettua a giorni lavorativi a decorrere dal momento in cui sono stati definiti tutti gli elementi dell'ordinazione e semprechè sia stato effettuato il pagamento di quanto convenuto.

d) Detto termine s'intende adeguatamente prorogato di diritto per effetto di avvenimenti indipendenti dalla volontà della venditrice; comunque in nessun caso il committente potrà vantare danni o altro indipendenti da ritardata consegna.

3. Resa della merce

I prezzi si intendono sempre per merce resa Franco nostro magazzino di Montorio Veronese. La merce viaggia sempre a rischio e pericolo del committente anche quando venduta Franco Destino, e gli eventuali ritardi, rotture, manomissioni e perdite della merce, non potranno in nessun caso dare luogo a risarcimento danni.

4. Dati tecnici

Le illustrazioni, le misure e tutti i dati caratteristici risultanti dai cataloghi, debbono essere considerati approssimativi essendo notificati dalla venditrice a puro titolo informativo e senza responsabilità. La venditrice si riserva la facoltà di apportare modifiche senza obbligo di preavviso.

5. Pagamento

Il pagamento se non diversamente pattuito è inteso "Contrassegno". Tutte le spese postali, imballo, tassa rimborso assegno, ecc. sono a esclusivo carico del committente. Per qualsiasi ordinazione di articoli speciali non esposti in catalogo sarà necessario un versamento anticipato del 50%.

Tutti gli altri pagamenti dovranno essere effettuati al domicilio della fornitrice nel modo pattuito. Nonostante siano convenuti pagamenti a mezzo tratte autorizzate, cambiali od assegni bancari, il domicilio della fornitrice rimane fermo come luogo di pagamento. Ogni ritardo nel pagamento dà luogo alla immediata decorrenza dell'interesse commerciale maggiorato del 3% annuo.

6. Reclami o contestazioni

Ogni eventuale reclamo dovrà pervenire alla fornitrice entro otto giorni dal ricevimento della merce da parte del committente; i reclami per rotture o mancanze rispetto al buono di consegna, debbono essere fatti al vettore all'atto del ricevimento. Il reclamo non esonera il committente dall'obbligo di ritirare altra merce regolarmente ordinata e pronta per la consegna, né di ridurre o sospendere il pagamento che si è obbligato a fare al domicilio della fornitrice.

7. Restituzione

Non verrà accettata merce di ritorno, se non in porto franco e sempre dietro autorizzazione scritta della ditta fornitrice. In ogni caso la ditta fornitrice si riserva di addebitare al cliente ogni spesa di controllo, immagazzinaggio e ripristino del materiale restituito.

8. Garanzia

La ditta fornitrice garantisce la buona qualità e costruzione del materiale. La ditta fornitrice si impegna a sostituire solamente quel materiale che risultasse difettoso per carenze di costruzione o di qualità. È espressamente escluso il risarcimento di ogni eventuale diverso o maggior danno.

9. Controversia

Per ogni eventuale controversia o contestazione sarà competente l'autorità giudiziaria di Verona, né tale competenza potrà essere derogata per ragione alcuna di competenza accessoria o connessione di lite.

Avvertenza:

Tutti i disegni, modelli e stampi sono di esclusiva proprietà della Biondan Spa e quindi sono tutelati dalle norme in materia di diritto d'Autore. La loro riproduzione parziale o totale è pertanto vietata.

GENERAL SALES CONDITIONS

1. Sales

Sales are made in accordance with the company's general conditions which cannot be changed except by the company itself by means of an explicit written document. All sales shall be subject to the prior approval of the seller who, within fifteen days from the date of confirmation shall be entitled to notify in writing any decision to refuse the order.

2. Delivery dates

a) All shipments are made within thirty days from order receipt.

b) The delivery date is purely approximate and not binding. It is not therefore an essential condition of the contract.

c) The delivery date is determined by working days starting from definition of all the various aspects of the order and as long as all agreed payments have been made. d) Such delivery date shall be considered as adequately extended by right in the event of occurrences beyond the control of the seller. Under no circumstances shall the buyer be entitled to request damages or else as a result of delayed delivery.

3. Delivery conditions

Prices shall always be for goods delivered ex our warehouse. Goods always travel at the buyer's risk, including those sold free destination, and any delays, breakages, tampering with and loss of goods shall under no circumstances entitle the buyer to damages.

4. Technical details

The illustrations, measurements and all data shown in catalogues shall be considered approximate and notified by the seller by way of information only, without any responsibility on the part of the seller. In case one item is produced in different sizes, the picture might not correspond to all sized. The seller reserves the right to make changes without prior notice.

5. Payment

Unless otherwise agreed, payment shall be made COD. All mailing and packaging costs and cheque reimbursement expenses, etc. are at the buyer's account. For any orders relating to special articles not shown in the catalogue, a 50% advance payment shall be required, unless otherwise requested by the seller.

All other payments shall be made to the supplier's address as agreed. Despite agreements being made for payment by authorized drafts, bills of exchange or bank cheques, payment must always be made to the supplier's address. In the event of any delay in payment, commercial interest shall immediately be charged at a rate of 3 percentage points above the official bank rate.

6. Complaints and claims

Any complaints must reach the supplier within 8 days from receipt of goods by the buyer. Claims made as a result of breakages or failure to comply with the delivery note must be made to the carrier upon receipt of goods. Complaints shall not exempt the buyer from the obligation of accepting other goods ordered and ready for delivery, nor shall they entitle him to reduce or suspend payments to be made to the supplier's address.

7. Returned goods

Returned goods cannot be accepted without the prior written agreement of the supplier. In any event, the supplier reserves the right to debit the customer with all costs related to inspection, storage and repair of the returned material.

8. Warranty

The supplier guarantees the good quality and manufacture of the goods. The supplier undertakes to only replace goods with production or quality faults. Under no circumstances shall the supplier be obliged to indemnify other or greater damages. Any faulty items shall be replaced following approval of the supplier. Delivery shall be made ex our works and additional costs are excluded.

9. Disputes

Any disputes shall fall within the jurisdiction of the Court of Verona, without exception for any reasons related to special circumstances or contentious jurisdiction.

Note:

All designs, models and moulds belong to BIONDAN Spa and Kosmolux Srl and are therefore covered by copyright. Any reproduction, either partial or total, is forbidden.





Made in Italy
Established 1956



BIONDAN SPA

Via del Vegron, 2 · 37141 Montorio (VR) - Italy

Tel. +39.045.8950555 · Fax +39.045.8950444

www.biondan.it · biondan@biondan.it

**Scoprite il nostro
video su YOUTUBE**

Discover our video
on YOUTUBE

